



BEAVER 500KG - 10T 3S CHAIN BLOCK

Beaver 3S 500kg, 1T, 2T, 3T, 5T and 10T Chain Blocks are heavy duty industrial blocks designed for heavy lifting and a variety of applications in mining, heavy industrial, major construction works and off shore exploration.

HEAVY DUTY INDUSTRIAL CHAIN BLOCKS

- All steel construction- impact resistant covers, the provide durability and protection
- Double pawl and double guide rollers for enhance performance and reliability
- Unique curling design- This feature enables the hand chain to successfully feed directly into the wheel sprocket from many directions and angles
- Grade 80 load chain – black oxide coating for durability
- Forged alloy steel hooks
- Sealed roller bearings



Lifting



Extraction



Lowering



Manufactured to AS 1418.2 and exceeds standards

Colour Coded to match International Lifting Standards

QR Code on ID Tag

Suitable for Underground Mining (non-conductive materials)

Top & Bottom Hook Ball Bearings

Comprehensive Spare Parts Range & Technical Support



BEAVER 800KG - 9T 3S CHAIN BLOCK

Beaver 3S 500kg, 1T, 2T, 3T, 5T and 10T Chain Blocks are heavy duty industrial blocks designed for heavy lifting and a variety of applications in mining, heavy industrial, major construction works and off shore exploration.

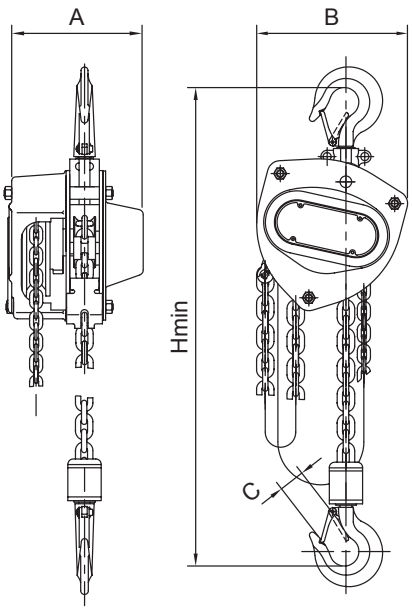

500kg, 1 & 2 tonne

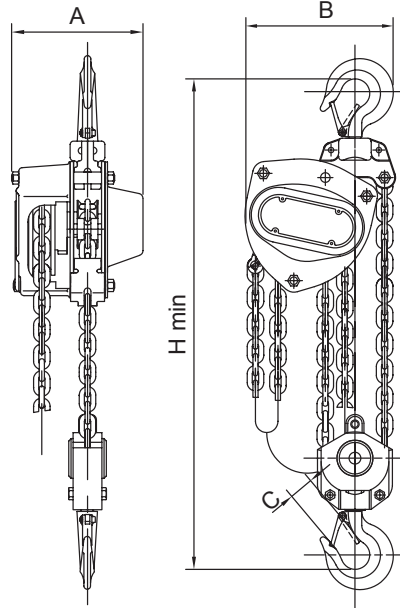

3 & 5 tonne

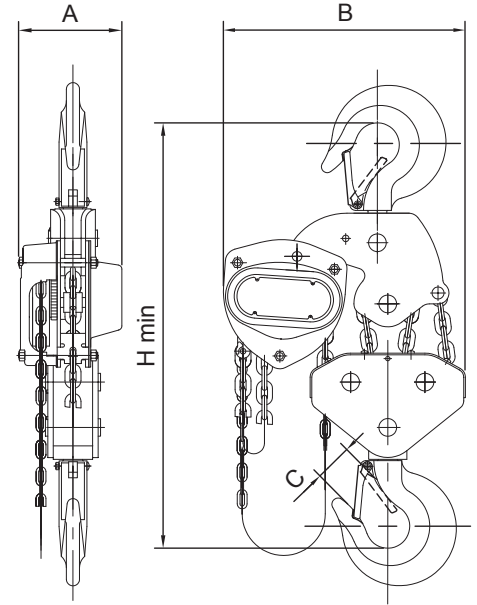

10 tonne

Product Code	503053	503103	503203	503303	503503	508603
Rated capacity (kg)	500	1000	2000	3000	5000	10000
Colour	White	Violet	Green	Yellow	Red	Orange
Standard Lift (m)	3	3	3	3	3	3
Fall of Chain	1	1	1	2	2	4
Efforts to lift full load (N)	240	250	335	335	363	380
Net Weight (kg)	11	12.5	19.5	29	41.3	78.5
Load Chain Diameter (mm)	5x15	6x18	8x24	8x24	9x30	9x30
Extra weight per metre of extra lift (kg)	0.55	0.79	1.38	2.76	4.4	8.8
Headroom (H)	345	376	470	565	688	765
Dimension (mm)						
A	132	151	175	176	189	189
B	148	172	210	230	280	463
C	28	32	36	46	46	57