

DIGITAL PRESET OIL CONTROL GUN

L-DPOCG

Thank you for purchasing a Lubemate L-DPOCG oil control nozzle. Your oil control nozzle has been designed to reliably dispense engine oil, gear oil, automatic transmission fluid and premix automotive coolants. This manual assists in operating and maintaining your new oil control nozzle. Please take a few minutes to read through this manual before installing and operating your new oil control nozzle.

Flexible extension with auto nozzle

Easy access in tight spaces and auto nozzle avoids cross-contamination and fluid wastage.

High accuracy digital oil meter

5 digit easy to read, resettable LCD display.



Presetable oil gun

Offers 5 different dispense memory settings for common delivery volumes.

Robust & light weight design

Ergonomic plastic shell with shockproof rubber & the trigger guard prevents accidental operation.

TECHNICAL SPECIFICATIONS

- ✔ Presetable auto shut-off gun with totaliser and batch counters
- ✔ 1/2" BSP (F) inlet swivel
- ✔ Flow range: 1 - 35LPM
- ✔ Suitable for oils up to SAE 140, engine oils, gear oils, ATF, hydraulic oils and premixed coolants
- ✔ Digital meter: 5 digit easy to read LCD display
- ✔ Max pressure up to 6,900kPa (1000psi)

Mac-rev-1-2018

GENERAL SAFETY REGULATIONS

1. Keep the work area clean and dry. Damp or wet work areas can result in injury.
2. Keep children away from work area. Do not allow children to handle this product.
3. Use the right tool for the job. Do not attempt to force small equipment to do the work of larger industrial equipment. There are certain applications for which this equipment was designed. It will do the job better and more safely at the capacity for which it was intended. Do not modify this equipment, and do not use this equipment for a purpose for which it Was not intended.
4. Check for damaged parts. Before using this product, carefully check that it will operate properly and perform its intended function. Check for damaged parts and any other conditions that may affect the operation of this product. Replace damaged or worn parts immediately.
5. Do not overreach. Keep proper footing and balance at all times to prevent tripping, falling, back injury, etc.
6. DO NOT use the equipment when tired or under the influence of drugs, alcohol, or medication. A moment of inattention while operating this equipment may result in serious personal injury.

TECHNICAL DETAILS

Item No.	L-DPOCG
Flow Range	1-35L/min (0.3-9.2 GPM)
Operating Pressure Range	7-1000 PSI
Operating Temperature	Max. 60°C
Accuracy	±0.5%
Viscosity	8-5000 mPas
5-Digital LCD Display (3/8"H x 3/16"W)	Quart, Pint, Gallon, Liter
Inlet Connection	1/2" BSP (F)
Power Source	1 Alkaline cell 9V

*Tested with DTE-25 motor oil at ambient temperature. Min.-Max. flow range will vary with fluid viscosity.



IMPORTANT!

This manual contains important warnings and information. **READ AND KEEP IT FOR REFERENCE.**

SAFETY PRECAUTIONS



WARNING!

Precaution before installation:

1. Check if there is any data shown on the display.
2. Check if the trigger can work normally.
3. Check if the oil inlet can rotate well.

INTENDED USE

Oil preset meter can be used to dispense motor oil. With the pre-selected function, the nozzle automatically closes the valve and stops dispensing.



WARNING

Read carefully and understand all INSTRUCTIONS before operating. Failure to follow the safety rules and other basic safety precautions may result in serious personal injury. Save these instructions in a safe place and on hand so that they can be read when required. Keep these instructions to assist in future servicing.

FACTORY SETTINGS

- Each meter is preprogrammed and calibrated at the factory. Each meter is programmed in quarts for use with motor oil as standard. The meter is shipped in the Manual Mode.
- The factory preset cannot be changed.

TOOL USE

- DO NOT modify or alter the meter.
- DO NOT leave the meter unattended while dispensing.
- Check the meter daily. Worn or damaged parts should be repaired or replaced immediately.
- DO NOT exceed the maximum working pressure level of the lowest rates system component.
- Use only extensions and nozzles that are compatible with this meter.
- Use only fluids and solvents that are compatible with the equipment. Notice the warnings for fluids and solvents.
- Tighten all fluid connections before operating the meter.
- Comply with all local, state, and federal fire, electrical and safety regulations.
- Use of the product in a manner other than specified in this manual may result in bodily injury or impaired operation or damage to the meter.

OPERATION

The Digital Meter requires 1 Alkaline cell 9V battery to operate (battery included). For battery replacement, refer to Section D, Battery Replacement elsewhere in this manual.

1. Keypad buttons



Press to enter and exit the AUTO Mode.



AUTO

Press to enter and exit the AUTO Mode.



RESET

Press in Manual or AUTO Mode to clear the previously programmed batch and to reset the meter.



OK/STOP

Press to confirm the Valve and to stop the flow through a mechanical override.



2. Installation

Pre-installation procedure

1) Relieve the system pressure

- i) Turn off the power supply to the pump or close the shutoff valve.
- ii) Dispense any fluid in the system into a waste container by opening the dispense valve.
- iii) Open all bleed-type master air and fluid drain valve in the system.
- iv) Leave the drain valve open until ready to pressurize the system.

2) Close the shutoff valve.

3) Ground hoses and reels: Grounding reduces the risk of static sparking; ground all system components according to local, state, and federal codes. Consult the user's manual on the pump and other system components to ground the following:

- i) Pump: follow manufacturer's recommendations.
- ii) Air and fluid hoses: use only grounded hoses.
- iii) Air compressor: follow manufacturer's recommendations.
- iv) Fluid supply container: follow the local code.



WARNING!

Do not use Teflon tape on pipe joints; it may cause a loss of grounding across the joint.

Apply meter to hose

Close the drain valve before starting this procedure.

1. Attach swivel to meter. Apply thread sealant to the male end of the hose. Recommended sealant.
2. Insert the metal end of the hose into the swivel. Tighten completely with an open end adjustable wrench.

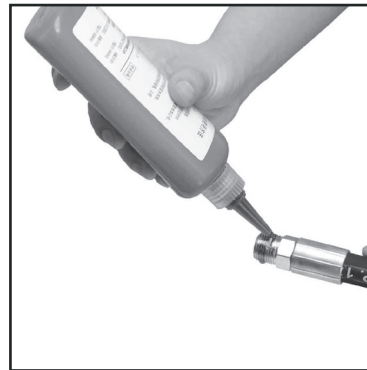

NOTE: The threaded end of the meter always has female threads. The meter end of the hose must have male threads. Apply thread sealant, anaerobic adhesive or equivalents, to the male end. The inlet and outlet swivel connections are 1/2" NPT 1/2" BSP, depending on meter model.

Attach the hose



Apply nozzle to meter



1. On the opposite end, apply sealant to the end of the nozzle.
2. Thread the nozzle onto the meter. Screw it in tightly with an open ended, adjustable wrench.
3. Open all dispense position shut-off-valves. start the pump to pressurize system.
4. Before use to ensure accuracy. Purge all air from the fluid lines and dispense valve(s).



Attach the hose

3. Operating the meter

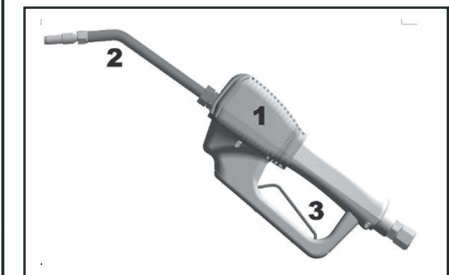
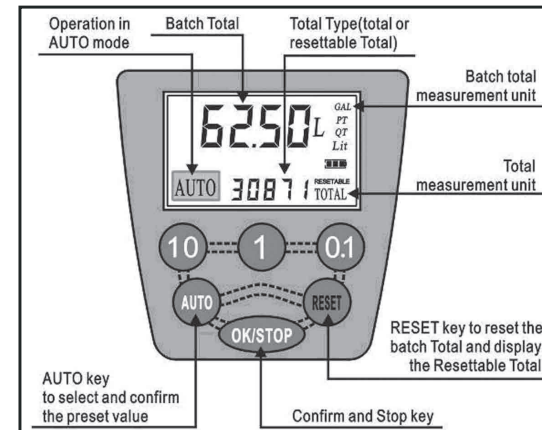

WARNING!

After using the manual anti-drip valve, it is important to discharge the pressure between the chambers (1) and the manual valve (2) of the spout. First, the pump must be switched off. Then, unscrew the tip of the valve (2). During this discharging operation, do not use the trigger (3).

SAFETY PRECAUTIONS

To access the various customizing functions and to select the desired options, **two different actions are indicated on the keys.**

- This symbol indicates that it is necessary to **press (AUTO) briefly**, and afterwards release it.
- This symbol indicates that it is necessary to **press (OK/STOP) and hold on the key** for a few seconds.

To exit from the customization menu, independent of the activity in progress, press **(RESET)**

The settings displayed at that moment immediately become operational.

A. Display Mode
Start up the Meter by selecting



The Meter displays:
Last amount dispensed

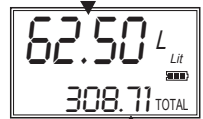

Stored value Total

Press and hold **(RESET)** until the counter reads zero.



The Meter displays: Reset Batch Total



Stored value Total



WARNING!

The stored value total is set as a default in the factory and cannot be changed. If you need to change it, please contact an authorized service center.

B. Operation Mode
B-1. Manual Mode
Program the Meter to Manual Mode by selecting



The Meter displays:



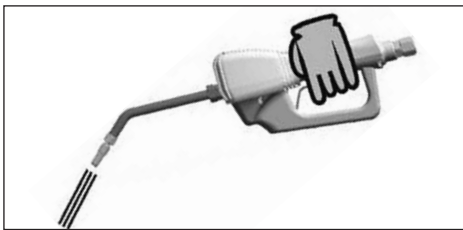

Pull the trigger to dispense.

Pull the trigger to begin the flow. When the desired amount has been pumped, Press **(OK/STOP)** to stop the flow.
Press **(RESET)** to reset counter display to zero.

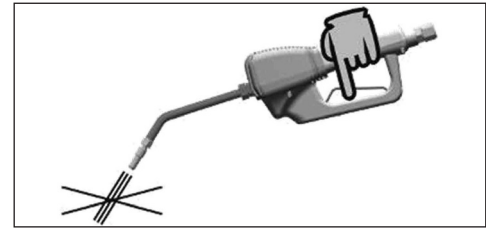

Release the trigger to stop dispensing.

B-2. AUTO Mode
Meter stores: **AUTO**
1-2-3-4-last: Five different PRESET values which are frequently used.

Start up the Meter by selecting **(RESET)**
Press **(AUTO)** as many times as necessary to reach the desired values and the values are repeated.

Blinking message will be:

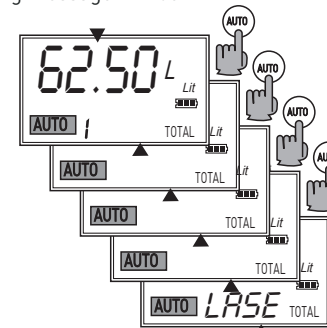

To confirm a PRESET value, press and hold **(OK/STOP)** until the Meter displays:

AUTO message not blinking



Reset Batch Total



To start dispensing, pull the trigger completely, then release.

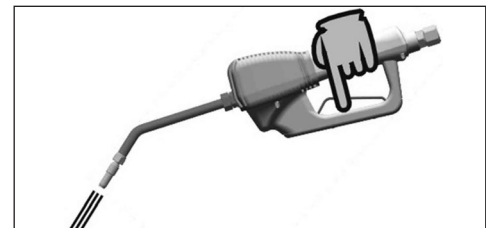

The trigger thus remains locked in open position. Now dispensing can continue in AUTO mode.

Automatic stop

The flow automatically stops when the preset value is reached.

NOTE: If you want to stop dispensing before the preset value is reached, just press to **(OK/STOP)** stop.



WARNING!

WARNING In all cases the operator must attend to the Meter while dispensing in **AUTO mode** in order to avoid any oil spillage.

B-3. User Mode

If the Meter is off, press **RESET**

The value is last amount dispensed, the Meter will display:



Stored Value Total

To select a new PRESET value (for example, 12.3), press the numeric keys as many times as needed; this value will be LAST mode automatically.

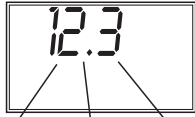

The Meter displays:

Select value

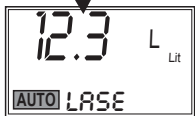

Press **OK/STOP** and hold until the counter turns to zero.

Reset Batch Total



Selected value

To start dispensing, pull the trigger completely, then release. The flow automatically stops when the preset value is reached.

NOTE: If you want to stop dispensing before the preset value is reached, just press **OK/STOP**

B-4. Use The Trigger



Fig A: Pull the trigger completely to start dispensing and the trigger will lock, when the desired amount has been pumped, press the OK/STOP button to release the trigger to stop the flow.

Fig B: If there is only one indicator for the battery left, you need to pull back the trigger manually to stop the oil dispensing

C. Preset Values Setting

C-1. Numeric Function

Press and hold on **OK/STOP** to set the function

Selective key **AUTO**

Numeric keys **10** **1** **0.1**

Confirm and quit key **RESET**

Press and hold on **OK/STOP** to set the function: it contains Value setting [C-2], Unit setting [C-3], Decimal Digits setting [C-4], Reset setting [C-5], Auto reset setting [C-6] and Calibrating setting [C-7].

C-2. Value Setting

The Meter allows the Operator to store 5 different PRESET values (AUTO 1...AUTO 4), which can be recalled without having to set them each time with the numeric keys.

Press and hold **OK/STOP** once to set the function.

The Meter will display:

Blinking



Index of the PRESET value AUTO 1

When the value is blinking, press **AUTO** to select preset 1-4, then press the numeric buttons to set the value.

Blinking message will be:

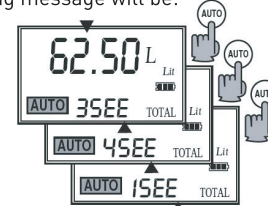

Press **RESET** to confirm the value and quit

the setting mode, the setting value will be stored. By holding on the keys the value continues to vary.

C-3. Unit Setting

The Meter allows the user to select one of the following measurement Units:

- QTS = QUARTS
- PTS = PINTS
- LIT = LITERS
- GAL = GALLONS (U.S. Gallons)

Press and hold **OK/STOP** two times to set the function.



The Meter displays:



When the unit is blinking, press **AUTO** select unit L, GAL, PT or QT.



Press **RESET** to confirm the value and quit the setting mode, the setting value will be stored.



ATTENTION: In order to preserve the unit setting, **OK/STOP** must be held for 2sec after accomplishing setting and programme will be saved until the start of next function setting. If it is necessary to preserve the setting in flash in case of power-off, wait for 30s without operation until the screen disappears and the setting will be written in flash then.

NOTE: The above mentioned measurement units refer to the Batch total indicators.

- If you select the unit LITRES, the **TOTALS will be displayed in LITRES.**
- If you select the unit GALLONS, PINTS or QUARTS, the **TOTALS will be displayed in GALLONS.**
- The modification of the measurement unit does NOT require a new calibration.
- If the TOTAL indicates a value other than zero, this value is automatically converted from one unit to another unit.

C-4. Decimal Digits Setting

Press and hold **OK/STOP** three times to set the function.

The Meter will display:
Blinking point

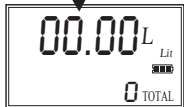

When the number point is blinking, press **AUTO** to select location of the point to confirm the number of decimal digits setting.

Press **RESET** to confirm the value and quit the setting mode. The setting value will be stored.

NOTE:

- The Meter displays the **FLOATING POINT Batch total dispensed**.
- Independent of the selection carried out (two or three decimal digits), as soon as the amount dispensed exceeds 10 units, the Meter displays only **two decimal digits**.
- As soon as the amount dispensed exceeds 99 units, the Meter displays only **one decimal digit**.

C-5. Reset Setting

Press and hold **OK/STOP** four times to set the function.

The Meter displays:
Blinking

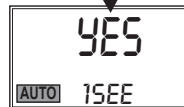

When YES is blinking, press **AUTO** to select YES or No. If YES the batch total will be set to

zero after hold **OK/STOP** button for 10 seconds, NO to cancel.

Press **RESET** to confirm the value and quit the setting mode. The setting value will be stored.

NOTE: Independent of the selection carried out, **the Batch Total supplied is never reset if the dispensing operation has been carried out in AUTO mode.**

C-6. Auto reset setting

The function described in this paragraph concerns **only those who want to obtain the maximum dispensing stop precision in AUTO mode**. If a slight excess of the pre-set value (a few hundredths of a quart) does not cause any problem, the **following paragraphs can be ignored**.

The Meter in AUTO mode allows the user to obtain a highly precise stop, thus dispensing exactly the pre-set amount without exceeding the PRESET value.

To guarantee this high stop precision, especially when the unit operates at the maximum allowed flow rates, dispensing does not stop when the PRESET value is reached, but instead when the PRESET value reaches a few Unit hundredths.

To guarantee the stop precision, this pre-stop value must not be fixed, but is dependent on the flow rate used. To allow the operator to obtain the highest stop precision, the unit is equipped with a Stop Precision factor, called PS factor.

The operator can customize the Meter to select a PS factor between ZERO and FOUR.

WHY CALIBRATE?

If the METER is used:

- **With fluids having a viscosity close to the limits of the allowed range** (such as low-viscosity antifreeze fluids or high-viscosity oils for gear boxes).
- **In extreme flow rate conditions** (close to the min. and max. value of the allowed range), it may be necessary to carry out an on-site calibration.

HOW TO CALIBRATE

The Meter allows the user to carry out a rapid electronic calibration by modifying the **Calibration factor (K Factor)**.

At delivery all meters are given the same calibration factor:

K Factor = 1.000

This calibration factor guarantees the best accuracy in the following operating conditions:

Fluid: Motor oil type 10W 30 Temperature: 68°F Flow-rate: 2.6 GPM

The calibration can be done either as:

- An on-site calibration by dispensing into a calibrated container or
- A direct modification of the calibration factor.

On-site calibration by dispensing into a calibrated container:
Press and hold down **OK/STOP** six times to set the function.

The Meter will display:
Blinking point



Press **AUTO**; start the calibration by dispensing the fluid into a calibrated container.

The dispensing operation may be interrupted and resumed.

The calibrated dispensing is complete when the level of the fluid reaches the graduated area of the calibrated container.

The Meter displays:

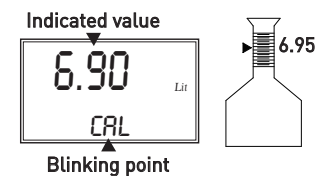

Press **AUTO** dispensing the fluid into a calibrated container.

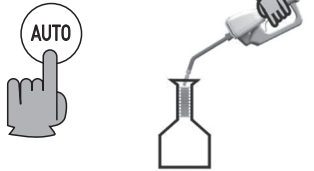

During dispensing the Meter displays:
Batch Total dispensed



Blinking

Press **AUTO** again to modify the value to equal the volume of the calibrated container.

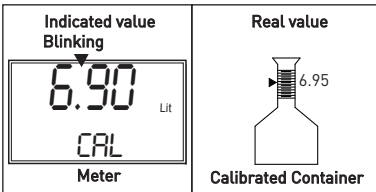

Press key "10" to increase the indicated value.

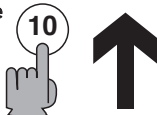

Press key "0.1" to decrease the indicated value.

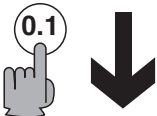

WARNING!
In order to get a correct Calibrated K Factor from the meter, ensure calibration capacity is set to more than 5 quarts. Purge all air from the unit before carrying out the calibration.

Carry out the calibration dispensing at a steady flow rate by pulling the trigger completely and keeping it in the open position until the container is nearly full. Do not reduce the flow rate to reach the graduated area of the calibrated container. Instead, to complete the final stages of the filling operation into the calibrated container, top-off in small increments. This is achieved by rapidly pulling the trigger of the Meter and then releasing it very quickly.



WARNING!
After dispensing, wait a few minutes to allow any air bubbles in the calibrated container to dissipate. Verify the actual amount dispensed in the calibrated container; as the air bubbles dissipate, the indicated level may decrease. Do not wait more than 15 minutes as the Meter will exit from the menu and it will no longer be possible to complete the calibration operation.

The Meter is ready to accept the modification of the indicated value to correspond to the real value. A key each time is pressed, the last digit on the right is modified under one unit.

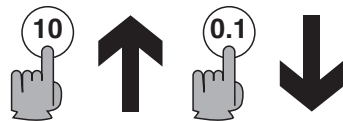

After correction:

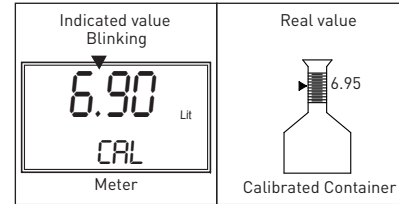

Press **AUTO** again, the Meter will calculate the K Factor automatically which is blinking.

The Meter stores the new Calibration Factor (K Factor) and displays:



Blinking New K Factor

After a few seconds, the Meter automatically exits from the customization mode and starts using the new Calibration Factor.

One dispensing operation is enough to carry out the on-site calibration of the meter. If you wish to verify the result of this calibration, complete a normal dispensing in the same Calibrated Container without re-entering the calibration function in the Customization menu.

Attention: In order to preserve the unit must be held for 2 sec after accomplishing setting and programme will be saved until the start of next function setting. If setting preservation in flash in case of power-off is needed, it is essential to wait for 30s without operation until the screen disappears and the setting will be written in flash then.

D. Battery replacement

9V DC battery is applied for power supply. When voltage is below 6.5V, screen of flowmeter will flash and the meter cannot be used any longer, which means battery must be replaced immediately. Battery replacement must be processed under dormancy mode after screen disappears for the sake of reliable setting preservation.

To replace the batteries:

Pressing "right arrow" and slide to the right.

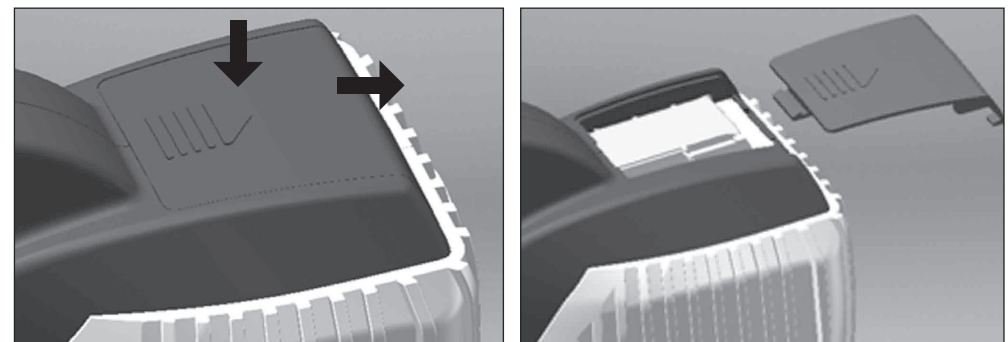

D. Battery replacement

1. To replace the battery, please open the battery cover according to the photo shows.
2. Pull out the battery electrode.
3. Remove the used batteries.
4. Install 1 new 1 Alkaline cell 9V.
5. Replace the cover again.

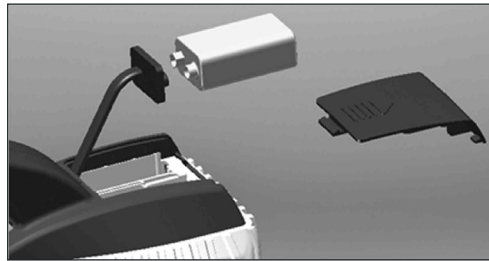

The Meter will start automatically as soon as the battery pack is fixed, carrying out a short SELFTEST:

- Complete lighting of LCD.
- Complete stop of LCD.
- Display of serial number of electronic board.
- Normal operation mode.

The replacement of the batteries does not cause any data loss. The customization of the Meter, previously set, remains operational.

1. If the meter does not operate for more than 30 seconds, it will return to sleep mode.
2. Please pause for more than 30 seconds between reusing AUTO mode.

TROUBLE SHOOTING GUIDE

Problem	Possible Causes	Solutions
Display is Blinking	<ol style="list-style-type: none"> 1. Meter inactive 2. Batteries low or dead 3. Program error 4. Loose battery connection 	<ol style="list-style-type: none"> 1. Press RESET button 2. Replace batteries / Press RESET button 3. Remove and reinsert battery pack / Press RESET button 4. Remove battery pack and check battery connection / Press RESET button
Meter does not latch for batching	<ol style="list-style-type: none"> 1. Meter not in AUTO mode 2. Meter not reset after prior batching 3. Low batteries 	<ol style="list-style-type: none"> 1 Press AUTO button and program batch size 2. Press RESET button 3. Check for battery icon / Replace batteries / Press RESET button

If the meter has anything wrong, please contact an authorized service center.

We don't recommend customers repair the meter themselves.

EXPLORED DRAWING & PART LIST

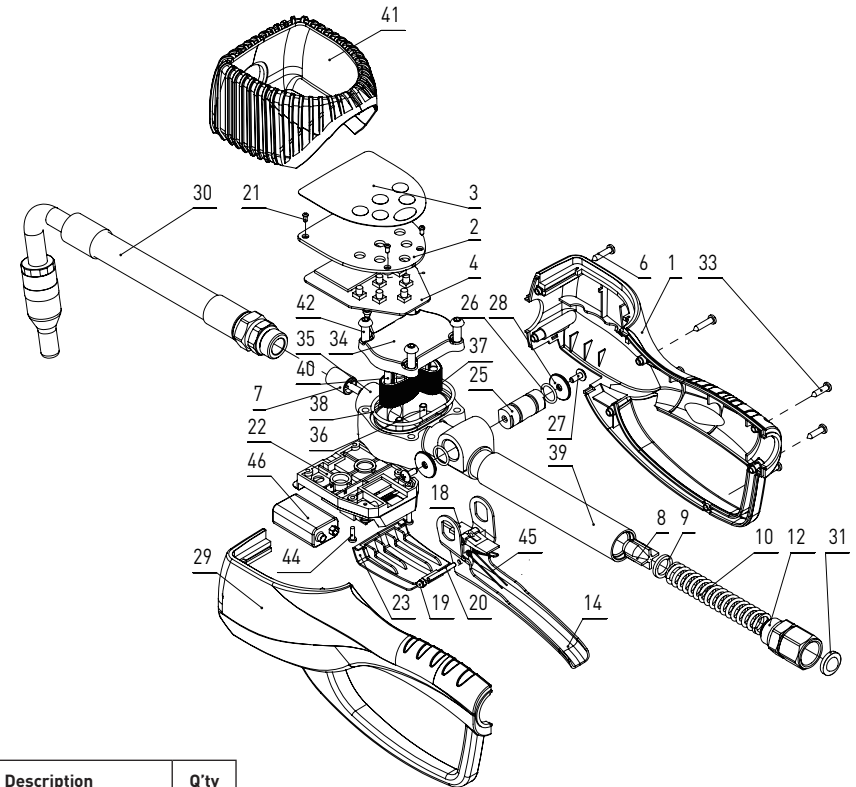

Part No.	Description	Q'ty
1	Right cover	1
2*	Meter cover	1
3*	Front label	1
4	Main circuit board	1
6	Cross recessed pan tapping screw	4
7	Rod	1
8*	Seat	1
9	Washer	1
10	Spring	1
12	Swivel	1
14	Trigger	1
18	Mandril	1
19	Screw	2
20	Screw	1

Part No.	Description	Q'ty
21	Cross recessed pan tapping screw	4
22	Battery cover components	1
23	Battery cover	1
25	Cam	1
26	O-ring	2
27	Cross recessed pan tapping screw	2
28	Washer flat	2
29	left cover	1
30	Flexible spout	1
31*	Filter	1
33	Screw	3

Part No.	Description	Q'ty
34	Meter holder	1
35	Body	1
36	Shaft	2
37	Magnetic rod	2
38*	O-ring	1
39	Suction tube	1
40	Shaft	2
41	Rubber protector	1
42	Screw	4
44	Screw	1
45	Spring	1
46	Battery	1

No spare parts available.

NOTE: This product should be disposed of according to all applicable local and national government environment regulations and guidelines!



lubemate 
by macnaught

Lubemate® is a practical, cost-effective range of equipment brought to you by the trusted team at Macnaught.

All Lubemate products are specially selected by our experienced technical team at Macnaught®, ensuring they meet our strict quality standards.



Macnaught Pty Ltd

41-49 Henderson St, Turrella NSW 2205. Australia

Ph: 1800 185 102 **Fax:** +61 2 9597 7773

Email: info@macnaught.com **Website:** macnaught.com