

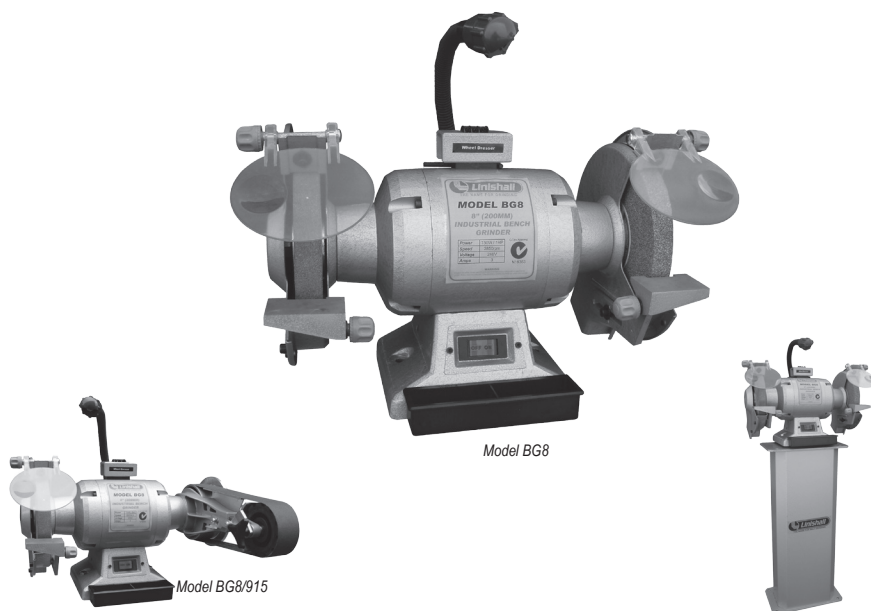

**THE NAME FOR GRINDING**

## **Instruction Manual Bench Grinding Series**

**Models BG6, BG8, BG8/915, BG10**



Model BG8

Model BG8/915

**Australia:**  
Garrick Herbert Pty Ltd  
460-462 The Boulevard  
Kirrawee, Sydney, NSW  
Ph: 02-9545 6633  
[www.linishall.com.au](http://www.linishall.com.au)

**New Zealand:**  
R.R. Bramley & Co Ltd  
184 Marua Rd  
Mt Wellington, Auckland  
Ph: 09-579 2036  
[www.bramley.co.nz](http://www.bramley.co.nz)

**USA:**  
Garrick USA LLC  
5455 West 6th St  
Winona, MN 55987  
Ph: 800-749 1064  
[www.linishall.com](http://www.linishall.com)

## Table of Contents

Safety Warnings .....3

The correct use & care of grinding wheels.....4

Model Specifications .....5

Unpacking & checking contents.....6

Assembly Instructions (Models BG6 & BG8).....8

Assembly Instructions (Model BG10 & BG8/915).....10

Genuine Parts and Accessories.....11

Warranty and Service.....12

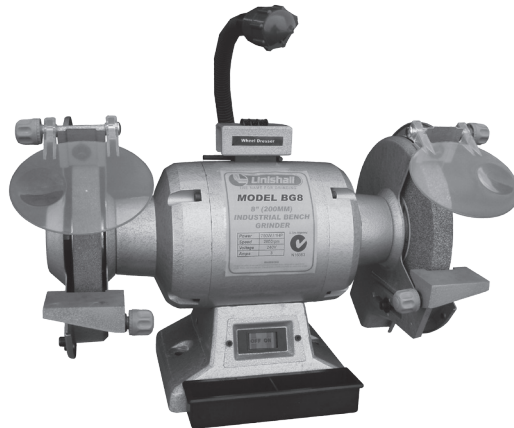

***This instruction manual should be read before assembling or using your bench grinder. All instructions should be strictly adhered to so the safety of yourself and others is protected. Keep this manual handy for future reference.***

- 1) The grinder and all accessories are designed and manufactured to be used only by persons trained in their proper use and only for their intended purpose. They are not intended for lengthy continuous usage. i.e. Turn ON, Sharpen Tool, Turn OFF
- 2) Follow assembly instructions closely and do not plug machine into mains power until all guards are firmly attached in the correct position (and remain so) and all parts are securely fitted.
- 3) Make sure the grinder is securely clamped or bolted to your workbench or pedestal stand and that the workbench or stand is securely attached to the floor.
- 4) Make sure the switch is in the *off* position before connecting to mains power. Any adjustments or maintenance should be made with the grinder unplugged from its power source. Ensure any keys or wrenches are removed.
- 5) Ensure the machine is electrically grounded. The plug must match the outlet and must never be modified in any way. Long extension leads should not be used due to voltage drop.
- 6) Ensure the work area is clean and well lit. Do not use in wet or damp conditions. Keep children and bystanders away.
- 7) Eye protection should always be used. Normal optical spectacles are not sufficient. Neck ties should be removed and sleeves rolled up. Long hair and loose clothing should be secured. Do not wear gloves. Non slip footwear or anti-slip footwear is recommended. Hearing protection should be used for prolonged use.
- 8) Never use the grinder if impaired by tiredness, alcohol, drugs or medication.
- 9) The action of grinding will produce dust and/or particles from both the material being ground and the grinding wheel or belt. Depending on the product being ground, these particles & dust may be harmful to your health. Ensure the area is well ventilated and that suitable dust mask or breathing apparatus is used.
- 10) Never leave a running grinder unattended. Do not leave the work area until it has come to a complete stop.
- 11) Your grinder should only ever be serviced by a qualified repair person. To ensure safety integrity, we recommend using only genuine **Linishall™** replacement parts or accessories.
- 12) Familiarise yourself with the section about correct use of grinding wheels

## The correct use & care of grinding wheels

Always use the correct type of grinding wheel according to the model of grinder and your intended use. Do not use grinding wheels as a cutting disc.

During normal use, grinding wheels will wear by becoming chipped, worn at the edges, grooved, out of balance and clogged by foreign material. This can be rectified by use of the wheel dresser fitted on the top of the grinder. Rest the cast face of the dresser on the tool rest and bring the wheels into contact with the wheel (whilst running). Move the dresser backwards & forwards (left and right) across the wheel until a fresh, flat, square face is exposed on the wheel.

Sometimes a wheel may be cracked. **Never under any circumstances use a cracked wheel for grinding as it could 'explode' causing serious injury to the operator.** Wheels can be tested for cracks with the "Ring Test". This involves hanging a wheel (removed from the grinder) by a piece of string passed through its centre hole. The wheel can then be tapped with a piece of scrap wood or similar and if OK the wheel will "ring". If there is a defect it will sound as a "thud". The defect may not be able to be detected by visual inspection. It is important that a wheel failing the ring test be permanently discarded.

The *Linishall™* grinders are supplied with general purpose grinding wheels. For specialised grinding applications, such as carbide grinding, please consult your local specialist abrasive distributor.

Always grind by using the outer diameter edge of the grinding wheel. Never grind on the side of the grinding wheel. This can cause the wheel to shatter.

Do not use excessive force on the grinding wheel. If it is not removing material fast enough, it is either clogged (requiring cleaning with the wheel dresser as above) or is not coarse enough. Choose the correct grit (coarseness) for the job.

Always adjust the tool rest as close as possible to the wheel (maximum 3mm gap) and do not attempt to grind objects that are too small to hold securely. Do not use the workpiece to slow down the wheel after turning the grinder off.

## MODEL SPECIFICATIONS

<b><i>Model BG6 Bench Grinder</i></b>		
Wheel Size (DxWxBore)	6"x $\frac{3}{4}$ "x $\frac{1}{2}$ " (150x19x12.7mm)	
Standard Wheel Grit	36 & 60	
Thread (Nut)	M12 x 1.75	
Motor	450W (0.6HP) Single Phase	
Voltage & Motor Speed	<b>Aust / NZ</b>	<b>USA</b>
	240v 50Hz 2,880rpm	120v 60Hz 3,450rpm
Lamp (Automotive type)	12v 6 watt	

<b><i>Model BG8 Bench Grinder</i></b>		
Wheel Size (DxWxBore)	8"x1"x $\frac{5}{8}$ " (200x25x16mm)	
Standard Wheel Grit	36 & 60	
Thread (Nut)	M16 x 2.0	
Motor	750W (1.0HP) Single Phase	
Voltage & Motor Speed	<b>Aust / NZ</b>	<b>USA</b>
	240v 50Hz 2,880rpm	120v 60Hz 3,450rpm
Lamp (Automotive type)	12v 6 watt	

<b><i>Model BG8/915 Bench, Belt &amp; Disc Grinder</i></b>	
Bench Grinder Specifications	As per BG8 Bench Grinder
Grinding Belt Size	36" x 2" (915 x 50 mm)
Grinding Disc Diameter	7" (178mm)

<b><i>Model BG10 Bench Grinder</i></b>		
Wheel Size (DxWxBore)	10"x1"x $\frac{3}{4}$ " (250x25x19mm)	
Standard Wheel Grit	36 & 60	
Thread (Nut)	M20 x 2.5	
Motor	900W (1.2HP) Single Phase	
Voltage & Motor Speed	<b>Aust / NZ</b>	<b>USA</b>
	240v 50Hz 2,880rpm	120v 60Hz 3,450rpm
Lamp (Automotive type)	12v 6 watt	

## Unpacking & checking of contents

Ensure carton is upright, carefully cut tape & open top flaps of carton. On models BG6, BG8 & BG8/915, some parts are located in recesses in the polystyrene packing showing. Remove these, check off against the list below, and set aside.

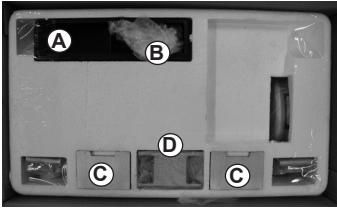

### Model BG6

- (A) 1 x Coolant Tray
- (B) 1 x hardware pack containing:
  - 2 x Toolrest Knob/Screw
  - 2 x Toolrest Flat Washer
  - 1 x Allen (Hex) Key
- (C) 2 x (1ea) LH & RH Toolrest
- (D) 1 x Wheel Dresser

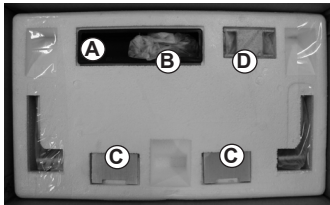

### Model BG8

- (A) 1 x Coolant Tray
- (B) 1 x hardware pack containing:
  - 2 x Toolrest Knob/Screw
  - 2 x Toolrest Flat Washer
  - 1 x Allen (Hex) Key
- (C) 2 x (1ea) LH & RH Toolrest
- (D) 1 x Wheel Dresser

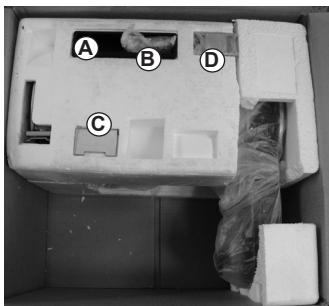

### Model BG8/915

- (A) 1 x Coolant Tray
- (B) 1 x hardware pack containing:
  - 1 x Toolrest Knob/Screw
  - 1 x Toolrest Flat Washer
  - 1 x Allen (Hex) Key
- (C) 1 x LH Toolrest
- (D) 1 x Wheel Dresser

For models **BG6 & BG8**, The whole carton should then be carefully turned upside down (with flaps open & out of the way) and then the carton can be lifted off the grinder in its polystyrene packaging.

Turn the package back up the correct way, carefully cut the packing tape along the join in the polystyrene packaging, and remove the top half of the polystyrene from the grinder.

Open the plastic bag and remove & set aside the eyeshield packs.

The grinder can then be lifted out of the plastic bag & the polystyrene packing and placed ready for assembly of loose components.

For model **BG8/915**, the top polystyrene packing can be removed, the eyeshield pack located & set aside, and then the grinder can be lifted out of the carton and made ready for final assembly.

Model **BG10** has polystyrene protection over the guards at each end. Remove the upper polystyrene from each end and then the grinder can be lifted out of the carton. (As the weight of the grinder is over 30Kg, it may require two people to safely lift it)

Locate the following items packed loosely in the carton and set aside for final assembly:

- 1 x LH Toolrest
- 1 x RH Toolrest
- 1 x Wheel Dresser
- 1 x Coolant Tray
- 2 x Eyeshield Packs
- 1 x hardware pack containing:
  - 4 x Hex Head Bolts M8x30
  - 4 x Flat Washers M8

**Your grinder is now ready for final assembly as per the instructions on Page 8.**

**Make sure it is placed securely on a firm workbench with adequate room to work freely & safely**

## ASSEMBLY OF THE GRINDER

### Models BG6 & BG8

1) The Wheel Dresser (A) clips into the plastic holder on top of the grinder. There is also a place at the rear of the plastic holder to store the allen (hex)key (B) which is used to adjust the toolrests.



2) Use the allen (hex) key to loosen the Left Hand toolrest arm (A), slide the arm forwards as far as it can go in its slot, and retighten loosely.

Position the toolrest (C) against the front of the toolrest arm as shown. There are radial grooves in both the toolrest & arm which should be matched up to achieve and lock the angle of the toolrest to the grinding wheel (Usually this is set so that the top of the toolrest is horizontal)

The toolrest knob/screw (B) can then be passed through the toolrest casting and screwed firmly into the arm.

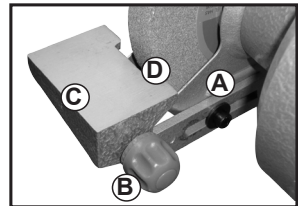

Loosen the toolrest arm again (A) and slide the assembly towards the grinding wheel until the gap (D) between the toolrest and the grinding wheel is no more than 3mm. Retighten the screw (A) firmly. Rotate the grinding wheel slowly by hand to ensure it can still run freely.

3) Repeat all steps in operation 2) for the Right Hand Toolrest assembly.



4) Adjust the Spark Guards at the top of each grinding wheel so that the gap between the spark guard & the wheel is no more than 2mm. Rotate the grinding wheel slowly by hand to ensure it can still run freely.

**Note:** As the wheels wear down, the spark guards must be adjusted to maintain the 2mm gap.



5) The eyeshields should then be fitted to the guards as shown in the picture.

Note the position of the three washers (A) which is important to allow the eyeshield to be adjusted without creating a wear point of the clear plastic against the sheetmetal of the guard.

The square section under the head of the bolt fits into the square hole of the eyeshield to lock the bolt when tightening the knob.

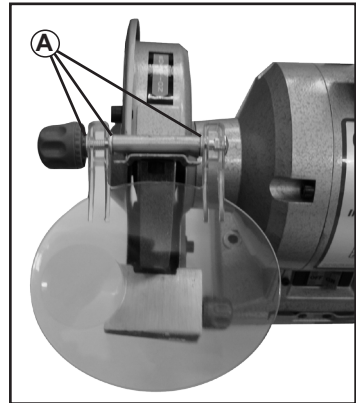

6) The coolant tray can then be fitted to its bracket on the base of the grinder, just under the switch.



7) The machine should then be securely bolted to a solid workbench or the optional pedestal stand. The workbench or stand must be securely attached to the floor.

8) The last operation before use is to adjust the worklight by its flexible stalk to a suitable position.



# ASSEMBLY OF THE GRINDER

## Model BG10

Many of the assembly instructions are the same as for BG6 & BG8 as listed on pages 8&9 and we will refer to them below

1) The Wheel Dresser clips into the plastic holder on top of the grinder as for BG6/BG8.

2) The toolrests are attached to the inside of the guards with the M8 Hex Head Bolts & Washers (A) as shown. The gap between the toolrest & grinding wheel must be adjusted as for BG6/BG8. Rotate the grinding wheel slowly by hand to ensure it can still run freely.

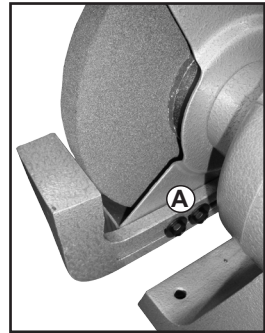

3) The eyeshields can be fitted by first unscrewing the bolt with spring washer & flat washer at position (A) on the inside guard.

The mounting bracket incorporates a Spark Guard (C) and should be adjusted to give the correct gap as per instruction 4) for BG6/BG8 on page 9.

Knob (B) can then be loosened to adjust the plastic eyeshield as shown and then retightened.

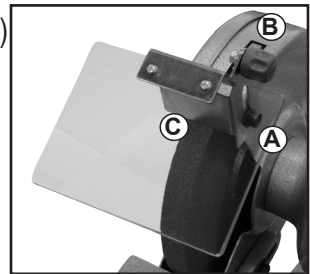

4) Then follow instructions 6), 7) & 8) on page 9 to fit the coolant tray and to secure the grinder on a suitable work surface.

## Model BG8/915

This model has a finishing attachment fully fitted to the right hand side of the grinder when supplied.

All other parts can be fitted to the grinder and left hand side as per the instructions for BG8 (pages 8+9)



# Genuine Parts & Accessories



### Grinding Wheels

In medium & fine grits to suit 150mm (6"), 200mm (8") & 250mm (10") bench grinders

### Wire Wheels

To suit 150mm (6"), 200mm (8") & 250mm (10") bench grinders



### Taper Spindles

To take polishing & buffing mops  
Models for BG8 Grinder (M16 thread) & BG10  
Grinder (M20 thread)  
Left Hand & Right Hand Models



### Buff or Polishing Guard

Suits most 200mm (8") Grinders  
Fits either RH or LH side  
Includes Dust extraction port  
*(Does not include taper spindle shown)*

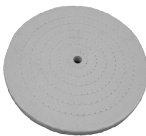
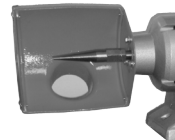

### Calico Mops for Buffing & Polishing

Used in conjunction with Taper Spindles  
on Bench Grinders.  
Sizes 200mm (8") & 250mm (10")

### Abrasive (Linishing) Belts

In sizes 915x50, 1220x50, 1520x50, 1520x100,  
2000x75, 2000x150, 2000x220 and various grits  
(coarse, medium, fine) to suit all the Linishall Belt  
Grinders



### Abrasive Disc

Suits 915 Belt & Disc Grinder  
178mm (7") diameter  
Coarse, Medium & Fine Grits  
Stick on or "Hook & Loop" types  
"Hook & Loop" conversion disc available



## 2 Year Warranty

LINISHALL Grinders are manufactured to our high quality standard. As such they are warranted against defect in material and workmanship for a period of 2 years from date of purchase. (This warranty does not apply to consumable items such as grinding wheels, wheel dressers, abrasive belts & discs or rubber contact wheels) We do not cover defects caused by misuse, abuse, product modification, lack of maintenance or repair by an unauthorised agent.

The warranty covers repair or replacement (at our sole discretion) of parts and labour, but does not include freight to or from our designated repair centres or the place of original purchase. This warranty covers only the initial purchaser of the grinder.

Warranty claims must be accompanied by documented proof of original purchase and an explanation of the problem causing the claim to be made.

Normal **service and genuine replacement parts & accessories** can be obtained via your original place of purchase or by contacting one of our offices as listed below for details of your nearest authorised service agent.



*Grinders manufactured in China to our specification.*

*Linishing attachments manufactured by us in Australia & New Zealand.*

### **Australia:**

**Garrick Herbert Pty Ltd**  
460-462 The Boulevarde  
Kirrawee, Sydney, NSW  
Ph: 02-9545 6633  
[www.linishall.com.au](http://www.linishall.com.au)

### **New Zealand:**

**R.R. Bramley & Co Ltd**  
184 Marua Rd  
Mt Wellington, Auckland  
Ph: 09-579 2036  
[www.linishall.co.nz](http://www.linishall.co.nz)

### **USA:**

**Garrick USA LLC**  
5455 West 6th St  
Winona, MN 55987  
Ph: 800-749 1064  
[www.linishall.com](http://www.linishall.com)