

X series

ST

STICK • TIG Inverter

DC INVERTER MANUAL

ST141X
Inverter Welder

ST181X
Inverter Welder



BOSSWELD

WELD LIKE A BOSS

X series

Thank you for choosing a BOSSWELD ST 141X / ST 181X Inverter DC MMA Welder

In this manual you will find instructions on how to set up your welder along with general welding information safety information and helpful tips. We encourage you to go online to our website for more tips and troubleshooting as well as many welding resources.

The BOSSWELD ST 141X / ST 181X are the latest in IGBT MMA Stick Electrode Welder technology, this very lightweight welding machine, is easy to use, generating a very smooth and stable output, ideal for welding jobs around the home, farm, workshop or on site.

We truly hope you enjoy using your welder!

**S**

STICK

- Easiest process to learn
- Best choice for quick repairs
- Slower than MIG welding
- Forgiving in dirty/rusty environments
- Not recommended for thin sheet metal welding

METAL TYPES

Mild steel, stainless steel & cast iron

T

TIG

- Gives a better weld finish
- Accurate heat control
- Considered the most challenging process to learn
- Good way to weld thin material
- Argon gas is required

METAL TYPES

Mild steel, stainless steel

CONTENTS	PAGE
WARRANTY	4
BOX CONTENTS	5
WARNINGS	6
MACHINE CARE / SAFETY INSTRUCTIONS	7
WORK AREA SAFETY	8
MAINTENANCE & DISPOSAL	9
FRONT & REAR PANEL LAYOUT	10
STICK / MMA WELDING SETUP	11-12
GENERAL MMA WELDING	13-14
TIG WELDING SETUP	15-16
LIFT ARC START	17
TIG TORCH SPARES	18
GENERAL TIG WELDING	19-20
TROUBLE SHOOTING	21



WARRANTY

This warranty is in addition to the statutory warranty provided under Australian Consumer Law, but does not include damage resulting from transport, misuse, neglect or if the product has been tampered with. The product must be maintained as per this manual, and installed and used according to these instructions on an appropriate power supply. The product must be used in accordance with industry standards and acceptable practice.

Special note:

If this welder's duty cycle is exceeded the welder will enter "thermal overload" which will automatically stop the welding output in order to protect, both the user and the welder. You will know the welder has gone into thermal overload when the overload error indicator light is illuminated. The welder will then cool itself down, and once the overload error indicator light is no longer illuminated, welding can then re-commence. Please note. Exceeding the machine's duty cycle, cannot be considered grounds for warranty or return.

This warranty covers the materials used to manufacture the machine and the workmanship used to produce the item. This Warranty does not cover damage caused by:

1. Normal wear and tear due to usage
2. Misuse /abuse or Neglect of the item
3. Transport / handling breakages
4. Lack of maintenance, care and cleaning
5. Environmental factors, such as usage in temperatures exceeding 40 degrees, above 1000mt sea level, rain, water, excessive damp, cold or humid conditions.
6. Improper setup or installation
7. Use on Incorrect voltage or non authorised electrical connections and plugs
8. Use of non standard parts
9. Repair, case opening, tampering with, modifications to any part of the item by non authorised BOSSWELD repairers.

This warranty covers the machine only and does not include Torches, Leads, Earth Clamps, Electrode holders, Plasma Torches, Tig Torches and any of the parts on those items unless there is a manufacturing fault.

1. REGISTRATION

Purchasers are encouraged to register for warranty on our website. www.bossweld.com.au/warranty

2. TIME PERIOD - 3 Years (ST 141X) (ST 181X)

A warranty claim must be made within 3 years from the date of purchase of this product. Any claim must include proof of purchase.

3. HOW TO MAKE A CLAIM - NEED SOME HELP?

- Visit our website www.bossweld.com.au/troubleshooting for many helpful tips and guides to assist with the setup and usage of your new machine. Still stuck....?
- Call the BOSSWELD Helpdesk on 1300 899 710 for over the phone assistance.
- If the machine is not operational then return the item to the place of purchase.

BOSSWELD MAKES NO OTHER WARRANTY, EXPRESS OR IMPLIED. THIS WARRANTY IS EXCLUSIVE AND IN LIEU OF ALL OTHERS, INCLUDING, BUT NOT LIMITED TO ANY WARRANTY OF MERCHANTABILITY OR FITNESS FOR ANY PARTICULAR PURPOSE.

Note: Warranty will be void if 15Amp plug is ground down (ST 181X)



DO NOT GRIND YOUR PLUG
This will void any warranty on your machine

BOSSWELD ST 141X / ST 181X Inverter DC MMA Arc Welder Box Contents

1. BOSSWELD ST 141X or ST 181X Inverter DC MMA Arc Welder
2. Electrode Holder Lead
3. Welding Earth Lead
4. Carry Strap
5. Owners Manual (not shown)





WARNING

The device and packaging material are not toys! Children must not be allowed to play with the machine and its accessories. Plastic parts and packaging are choking risks for children.

- Open the packaging and remove the welder carefully.
- Check that the delivery is complete.
- If possible, store the packaging until the warranty period has expired.

PERSONAL PROTECTIVE EQUIPMENT (PPE)



GLOVES AND PROTECTIVE CLOTHING

Use protective gloves and fire resistant protective clothing when welding. Avoid exposing skin to ultraviolet rays produced by the arc.



WELDING HELMET

Under no circumstances should the welder be operated unless the operator is wearing a welding helmet to protect the eyes and face. There is serious risk of eye damage if a helmet is not used. The sparks and metal projectiles can cause serious damage to the eyes and face. The light radiation produced by the arc can cause damage to eyesight, and burns to skin. Never remove the welding helmet whilst welding.



SAFETY GLASSES

After welding use appropriate safety glasses when brushing, chipping or grinding the slag from the weld.



OTHER PERSONS

Ensure that other persons are screened from the welding arc and are at least 15 metres away from the work piece. Always ensure that the welding arc is screened from onlookers, or people just passing by. Use screens if necessary, or non-reflecting welding curtain. Do not let children or animals have access to the welding equipment or to the work area.



SWITCHING OFF

When the operator has finished welding they must switch the welder off.

DO NOT put the electrode holder down with the welder switched ON.

When leaving the welder unattended, move the ON/OFF switch to the OFF position and disconnect the welder from the electrical mains supply.

Do not leave hot material unattended after welding.



FUMES & GASES ARE DANGEROUS

Smoke and gas generated whilst welding or cutting can be harmful to people's health. Welding produces fumes and gases. Breathing these fumes and gases can be hazardous to your health.

- Do not breathe the smoke and gas generated whilst welding or cutting, keep your head out of the fumes
- Keep the working area well ventilated, use fume extraction or ventilation to remove welding fumes and gases.
- In confined or heavy fume environments always wear an approved air-supplied respirator. Welding fumes and gases can displace air and lower the oxygen level causing injury or death. Be sure the breathing air is safe.
- Do not weld in locations near de-greasing, cleaning, or spraying operations. The heat and rays of the arc can react with vapours to form highly toxic and irritating gases.
- Materials such as galvanized, lead, or cadmium plated steel, containing elements that can give off toxic fumes when welded. Do not weld these materials unless the area is very well ventilated, and or wearing an air supplied respirator.



MACHINE CARE / SAFETY

Keep the welding cables, earth clamp and electrode holder in good condition. Failure to do this can result in poor welding quality, which could be dangerous in structural situations.

Prior to use, check for breakage of parts and any other conditions that may affect operation of the welder.

Any part of the welder that is damaged should be carefully checked to determine whether it will perform its intended function whilst being safe for the operator. Any part that is damaged should be properly repaired, or replaced by an authorised service centre.

IMPROPER USE

It is hazardous to use the welding machine for any work other than that for which it was designed e.g. do not use welder for thawing pipes.

HANDLING

Ensure the handle is correctly fitted. As welding machines can be heavy, always use safe lifting practices when lifting.

POSITION AND HANDLING

To reduce risk of the machine being unstable / danger of overturning, position the welding machine on a horizontal surface that is able to support the machine weight. Operators **MUST NOT BE ALLOWED** to weld in raised positions unless safety platforms are used.



SAFETY INSTRUCTIONS

WARNING

The user of this welder is responsible for their own safety and the safety of others. It is important to read, understand and respect the contents of this user guide. When using this welder, basic safety precautions, including those in the following sections must be followed to reduce the risk of fire, electric shock and personal injury. Ensure that you have read and understood all of these instructions before using this welder.

Persons who are not familiar with this user guide should not use this welder. Keep this booklet in a safe place for future reference.

TRAINING

The operator should be properly trained to use the welding machine safely and should be informed about the risks relating to arc welding procedures. This user guide does not attempt to cover welding technique. Training should be sought from qualified / experienced personnel on this aspect, especially for any welds requiring a high level of integrity for safety.





SERIOUS FIRE RISK

The welding process produces sparks, droplets of fused metal, metal projectiles and fumes.

This constitutes a serious fire risk. Ensure that the area in which welding will be undertaken is clear of all inflammable materials. It is also advisable to have a fire extinguisher, and a welding blanket on hand to protect work surfaces.



WORK AREA

-  Ensure a clear, well lit work area with unrestricted movement for the operator.
-  The work area should be well ventilated, as welding emits fumes which can be dangerous.
-  Always maintain easy access to the ON/OFF switch of the welder, and the electrical mains supply.
-  Do not expose the welder to rain and do not operate in damp or wet locations

Where welding must be undertaken in environments with increased risk of electric shock, confined spaces or in the presence of flammable or explosive materials, it is important that the environment be evaluated in advance by an “expert supervisor”. It is also recommended that welding in these circumstances be carried out in the presence of persons trained to intervene in emergencies.

AVOID ELECTRICAL CONTACT

Use adequate electrical insulation with regard to the electrode, the work piece and any accessible earthed metal parts in the vicinity. Avoid direct contact with the welding circuit. The no load voltage between the earth clamp and the electrode can be dangerous under certain circumstances.

Note: For additional protection from electric shock. It is recommended that this welder be used in conjunction with a residual current device (RCD) with rated residual current of 30MA or less.

In general the use of extension leads should be avoided. If used however, ensure that the extension lead is used with the welder is of a suitable current rating and heavy duty in nature that **MUST** have an earth connection. If using the welder outdoors, ensure that the extension lead is suitable for outdoor use. Always keep extension leads away from the welding zone, moisture and any hot materials.

WELDING SURFACES

Do not weld containers or pipes that hold, or have held, flammable liquids or combustible gases or pressure. Do not weld on coated, painted or varnished surfaces as the coatings may ignite, or can give off dangerous fumes.

WORK PIECE

When welding, the work piece will remain at high temperature for a relatively long period. The operator must not touch the weld or the work piece unless wearing welding gloves. Always use pliers or tongs. Never touch the welded material with bare hands until it has completely cooled.

VOLTAGE BETWEEN ELECTRODE HOLDERS OR TORCHES

Working with more than one welding machine on a single work piece, or on work pieces that are connected, may generate a dangerous accumulation of no-load voltage between two different electrode holders or torches, the value of which may reach double the allowed limit.



MAINTENANCE

WARNING

Before starting any cleaning, or maintenance procedures on the welding machine, make sure that it is switched OFF and disconnected from the mains supply.

There are no user serviceable parts inside the welder. Refer to a qualified service personnel if any internal maintenance is required. After use, wipe the welder down with a clean soft dry cloth.

Regular inspection of the supply cord is required and if damaged is suspected, it must be immediately replaced by the manufacturer, its service agent or similarly qualified persons in order to avoid a hazard

STORAGE/ TRANSPORT

Store the welder and accessories out of children's reach in a dry place. If possible store the welder in the original packaging. The appliance must unconditionally be secured against falling or rolling over during transport.



DISPOSAL

DISPOSING OF THE PACKAGING

Recycling packaging reduces the need for landfill and raw materials. Reuse of the recycled material decreases pollution in the environment. Please recycle packaging where facilities exist. Check with your local council authority for recycling advice.

DISPOSING OF THE WELDER

Welders that are no longer usable should not be disposed of with household waste but in an environmentally friendly way. Please recycle where facilities exist. Check with your local council authority for recycling advice.

FRONT PANEL

1. Power Indicator Light
2. Overload Error Indicator
3. Digital Display
4. MMA / TIG switch
5. Current Adjustment Knob
6. Positive Output Connection Socket
7. Negative Output Connection Socket

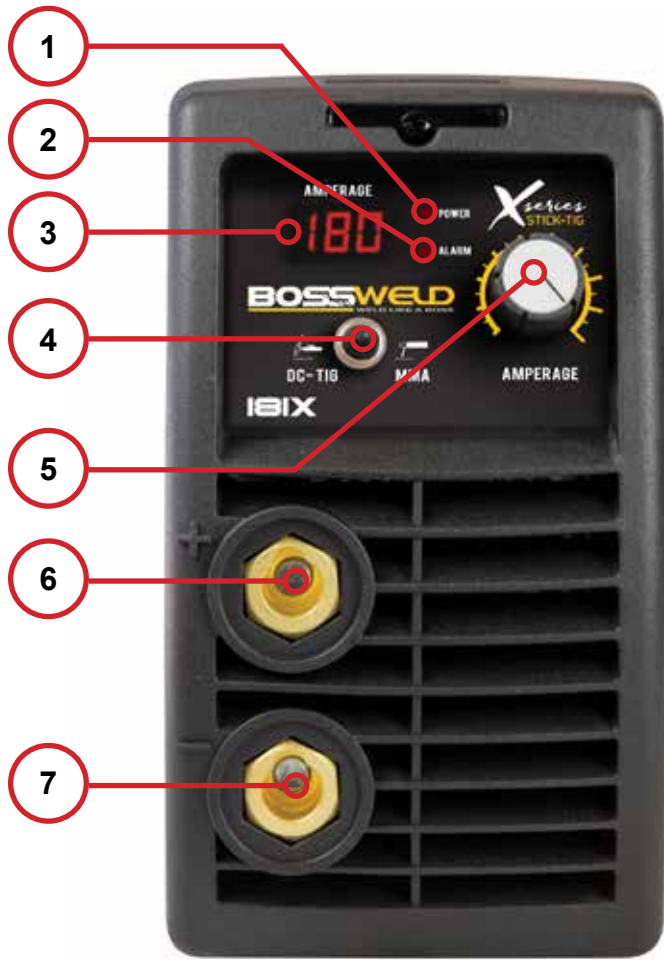

REAR PANEL

8. Mains Power Switch 10Amp - ST 141X
Mains Power Switch 15Amp - ST 181X
9. Cooling Fan
10. 240V AC Mains Power Cord

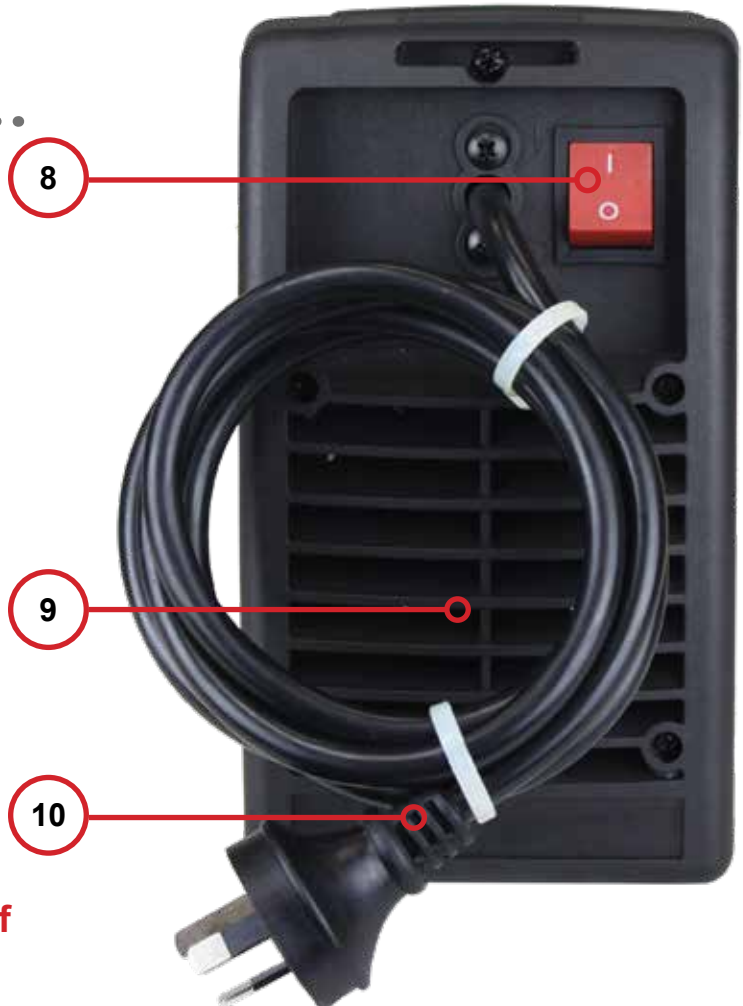

Note: Warranty will be void if 15Amp plug is ground down

MACHINE SET UP STICK / MMA

Note: The below image shows setup for DCEP / Negative Polarity
(Most Common application)

2. Connect Electrode holder to the **+** terminal

2. Connect earth Clamp to the **-** terminal



1 Plug the machine 10Amp (EVO 141) or 15Amp (ST 181X) input power lead into the wall socket, ensuring that the power switch on the machine is in the OFF position.



3 Connect earth clamp firmly to work-piece ensuring that the clamp makes good contact with bare metal.



2 Assemble Arc and Earth leads into the welding terminals depending on requirements of electrodes. Refer to your electrode packet for polarity and current requirements.

- DCEP/ Negative Polarity (most common application)
 - Earth clamp connector into the negative terminal.
 - Electrode holder connector into the positive terminal.

- DCEN/Straight Polarity
 - Earth clamp connector into the Positive terminal.
 - Electrode holder connector into the Negative terminal.

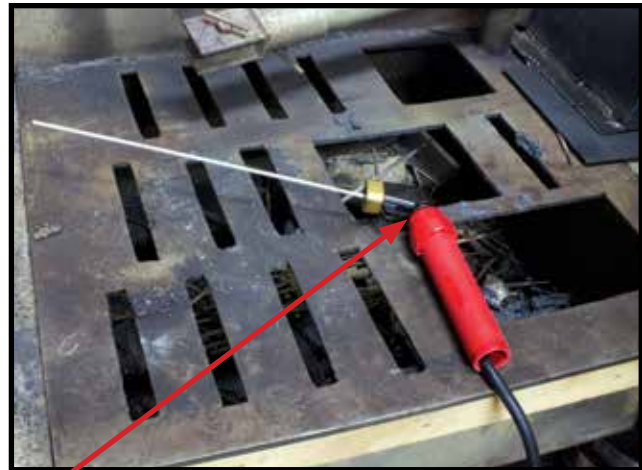

4 Take electrode holder and insert bare metal rod end of electrode and twist red handle to clamp electrode.

Note: Pictures may vary from your machine model



5 Ensure the electrode/electrode holder is not near the work-piece or can earth out, turn the machine on using the mains power switch. The front displays will light up and the cooling fan will start.



6 Select your required current by turning the Welding Parameter Adjustment Knob.

Average Metal Thickness	Electrode Size
1.0 - 2.0mm	2.0mm
2.0 - 5.0mm	2.6mm
5.0 - 8mm	3.2mm
8.0mm +	4.0mm

Amperage Selection Guide	
Rod Size/ Gauge	Welding Current
1.6mm	40-50 Amps
2.0mm	50-75 Amps
2.5mm	75-105 Amps
3.2mm	105-140 Amps
4.0mm	140-160 Amps

7 Please see table on page 13 as a guide to Welding Parameters.

STARTING THE ARC (SCRATCH)

The welding arc is obtained when the welding current is forced across a gap between the electrode tip and the workpiece. A welder must be able to strike and establish the correct arc easily and quickly.

The scratching method is easier for beginners. The electrode is moved across the plate inclined at an angle, as you would strike a match. As the electrode scratches the plate an arc is struck. When the arc has formed, withdraw the electrode momentarily to form an excessively long arc, then return to optimal arc length. The optimal arc length, or distance between electrode and puddle, is the same as the diameter of the electrode (the actual metal part within the flux covering). Holding the electrode too closely to the joint decreases welding voltage, which creates an erratic arc that may extinguish itself.

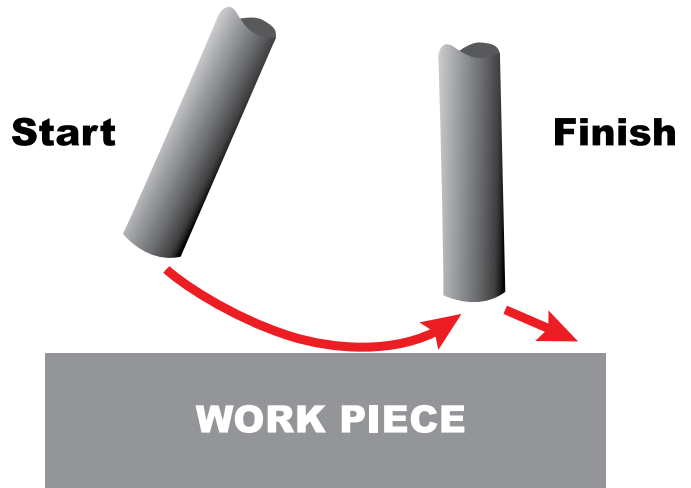

TIPS

- Keep the welding current as low as possible for the job at hand to maintain the best duty cycle from your welding machine, prevent the flux from burning and make slag removal easier.
- To break the circuit withdraw the electrode from the work piece. Be careful with the end of the electrode, as it will be HOT. Provided the current setting is correct, the surface of the work piece will also melt by the intensity of the electric arc. A degree of “penetration” is thereby obtained, and a complete “fusion” of the work piece and the deposited electrode is met.
- If the transformer overheats, the overload cut-out protector will activate and cut off. The light will illuminate to show that the cut out has operated.
- After cooling, the protector will reconnect the supply circuit and the welder will be ready for further use.

Note: If the duty cycle of the machine is exceeded, the thermostatic protection will activate and the machine will cut out, to cool down.

ELECTRODE SIZE SELECTION

Electrode size selection will be determined by the thickness of the section being welded. A thicker section will need a larger diameter electrode. The table below shows the maximum size of electrodes for average thicknesses of section (based on General Purpose 6013 Electrode).

Average Metal Thickness	Electrode Size
1.0 - 2.0mm	2.0mm
2.0 - 5.0mm	2.6mm
5.0 - 8mm	3.2mm
8.0mm +	4.0mm

WELDING CURRENT

Welding current level is determined by the size of electrode - the normal operating range and current are recommended by manufacturers. Typical operating ranges for a selection of electrode sizes are illustrated in the table. As a rule of thumb when selecting a suitable current level, an electrode will require about 40 Amps per millimetre (diameter). Therefore, the preferred current level for a 4mm diameter electrode would be 160 Amps, but the acceptable operating range is 140 to 180 Amps. It is important to match the machine to the job

Amperage Selection Guide	
Rod Size/ Gauge	Welding Current
1.6mm	40-50 Amps
2.0mm	50-75 Amps
2.5mm	75-105 Amps
3.2mm	105-140 Amps
4.0mm	140-160 Amps

MANUAL METAL ARC PROCESS (MMA WELDING)

When an arc is struck between the metal rod (electrode) and the workpiece, both the rod and workpiece surface melt to form a weld pool. Simultaneous melting of the flux coating on the rod will form gas and slag which protects the weld pool from the surrounding atmosphere. The slag will solidify and cool and must be chipped off the weld bead once the weld run is complete (or before the next weld pass is deposited). The process allows only short lengths of weld to be produced before a new electrode needs to be inserted in the holder. Weld penetration is low and the quality of the weld deposit is highly dependent on the skill of the welder.

TYPES OF ELECTRODES

Arc stability, depth of penetration, metal deposition rate and positional capability are greatly influenced by the chemical composition of the flux coating on the electrode. There are many types of Electrodes, and these are generally matched to the base metal. For example if welding Mild Steel then select a Mild Steel (General Purpose Electrode). Electrodes are identified by a universal numbering system (AWS Type code).

Base Metal	Electrode Type	Type
Mild Steel	Mild Steel General Purpose	6013
Stainless Steel	Stainless Steel 316L	316L
Dissimilar Metals	Dissimilar 680	312
Cast Iron	Nickel Arc 98	Ni99
High Strength Steel	Low Hydrogen	TC16

Electrodes are often packed in sealed packaging to keep moisture out. However, if a pack has been opened or damaged, it is essential that the electrodes are redried according to the manufacturer's instructions.

ARC FORCE

Also called Dig and Arc Control. Gives a power source variable additional amperage during low voltage (short arc length) conditions while welding. Helps avoid "sticking" stick electrodes when a short arc length is used.

POWER SOURCE

Electrodes can be operated with AC and DC power supplies. Not all DC electrodes can be operated on AC power sources; however AC electrodes may be used on either AC or DC

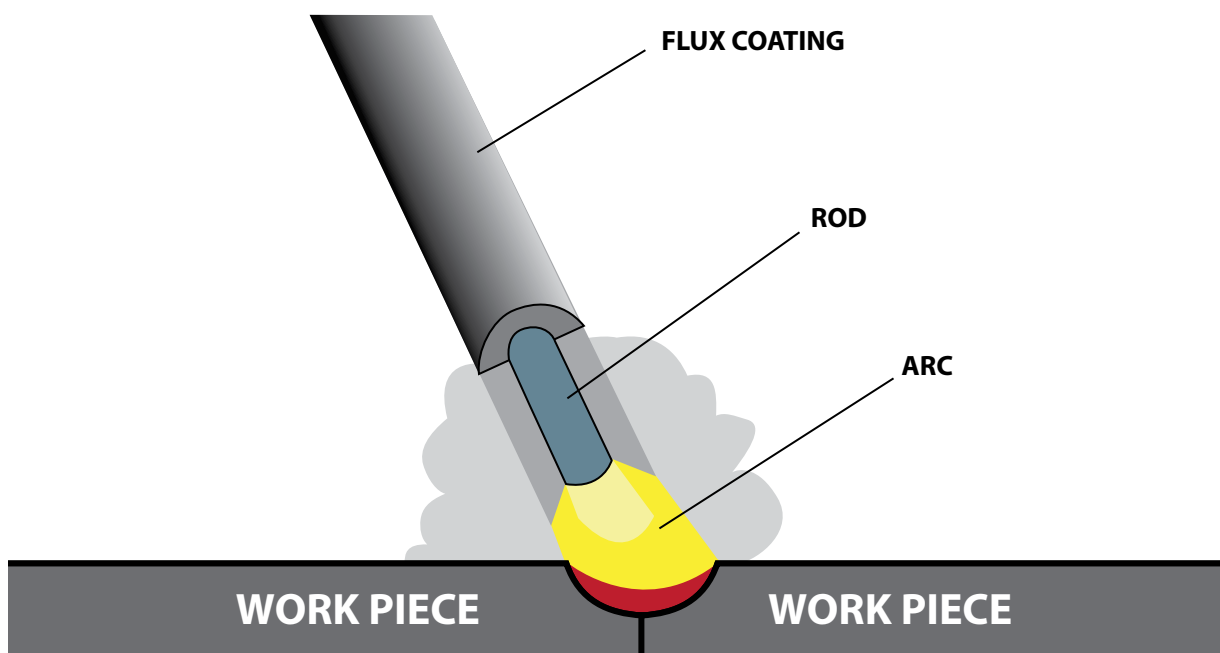

MACHINE SET UP TIG WELD

4. Connect the Argon Gas Regulator to the Gas bottle and connect the Gas Hose from the torch to the Input socket on the Regulator. Ensure the Gas regulator is in the off position.

2. Connect TIG Torch to the  terminal

7. Select TIG



NOTE: TIG Torch option and regulator shown are not supplied with the machine.



1. Plug the machine 10Amp (EVO 141) or 15Amp (ST 181X) input power lead into the wall socket, ensuring that the power switch on the machine is in the OFF position.

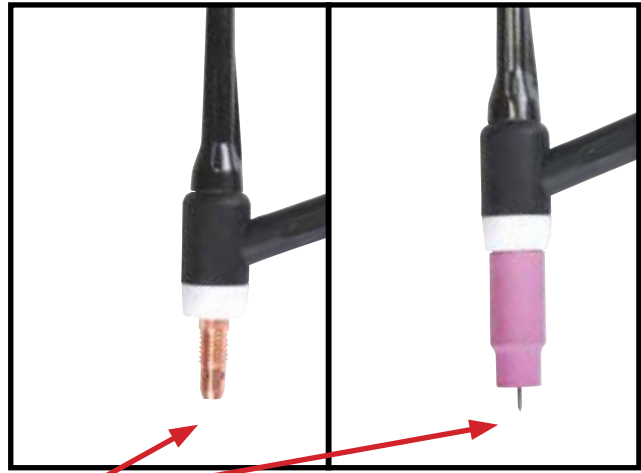

3. Set up the TIG torch. Place the Tungsten Electrode into the torch head and ensure back cap and collet body are screwed in firmly.

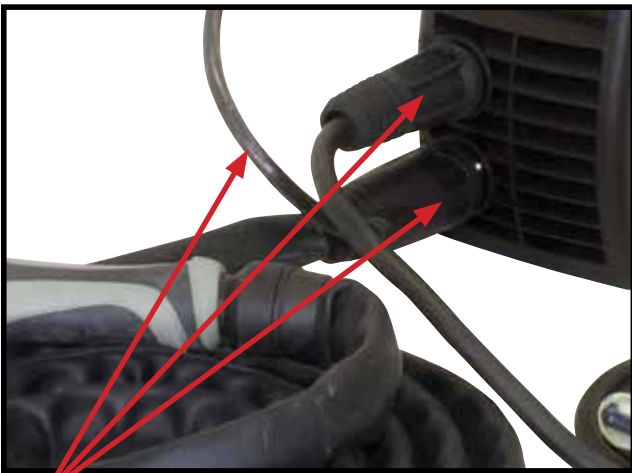

2. Install the TIG Torch to the machine by connecting the Dinse Connector to the Negative Output Connection Socket, the Gas hose to the regulator and the TIG Torch Control Socket and screw the nut up firmly.

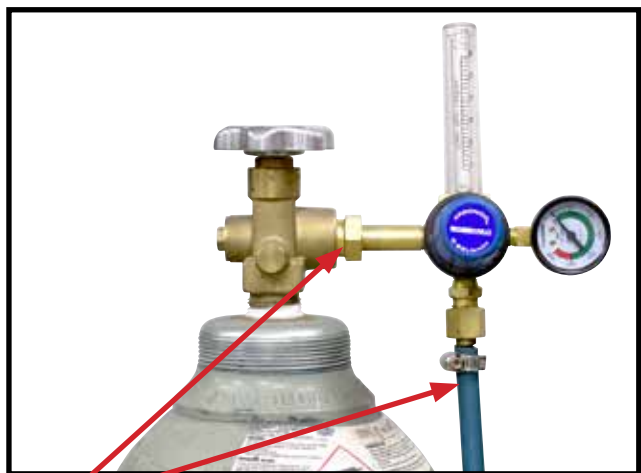

4. Connect the Argon Gas Regulator to the Gas bottle and connect the Gas Hose to the Gas Input socket from the torch to the Regulator. Ensure the Gas regulator is in the off position.

Note: Pictures may vary from your machine model

MACHINE SET UP TIG WELD - CONTINUED



5 Connect earth clamp to the positive terminal and firmly to work-piece ensuring that the clamp makes good contact with bare metal.

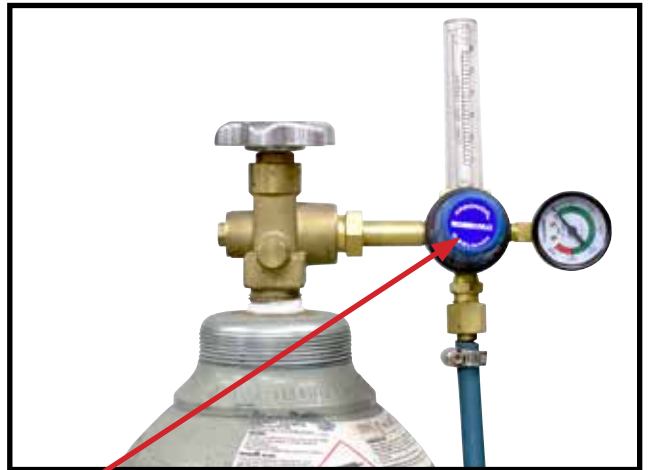

8 Turn on regulator and set gas flow to between 10-15 L/min depending on your welding environment.



6 Turn the machine on using the mains power switch. The front displays will light up and the cooling fan will start.



9 Turn the valve on the torch head to start the flow of gas, Remember to turn it off when finished welding.



7 Select DC-TIG, Select your required current by turning the Welding Parameter Adjustment Knob.

Note: It is advisable to run a few test welds using scrap or offcut materials, in order to tune the machine to the correct settings prior to welding the job.

IMPORTANT! -

We strongly recommend that you check for gas leakage prior to operation of your machine. We recommend that you close the cylinder valve when the machine is not in use. BOSSWELD authorised representatives or agents of BOSSWELD will not be liable or responsible for the loss of any gas.

LIFT ARC START

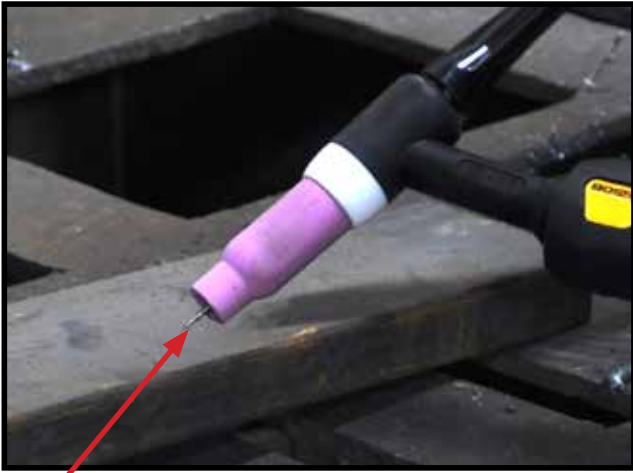

- 1 Lay the outside edge of the Gas Cup on the work piece with the Tungsten Electrode 1- 2mm from the work piece.

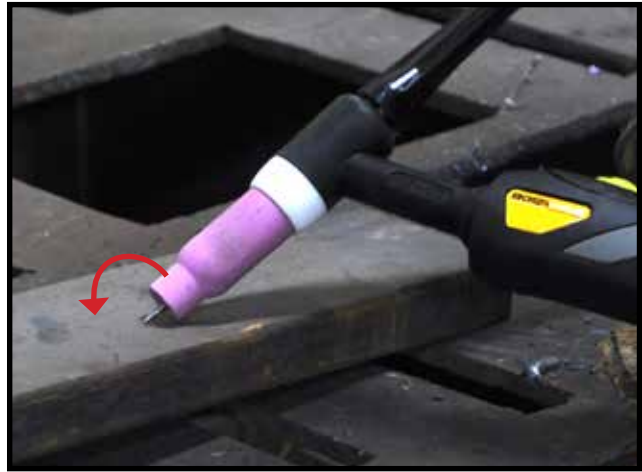

- 3 With a small movement rotate the Gas Cup forward so that the Tungsten Electrode touches the work piece.



- 2 Press the button on the TIG torch



- 4 Now rotate the Gas Cup in the reverse direction to lift the Tungsten electrode from the work piece to create the arc.

BOSSWELD 17 SERIES 150AMP TIG TORCH COMPLETE



PART NO.	DESCRIPTION
95.17FV.4.1.DA50	Tig Torch 17 Valve, 4mt, 1 pc, Dinse 50



PART NO.	DESCRIPTION
9957Y04	Back Cap Short
9957Y05	Back Cap Medium
995Y02	Back Cap Long



PART NO.	DESCRIPTION
9518CG	Torch Body Front Insulator
9554N01	Torch Body Front Insulator Lens Cup



PART NO.	DESCRIPTION
9510N21	Collet 0.5mm
9510N22	Collet 1.0mm
9510N23	Collet 1.6mm
9510N24	Collet 2.4mm
9510N25	Collet 3.2mm
9510N20	Collet 4.0mm



PART NO.	DESCRIPTION
9510N29	Collet Body 0.5mm
9510N30	Collet Body 1.0mm
9510N31	Collet Body 1.6mm
9510N32	Collet Body 2.4mm
9510N28	Collet Body 3.2mm
95406488	Collet Body 4.0mm



PART NO.	DESCRIPTION
9510N50	Alumin Cup Size 4
9510N49	Alumin Cup Size 5
9510N48	Alumin Cup Size 6
9510N47	Alumin Cup Size 7
9510N46	Alumin Cup Size 8
9510N45	Alumin Cup Size 10
9510N44	Alumin Cup Size 12



PART NO.	DESCRIPTION
954WP26V	Torch Head with Valve
95WP26FV	Flex Torch Head with Valve



PART NO.	DESCRIPTION
9545V24	Gas Lens Collet 1.0mm
9545V25	Gas Lens Collet 1.6mm
9545V26	Gas Lens Collet 2.4mm
9545V27	Gas Lens Collet 3.2mm
9545V28	Gas Lens Collet 4.0mm



PART NO.	DESCRIPTION
9554N18	Gas Len Alumin Cup Size 4 - 6.0mm
9554N17	Gas Len Alumin Cup Size 5 - 8.0mm
9554N16	Gas Len Alumin Cup Size 6 - 9.5mm
9554N15	Gas Len Alumin Cup Size 7 - 11.0mm
9554N14	Gas Len Alumin Cup Size 8 - 12.7mm
9554N19	Gas Len Alumin Cup Size 11 - 17.5mm

TUNGSTEN SELECTION / PREPARATION & GRINDING

ELECTRODES

Electrodes for DC welding are normally pure tungsten with 1 to 4% thoria to improve arc ignition. Alternative additives are lanthanum oxide and cerium oxide which are claimed to give superior performance (arc starting and lower electrode consumption). It is important to select the correct electrode diameter and tip angle for the level of welding current. As a rule, the lower the current the smaller the electrode diameter and tip angle. In AC welding, as the electrode will be operating at a much higher temperature, tungsten with a zirconia addition is used to reduce electrode erosion. It should be noted that because of the large amount of heat generated at the electrode, it is difficult to maintain a pointed tip and the end of the electrode assumes a spherical or 'ball' profile.

Grinding creates the greatest hazard as the exposed tungsten/thoria area is greatly increased and fine particles of potentially radioactive dust are released into the atmosphere. It is recommended that a dedicated grindstone with local dust extraction is used, and a simple filter mask is worn. If the grinding wheel is not fitted with a protective viewing screen, eye protection must be worn.

CORRECT PREPERATION - STABLE ARC

INCORRECT PREPERATION - STABLE ARC

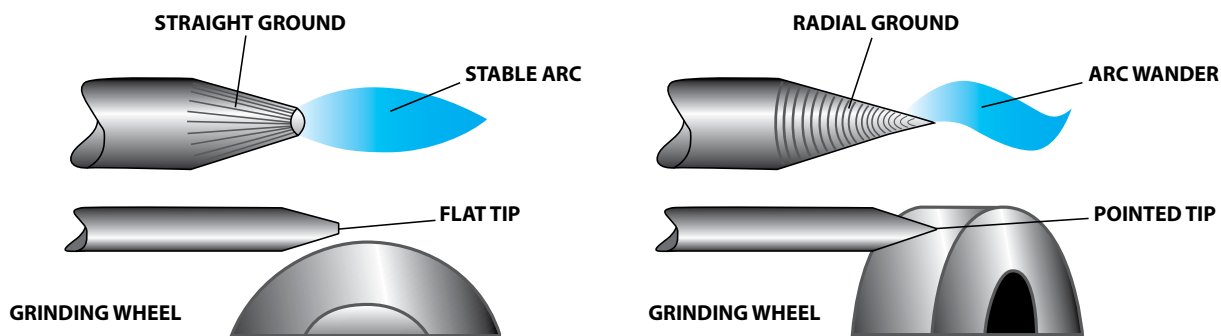

Note: Do not use wheel for other jobs or tungsten can become contaminated and cause lower weld quality

TIG WELDING

Tungsten inert gas (TIG) welding became an overnight success in the 1940s for joining magnesium and aluminium. Using an inert gas shield instead of a slag to protect the weldpool, the process was a highly attractive replacement for gas and manual metal arc welding. TIG has played a major role in the acceptance of aluminium for high quality welding and structural applications.

PROCESS CHARACTERISTICS

In the TIG process the arc is formed between a pointed tungsten electrode and the workpiece in an inert atmosphere of argon or helium. The small intense arc provided by the pointed electrode is ideal for high quality and precision welding. Because the electrode is not consumed during welding, the welder does not have to balance the heat input from the arc as the metal is deposited from the melting electrode. When filler metal is required, it must be added separately to the weldpool.

POWER SOURCE

TIG must be operated with a constant current power source - either DC or AC. A constant current power source is essential to avoid excessively high currents being drawn when the electrode is short-circuited onto the workpiece surface. This could happen either deliberately during arc starting or inadvertently during welding. If, as in MIG welding, a flat characteristic power source is used, any contact with the workpiece surface would damage the electrode tip or fuse the electrode to the workpiece surface. In DC, because arc heat is distributed approximately one-third at the cathode (negative) and two-thirds at the anode (positive), the electrode is always negative polarity to prevent overheating and melting. However, the alternative power source connection of DC electrode positive polarity has the advantage in that when the cathode is on the workpiece, the surface is cleaned of oxide contamination. For this reason, AC is used when welding materials with a tenacious surface oxide film, such as aluminium.

ARC STARTING

The welding arc can be started by scratching the surface, forming a short-circuit. It is only when the short-circuit is broken that the main welding current will flow. However, there is a risk that the electrode may stick to the surface and cause a tungsten inclusion in the weld.

TIG WELDING - CONTINUED

This risk can be minimised using the 'lift arc' technique where the short-circuit is formed at a very low current level. The most common way of starting the TIG arc is to use HF (High Frequency). HF consists of high voltage sparks of several thousand volts which last for a few microseconds. The HF sparks will cause the electrode - workpiece gap to break down or ionise. Once an electron/ion cloud is formed, current can flow from the power source.

Note: As HF generates abnormally high electromagnetic emission (EM), welders should be aware that its use can cause interference especially in electronic equipment. As EM emission can be airborne, like radio waves, or transmitted along power cables, care must be taken to avoid interference with control systems and instruments in the vicinity of welding.

HF is also important in stabilising the AC arc; in AC, electrode polarity is reversed at a frequency of about 50 times per second, causing the arc to be extinguished at each polarity change. To ensure that the arc is reignited at each reversal of polarity, HF sparks are generated across the electrode/workpiece gap to coincide with the beginning of each half-cycle.

WELDING GAS SELECTION CHART GUIDE

 TIG TIG WELDING	 ARGON	 Ar-CO₂-O₂
	MILD STEEL	✓
STAINLESS STEEL	✓	✗
LOW ALLOY STEEL	✓	✗
ALUMINIUM	✓	✗

APPLICATIONS

TIG is applied in all industrial sectors but is especially suitable for high quality welding. In manual welding, the relatively small arc is ideal for thin sheet material or controlled penetration (in the root run of pipe welds). Because deposition rate can be quite low (using a separate filler rod) MMA or MIG may be preferable for thicker material and for fill passes in thick-wall pipe welds.

TIG is also widely applied in mechanised systems either autogenously or with filler wire. However, several 'off the shelf' systems are available for orbital welding of pipes, used in the manufacture of chemical plant or boilers. The systems require no manipulative skill, but the operator must be well trained. Because the welder has less control over arc and weldpool behaviour, careful attention must be paid to edge preparation (machined rather than hand-prepared), joint fit-up and control of welding parameters.

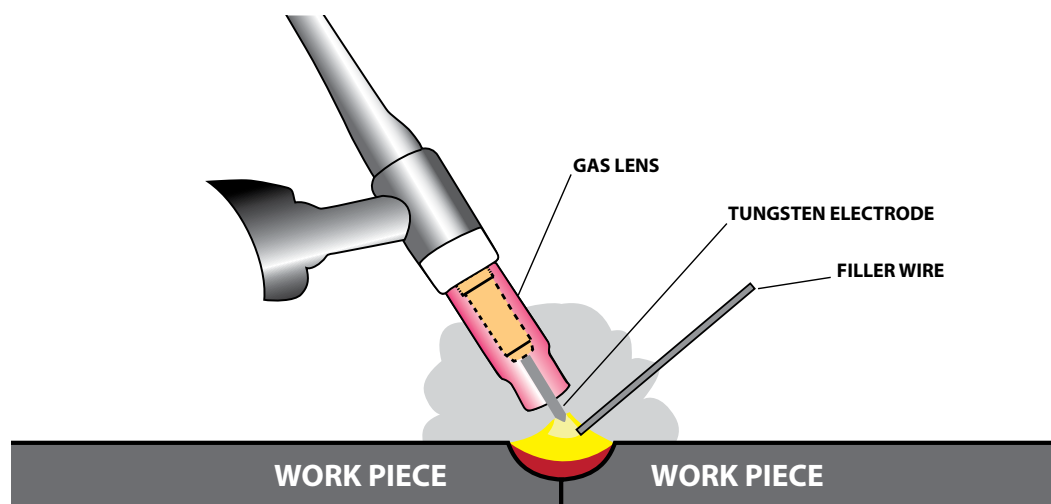

TROUBLE SHOOTING

Issue	Suggested Remedy
Power indicator is not lit, fan does not work and no output current	<ol style="list-style-type: none"> 1. Check that the welder is plugged into the 240V mains outlet and is switched on. 2. Check that the mains fuse or breaker has not operated. 3. Check that the main switch on the rear of the unit is in the on position.
Power indicator is lit, fan works, no output current	<ol style="list-style-type: none"> 1. Check the welding cables are connected correctly. 2. Check the output connectors are not disconnected or damaged. 3. Check that the earth clamp is connected securely to the work piece and that the contact point is clean of paint or rust.
Over temperature indicator is on, no output current	<ol style="list-style-type: none"> 1. Duty cycle of the unit has been exceeded. Allow the unit to cool for 20 minutes.
Output current is not stable.	<ol style="list-style-type: none"> 1. Check mains voltage is constant. 2. Check the welding cable connectors are tight in the sockets. 3. Check the earth clamp connection to the work piece. 4. Check the welding leads are not reversed.
Hot Welding Clamp	<ol style="list-style-type: none"> 1. Welding clamp rated current is too small, replace with larger size welding clamp.
Excessive Spatter	<ol style="list-style-type: none"> 1. Output polarity is incorrect, reverse output connector.

OPERATIONAL ENVIRONMENT

- Height above sea level ≤1000m
- Operation temperature range -10~+40°C
- Air relative humidity is below 90%(20°C)
- Preferably sit the machine above floor level, ensure the maximum angle does not exceed 15 degrees.
- Protect the machine against heavy rain and against direct sunshine.
- The content of dust, acid, corrosive gas in the surrounding air or substance must not exceed normal standard.
- Take care that there is sufficient ventilation during welding. There must be at least 30cm free distance between the machine and wall.

For other tips and troubleshooting refer to our website www.dynaweld.com.au/troubleshooting

MACHINE CONSUMABLE OPTIONS



Handy Pack Electrodes

Handy packs are the ideal solution for small welding jobs and repairs. Available in 4 diameter sizes including 1.6mm, 2.0mm, 2.6mm and 3.2mm. Handy packs ranges include General Purpose, Stainless Steel, Dissimilar Metals, Low Hydrogen and Cast Iron

CODE	DESCRIPTION
110160	680 Dissimilar x 2.6mm x (25 Pkt)
110170	680 Dissimilar x 3.2mm x (25 Pkt)
110190	Stainless Steel 316L-16 x 2.0mm x (25 Pkt)
110210	Stainless Steel 316L-16 x 2.6mm x (25 Pkt)
110230	Stainless Steel 316L-16 x 3.2mm x (25 Pkt)
110240	General Purpose 6013 x 1.6mm x (25 Pkt)
110250	General Purpose 6013 x 2.0mm x (25 Pkt)
110260	General Purpose 6013 x 2.6mm x (25 Pkt)
110270	General Purpose 6013 x 2.6mm x (50 Pkt)
110280	General Purpose 6013 x 3.2mm x (25 Pkt)
110290	General Purpose 6013 x 3.2mm x (50 Pkt)
110430	TC16 Electrode x 2.6mm x (25 Pkt)
110440	TC16 Electrode x 3.2mm x (25 Pkt)
110300	Nickel Arc 98 x 2.6mm x (25 Pkt)



CODE	DESCRIPTION
800041	Bossweld Anti Spatter Spray 500gr

Bossweld Anti Spatter Spray

This silicon free spatter release coating is a colourless film which stops weld spatter from sticking to welding equipment, work pieces & fixtures. Easily removed before painting or finishing.



CODE	DESCRIPTION
700010	Bossweld 16" Black & Gold Welding Glove

Bossweld 16inch Welding Gloves

Bossweld 16 inch welding gloves available in black and gold cow split leather.



CODE	DESCRIPTION
500086	Bossweld Professional Chipping Hammer 400 Grams

Bossweld Professional Chipping Hammer

Used for slag removal, and cleaning up weld beads post weld,

Features

- Comfortable hardened rubber handle
- Robust handle
- Hardened point and chisel for long life
- Trade quality



CODE	DESCRIPTION
500080	Bossweld 4 Row Engineer Wire Brush Wood Handle

Bossweld Wire Brush

Wooden handled wire brushes used for cleaning & preparation of metals pre & post welding.



CODE	DESCRIPTION
600311	Bossweld Welder Trolley Universal

Bossweld Universal Welders Trolley

Multi purpose welder trolley that suits most Bossweld welding machines.

Features

- 45kg capacity
- 3 storage levels
- Sturdy formed steel construction
- Cylinder holder accepts D and E size gas cylinders and comes with 2 safety chains
- Large 7.5cm casters for easy movement
- Welders sits at an angle for easy access to controls
- Handy cable hangers
- Overall dimension - 70.5cm (L) x 41.9cm (W) x 77.5cm (H)



CODE	DESCRIPTION
700015M	Bossweld "GoaTig" Tig Welding Glove - Medium

Bossweld Goat Skin Tig Glove

White goat skin TIG glove, reinforced tipping on back of 2nd and 3rd fingers, yellow cow split cuff, Kevlar stitching, unlined, (32cm for size M).

Features

- Reinforced tipping on the back of the 2nd and 3rd fingers
- Yellow cow split cuff
- Kevlar stitching
- Goat skin gloves
- Soft feel



CODE	DESCRIPTION
700001M	Bossweld Leather Welder's Jacket (Medium)
700001L	Bossweld Leather Welder's Jacket (Large)
700001XL	Bossweld Leather Welder's Jacket (X Large)
700001XXL	BossSafe Leather Welder's Jacket (XX Large)
700001XXXL	BossSafe Leather Welder's Jacket (XXX Large)

Bossweld Leather Welders Jacket

Leather welding jacket with metal snaps. Unlined, the jacket has heavy duty sewing.

Features

- Heavy duty chrome leather
- Double studs for extra protection
- Several sizes available
- Heavy duty sewing



CODE	DESCRIPTION
700120	1.0m x 2.0m Leather Welding Blanket
700123	1.8m x 1.8m Leather Welding Blanket
700121	2.0m x 2.0m Leather Welding Blanket
700122	3.0m x 3.0m Leather Welding Blanket

Bossweld Leather Welding Blanket

Chrome leather welding blanket. Ideally suited to covering items to protect against weld spatter. Commonly used in panel industry.

Features

- Heavy duty chrome leather blanket
- Excellent heat resistance
- Several sizes available
- For the protection around welding zones



OTHER PRODUCTS IN OUR RANGE

- ELECTRODES
- TIG RODS
- WELDING HELMETS
- WELDING MACHINES
- TORCH SPARE PARTS
- WELDING ACCESSORIES
- MIG WIRE
- GAS EQUIPMENT
- WELDING SAFETY
- MIG TORCHES
- TIG TORCHES
- WELDING CABLE

BOSSWELD
WELD LIKE A BOSS

series