

# Trade Catalogue

2014



**WHITE**  
INTERNATIONAL

# 2014 BRAND

## BENCH GRINDERS & ACCESSORIES

 **ABBOTT & ASHBY** 1

 **Multitool** 9

## CUTTING TOOLS

 **STAR-M** 13

 **MORRISON** 17

 **MENLO** 21

## FASTENING & ADHESIVES

 **Q-Bond** 25

**Fascor** 27

 **TACWISE** 31

## HAMMERS

 **Estwing** 35

 **THOR HAMMER** 43

**SANDO** 49

 **FALCON** 51

**TRAMONTINA** 55

## HAND TOOLS

 **STAHLWILLE** 59

**Koken** 129

 **SUPER** 189

**VBW**  195

# DIRECTORY

## HAND TOOLS cont.

 197

MAUN INDUSTRIES LTD  201

 205

 215

## MASONRY TOOLS

 **MARSHALLTOWN**  
The Premier Line 217

## MEASURING EQUIPMENT

 **trumeter**  
innovation by design 231

 **Avancer UK**  
www.avanceruk.com 235

 237

## PUMPS, POWER TOOLS & ACCESSORIES

 **triton**  
Precision Power Tools 239

 251

 **evolution**  
POWER TOOLS 281

 **TELWIN** 287

 **MAXUS**  
By CAMPBELL HAUSFELD 293

 **BIANCO  
PUMPZ** 295

 **Vacmaster**™ 307

 **PRYOR** 311

 **RÖHM** 323

## TOOL STORAGE

 **WHITE**  
INTERNATIONAL 327

Deliveries suspended under this Clause may at the option of the Company be cancelled without any liability attaching to the Company or completed within an extended period and in either case, the Company shall notify the Purchaser in writing accordingly.

## **7 TRANSPORT**

- 7.1 All deliveries,  
METRO and COUNTRY: FIS for all orders \$300.00 and over. Orders less than \$300, a \$30.00 processing fee applies.  
Western Australia - Country Orders: West Australian country orders will be supplied FIS to Perth, then shipped FOB to the destination.  
THIRD PARTY DELIVERIES: For third party deliveries, where a customer asks for the goods to be delivered to another location (e.g. to an end user), we will charge freight as per our freight matrix.
- 7.2 All deliveries to other destinations will be charged to the Purchaser
- (i) the Purchaser may nominate its own freight provider (subject to clause 7.3)
- (ii) the Purchaser may nominate White International to deliver the goods at a cost, which is in accordance with a schedule of rates provided.
- 7.3 Priority delivery service is available. All costs will be charged to the Purchaser.
- 7.4 Cost associated with offloading, unpacking, positioning, and erections are not included in the Company's selling price and are the responsibility of the Purchaser who shall provide competent labour to effect these arrangements at their own expense. Delivery of goods in all other cases shall be at the cost of the Purchaser.

## **8 RISK AND TITLE**

- 8.1 No general property or equitable interest in goods supplied by the Company to the Purchaser shall pass to the Purchaser until such time (hereinafter called "the specified time") as the price of the goods and all other moneys (if any) due from the Purchaser to the Company in respect of the goods or under any contract between the Company and the Purchaser shall have been paid to the Company in full.
- 8.2 Until the specified time the Purchaser shall be only a bailee of the goods for the Company and the Purchaser shall;
- (a) so hold the goods until the specified time as to enable them always readily to be identified as the property of the Company
- (b) upon written demand re-deliver the goods to the Company or allow the Company by its servants or agents to enter upon any premises where the goods are stored to recover the same.
- 8.3 The Purchaser is authorised before the specified time as agent for the Company to sell the goods for the account of the Company.
- 8.4 The goods shall be at the Purchaser's risk from the time of despatch from the Company's premises.
- 8.5 Where the seller holds any security interest in the goods, the Purchaser agrees to implement, maintain and comply in all material respects with procedures for the perfection of those security interests as provided by Personal Property Security Act 2009 (Cth).
- 8.6 The Purchaser must take all steps under Personal Property Security Act 2009 (Cth) to continuously perfect any such security interest, including all the steps necessary for the seller to obtain the highest ranking priority possible in respect of those security interests and to reduce as far as possible the risk of a third party acquiring and interest free of sellers security interests.

## **9 PAYMENT**

- 9.1 For machines ex Australian stock – payment 14 days from date of despatch ex company warehouse. For pumps and goods excluding machines ex Australian stock – payment on or before the 30th day of the month following the month in which the goods are despatched by the Company to the Purchaser (unless otherwise specified in the Company's statement/invoice).
- 9.2 For goods to be imported against order – 50% deposit with order, balance by irrevocable letter of credit to be established at the time of order through our nominated bank account payable on demand against presentation of documents unless otherwise arranged.
- 9.3 There shall be no delay of payment after delivery of the goods ordered except in accordance with the quoted terms.

## **10 CANCELLATION**

Request for cancellation of an order must be in writing. Any such cancellation shall be of no force or effect and shall not be binding on the Company unless and until such cancellation is accepted by the Company in writing. Cancellation of any order shall be at the sole and absolute discretion of the Company. No request for cancellation by the Purchaser will be accepted by the Company

where goods have been ordered from the Manufacturer by the Company against a firm order from the Purchaser.

## **11. SERVICE UNDER WARRANTY**

- 11.1 The performance figures quoted by the Manufacturer and/or the Company do not and shall not be deemed to constitute a warranty by the Company and it is not warranted that such exact performance figures will be achieved.
- 11.2 Inspection of a machine and its performance may be carried out by arrangement, at the Purchaser's expense.
- 11.3 The Manufacturer's normal working tolerances shall be considered correct for the machines unless otherwise specifically agreed between the Purchaser and the Company, in writing.
- 11.4 The Company shall by mutual arrangements with the Purchaser provide technical data assistance during run-off or commissioning of the machines or pumps but this does not include routine loading during extended test periods. Any commissioning period, if applicable, shall be for the duration of one (1) working day unless otherwise agreed to in writing.
- 11.5 Service given free of charge during the Manufacturer's warranty period does not include work properly described as maintenance and repair preventative maintenance must be provided by the Purchaser as recommended by the Manufacturer in order to preserve and fulfil the terms of warranty.
- 11.6 Extended commissioning shall be subject to the Company's then current rate of charges.
- 11.7 Where new components are purchased locally or supplied by the Company in order to expedite warranty service the faulty components must be retained by or returned to the Company freight prepaid to enable the Company to support its claim on the Manufacturer.

## **12. RETURN OF GOODS**

Save as herein provided, goods purchased from the Company shall in no case be returned to the Company unless;

- (i) the Purchaser first notifies the Company within 3 days of the receipt of goods, of its desire to return goods to the Company, stating the reasons therefor, and
- (ii) the Company agrees to accept the return of the goods, subject always to such terms and conditions (if any) as the Company shall in its absolute discretion stipulate, and
- (iii) the goods are returned freight prepaid to the Company at its head office warehouse.
- (iv) All goods returned will be subject to a handling charge of the greater of \$30 or 10% of the sale price of the goods. Any goods which are classified as being made to order or not listed on the Seller's current standard price list are not able to be returned.
- Goods returned to the Company shall at all relevant times be at the sole risk of the Purchaser. It shall be the Purchaser's obligation and responsibility to obtain a written acknowledgment from the Company as to its receipt of goods returned by the Purchaser to the Company pursuant to and in accordance with the terms of this clause.
- (v) The goods must be returned in their original packaging and be in an unused and saleable condition. Any repairs (inc repackaging) will be charged tot he purchaser in addition to the restocking fee.

## **13. DEFINITIONS**

In this agreement unless the context requires otherwise the following expressions shall have the following meanings respectively;

- (i) "Distributor" means the authorised distributor of the Company
- (ii) "Purchaser" means and includes the Distributor (where the context so admits) and the original retail purchaser of the goods (and whether purchased from the Distributor or from the Company direct).
- (iii) "Goods" means any goods purchased from the Company.
- (iv) "Contract" means all those documents comprising the agreed terms of sale of goods by the Company to the Purchaser including but not limited to purchase order, invoices, the Company's General Terms and Conditions of Sale and such other written material of the Manufacturer and/or the Company relating to the goods and which is issued to or brought to the notice of the Purchaser and any writing of the Purchaser issued to the Company or its Distributor and accepted by the Company as constituting a term or condition of the contract.
- (v) "Manufacturer" means the manufacturer of goods sold by the Company.
- (vi) "The Company" shall mean and include White International Pty Limited and any other related or associated companies.

## **14. PERSONAL INFORMATION**

Please refer to our website [www.whiteint.com.au](http://www.whiteint.com.au) to view our privacy policy.

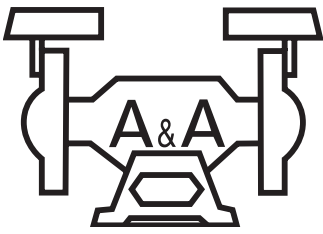











# ABBOTT & ASHBY

Proudly Australian Owned Abbott & Ashby are leaders in bench grinders and buffing machines.

Abbott & Ashby offer a broad range of accessories that when used with PA Multitool Add-Ons really maximise the use of your bench grinder. Whether for industrial or domestic use, the accessory products make the job faster, easier and help achieve the required quality finish.



PART NO.	ITEM	DESCRIPTION	BARCODE	IMAGE
<b>BENCH GRINDERS</b>				
ATBGU/6	500838	<b>BENCH GRINDER UTILITY 6"/150MM</b> Abbott & Ashby Utility 150mm Bench Grinder 280 watt - 240 volt 10 amp plug 150mm x 25mm wheels Includes safety eye shields & tool rests Capacitor start, powerful induction motor. Sealed for life bearings, vibration absorbing pads on base Weight 10.3kg	9313540302444	
ATBGU/8	500839	<b>BENCH GRINDER UTILITY 8"/200MM</b> Abbott & Ashby Utility 200mm Bench Grinder 375 watt - 240 volt 10 amp plug 200mm x 25mm wheels Includes safety eye shields & tool rests Capacitor start, powerful induction motor. Sealed for life bearings, vibration absorbing pads on base Weight 18kg	9313540302451	
ATBG280/6	500831	<b>BENCH GRINDER 150MM/6" 280W INDUSTRIAL</b> Abbott & Ashby Industrial 150mm Bench Grinder 280 watt - 240 volt 10 amp plug 150mm x 25mm wheels Includes heavy duty safety eye shields & heavy duty tool rests Capacitor start, powerful induction motor. Sealed for life bearings, vibration absorbing pads on base Weight 10.3kg	9313540300037	
ATBG600/8	500833	<b>BENCH GRINDER 200MM/8" 600W INDUSTRIAL</b> Abbott & Ashby Industrial 200mm Bench Grinder 600 watt - 240 volt 10 amp plug Full 3/4 HP PLUS, the most powerful bench grinder in its class. Fully adjustable tool rests. Features 50mm wide wheel guards to accept the use of wire wheels without fouling. 25mm wide wheels standard. Weight 23kg	9313540300068	
ATBG930/10	500836	<b>BENCH GRINDER 250MM/10" 1.25HP 240V</b> Abbott & Ashby Industrial 250mm Bench Grinder 930 watt 1.25 HP - 240 volt 15 amp plug Adjustable tool rests & Safety eye shields Features 50mm wide wheel guards to accept the use of wire wheels without fouling. 25mm wide wheels standard. Weight 45kg	9313540300150	
ATBG600/8WBM	500835	<b>BENCH GRINDER 200MM/8"-1WIRE WHEEL/1 GR WHEEL</b> Abbott & Ashby Industrial 200mm Bench Grinder with wire wheel 600 watt - 240 volt 10 amp plug Full 3/4 HP PLUS, the most powerful bench grinder in its class. Fully adjustable tool rests. Features 50mm wide wheel guards to accept the use of wire wheels without fouling. 25mm wide wheels standard. Included 1 x grinding wheel and 1 x wire wheel Weight 23kg	9313540300785	
<b>JEWELLER'S BUFFING MACHINE</b>				
Abbott & Ashby buffing machines dispense with grinding wheels, guards and tool rests, and are designed to take the appropriate accessories for buffing and finishing work, such as spindles (tapered or straight), wire wheels, mops etc				
ATBM280/6	500840	<b>BUFFING MACHINE (JEWELLERY) 0.37HP 150MM + SPINDLES</b> 280watt - 240 volt 10amp plug Supplied with precision made tapered jewellers spindles suitable for buffing or polishing using appropriate "mops"	9313540302475	

PART NO.	ITEM	DESCRIPTION	BARCODE	IMAGE
<b>ADD-ONS</b>				
ATTR8A	500884	ADJUSTABLE TOOL REST (RIGHT OR LEFT) Fits <b>BOTH</b> 6" & 8" Abbott & Ashby Bench Grinders	9313540302765	
ATES6	500855	EYE SHIELD FOR 6" BENCH GRINDER-PAIR Shatter resistant Perspex	9313540300099	
ATES8	500859	EYE SHIELD FOR 8" BENCH GRINDER-PAIR Shatter resistant Perspex	9313540300051	
ATSW6/8NEW	500876	ON/OFF SWITCH		
ATPED-HDK	500870	PEDESTAL HEAVY DUTY SUITS MOST BENCH GRINDERS Manufactured from heavy duty steel sections, the pedestal is designed to support both 150mm & 200mm bench grinders without taking up valuable bench space.	9313540300167	
ATCAP5MF	500848	CAPACITOR 5 MFD TO SUIT 6" GRINDER		
ATCAP13MF	500844	CAPACITOR 13 MFD TO SUIT 8" GRINDER		











## See Multitool Bench Grinder Accessories and Linishing Attachments Pages 12 - 14











PART NO.	ITEM	DESCRIPTION	BARCODE	IMAGE
<b>ABRASIVE BELTS</b>				
Abbott & Ashby's range of abrasive belts covers a wide range sizes for all types of Industrial Power Tools. Whether the job calls for Aluminium Oxide, Silicon Carbide or Scotchbrite® belts, you are sure to find one of the right size and grit within the range, if not, special orders are accepted and quoted on application.				
<b>Aluminium Oxide &amp; Surface Conditioning 25mm x 610mm - (Suits Portagrind)</b>				
AAA25/610-040	500014	ALOX BELT 25X610-40GR (PACK OF 10)	9313540300372	
AAA25/610-060	500015	ALOX BELT 25X610-60GR (PACK OF 10)	9313540300389	
AAA25/610-080	500016	ALOX BELT 25X610-80GR (PACK OF 10)	9313540300396	
AAA25/610-120	500018	ALOX BELT 25X610-120GR (PACK OF 10)	9313540300419	
AAA25/610-180	500019	ALOX BELT 25X610-180GR (PACK OF 10)	9313540300426	
<b>Aluminium Oxide &amp; Surface Conditioning 50mm x 915mm - (Suits PO362 Multitool)</b>				
AAA50/915-040	500032	ALOX BELT 50X915-40GR (PACK OF 10)	9313540300679	
AAA50/915-060	500033	ALOX BELT 50X915-60GR (PACK OF 10)	9313540300686	
AAA50/915-080	500034	ALOX BELT 50X915-80GR (PACK OF 10)	9313540300693	
AAA50/915-100	500035	ALOX BELT 50X915-100GR (PACK OF 10)	9313540300709	
AAA50/915-120	500036	ALOX BELT 50X915-120GR (PACK OF 10)	9313540300716	
AAA50/915-150	500037	ALOX BELT 50X915-150GR (PACK OF 10)	9313540300723	
AAA50/915-180	500038	ALOX BELT 50X915-180GR (PACK OF 10)	9313540300730	
AAA50/915-240	500039	ALOX BELT 50X915-240GR (PACK OF 10)	9313540300747	
AAA50/915-320	500040	ALOX BELT 50X915-320GR (PACK OF 10)	9313540300754	
AAA50/915-400	500041	ALOX BELT 50X915-400GR (PACK OF 10)	9313540300761	
AASCB50/915FP	500199	SURFACE CONDITIONING BELT 50x915F -CARDED	9313540300358	
AASCB50/915M	500200	SURFACE CONDITIONING BELT 50x915 MEDIUM		
AASCB50/915P	500201	POLISHING BELT 50x915F -CARDED	9313540301737	
<b>Aluminium Oxide &amp; Silicone Carbide Packs 50mm x 915mm - (Suits PO362 Multitool)</b>				
AAPACK50/915-40	500170	ALOX BELTS 40 GRIT-COARSE (PACK OF 3)	9313540302642	
AAPACK50/915-80	500173	ALOX BELTS 80 GRIT-MEDIUM (PACK OF 3)	9313540302659	
AAPACK50/915150	500168	ALOX BELTS 150 GRIT-FINE (PACK OF 3)	9313540302666	
AAPACK50/915240	500169	ALOX BELTS 240 GRIT-X FINE (PACK OF 3)	9313540302673	
AAPACK50/915400	500171	ALOX BELTS 400 GRIT-XX FINE (PACK OF 3)	9313540302680	
AAPACK50/915-5	500172	ALOX BELTS ASSORTED (PACK OF 5)	9313540300235	



PART NO.	ITEM	DESCRIPTION	BARCODE	IMAGE
AAPACKSCB	500175	ALOX BELTS SILICONE CARBIDE 120G (PACK 3)	9313540302697	
<b>Aluminium Oxide 50mm x 1220mm - (Suits PO482 &amp; PO8CW Multitool)</b>				
AAA50/1220-040	500021	ALOX BELT 50X1220-40GR (PACK OF 10)	9313540300457	
AAA50/1220-060	500022	ALOX BELT 50X1220-60GR (PACK OF 10)	9313540300464	
AAA50/1220-080	500023	ALOX BELT 50X1220-80GR (PACK OF 10)	9313540300471	
AAA50/1220-100	500024	ALOX BELT 50X1220-100GR (PACK OF 10)	9313540300488	
AAA50/1220-120	500025	ALOX BELT 50X1220-120GR (PACK OF 10)	9313540300495	
AAA50/1220-150	500026	ALOX BELT 50X1220-150GR (PACK OF 10)	9313540300501	
AAA50/1220-240	500027	ALOX BELT 50X1220-240GR (PACK OF 10)	9313540300525	
AAA50/1220-400	500028	ALOX BELT 50X1220-400GR (PACK OF 10)	9313540300532	
<b>Aluminium Oxide 100mm x 915mm - (Suits PO364 Multitool)</b>				
AAA100/915-040	500004	ALOX BELT 100X915-40GR (PACK OF 10)	9313540300174	
AAA100/915-060	500005	ALOX BELT 100X915-60GR (PACK OF 10)	9313540300181	
AAA100/915-080	500006	ALOX BELT 100X915-60GR (PACK OF 10)	9313540300198	
AAA100/915-100	500007	ALOX BELT 100X915-100GR (PACK OF 10)	9313540300204	
AAA100/915-120	500008	ALOX BELT 100X915-120GR (PACK OF 10)	9313540300211	
AAA100/915-150	500009	ALOX BELT 100X915-150GR (PACK OF 10)	9313540300228	
AAA100/915-180	500010	ALOX BELT 100X915-180GR (PACK OF 10)	9313540300242	
AAA100/915-240	500011	ALOX BELT 100X915-240GR (PACK OF 10)	9313540300259	
AAA100/915-320	500012	ALOX BELT 100X915-320GR (PACK OF 10)	9313540300266	
<b>Aluminium Oxide 100mm x 1220mm - (Suits PO484 Multitool)</b>				
AAA100/1220-040	500001	ALOX BELT 100X1220-40GR (PACK OF 10)	9313540300273	
AAA100/1220-060	500002	ALOX BELT 100X1220-60GR (PACK OF 10)	9313540300280	
AAA100/1220-080	500003	ALOX BELT 100X1220-80GR (PACK OF 10)	9313540300297	
<b>ABRASIVE DISCS - Self Adhesive</b>				
<b>Aluminium Oxide 175mm - (Suits PO362, PO364, PO482, PO484, PO8CW Multitools)</b>				
Abrasive disc for Multitool. Has self adhesive back for easy installation on to Multitool.				
AADSA175/040	500060	DISC ALOX 175MM SELF ADHESIVE-40G (5 PACK)	9313540300914	
AADSA175/060	500061	DISC ALOX 175MM SELF ADHESIVE-60G (5 PACK)	9313540300921	
AADSA175/080	500062	DISC ALOX 175MM SELF ADHESIVE-80G (5 PACK)	9313540300938	
AADSA175/100	500063	DISC ALOX 175MM SELF ADHESIVE-100G (5 PACK)	9313540300945	
AADSA175/120	500064	DISC ALOX 175MM SELF ADHESIVE-120G (5 PACK)	9313540300952	
AAPACKDSA175-4	500174	DISC ALOX 175MM ASSORTED (PACK OF 4)	9313540301003	

PART NO.	ITEM	DESCRIPTION	BARCODE	IMAGE
<b>ABRASIVE DISCS - Hook &amp; Loop</b>				
<b>Backing Pads</b>				
Hook loop self adhesive backing pad. Used for mounting abrasive disc with loop back on to sanding machine				
AABPV/150	500042	BACKING PAD 150MM HOOK & LOOP	9313540300792	
AABPV/175	500043	BACKING PAD 175MM HOOK & LOOP	9313540300808	
AABPV/225	500044	BACKING PAD 225MM HOOK & LOOP	9313540300815	
AABPV/300	500045	BACKING PAD 300MM HOOK & LOOP	9313540300822	
<b>Aluminium Oxide 175mm - (Suits PO362, PO364, PO482, PO484, PO8CW Multitools)</b>				
Abrasive disc for Multitool. Used in conjunction with self adhesive backing disc on Multitool. Ideal for quick removal and replacement.				
AADV175/040	500073	DISC ALOX 175MM HOOK/LOOP BACK 40G (5 PACK)	9313540301157	
AADV175/060	500074	DISC ALOX 175MM HOOK/LOOP BACK 60G (5 PACK)	9313540301164	
AADV175/080	500075	DISC ALOX 175MM HOOK/LOOP BACK 80G (5 PACK)	9313540301171	
AADV175/100	500076	DISC ALOX 175MM HOOK/LOOP BACK 100G (5 PACK)	9313540301188	
AADV175/120	500077	DISC ALOX 175MM HOOK/LOOP BACK 120G (5 PACK)	9313540301195	
<b>Aluminium Oxide 175mm Disc Packs - (Suits PO362, PO364, PO482, PO484, PO8CW Multitools)</b>				
Abrasive disc for Multitool. Used in conjunction with self adhesive backing disc on Multitool. Ideal for quick removal and replacement.				
AAPACKVEL175040	500176	DISC ALOX 175MM HOOK/LOOP 40G (4 PACK)	9313540302703	
AAPACKVEL175060	500177	DISC ALOX 175MM HOOK/LOOP 60G (4 PACK)	9313540302710	
AAPACKVEL175080	500178	DISC ALOX 175MM HOOK/LOOP 80G (4 PACK)	9313540302727	
AAPACKVEL175100	500179	DISC ALOX 175MM HOOK/LOOP 175G (4 PACK)	9313540302734	
AAPACKVEL175-5	500180	DISC ALOX 175MM HOOK/LOOP DISC/PAD PACK (5 PACK)	9313540301348	
<b>BUFFING COMPOUNDS - Suits Buffing Mops</b>				
<b>Blister Packed</b>				
AACOMGREENBL	500047	<b>BUFFING COMPOUND GREEN BLISTER PACK</b> For use with buffing/polishing mops. For a high gloss finish on copper, brass and stainless steel. In blister pack	9313540302505	
AACOMGREYBL	500049	<b>BUFFING COMPOUND GREY BLISTER PACK</b> For quick removal of deep marks, rust, pitting in steel etc. In blister pack	9313540302529	
AACOMREDBL	500051	<b>BUFFING COMPOUND RED BLISTER PACK</b> For use with buffing/polishing mops. General purpose for copper, brass, aluminium and stainless steel. In blister pack	9313540302512	
AACOMWHITEBL	500053	<b>BUFFING COMPOUND WHITE BLISTER PACK</b> Mostly used in finishing stainless steel. In blister pack	9313540302536	
<b>Bulk Packed</b>				
AACOMGREEN	500046	<b>BUFFING COMPOUND GREEN HIGH POLISH</b> For use with buffing/polishing mops. For a high gloss finish on copper, brass and stainless steel.	9313540300839	
AACOMGREY	500048	<b>BUFFING COMPOUND GREY COURSE CUT</b> For quick removal of deep marks, rust, pitting, in steel etc.	9313540300846	
AACOMRED	500050	<b>BUFFING COMPOUND RED GENERAL PURPOSE</b> For use with buffing/polishing mops. General purpose for copper, brass, aluminium and stainless steel.	9313540300853	
AACOMWHITE	500052	<b>BUFFING COMPOUND WHITE HIGH POLISH</b> Mostly used in finishing stainless steel.	9313540300860	

PART NO.	ITEM	DESCRIPTION	BARCODE	IMAGE
<b>BELT CLEANING STICK</b>				
AASTIK	500212	STIK BELT RESTORER - CARDED Used for unclogging & Rejuvenating Belt & Disc Surfaces	9317987249997	
<b>BUFFING MOPS</b>				
Many applications call for a more refined, brighter finish, from a rough surface to a perfect, mirror-like one. To that effect Abbott & Ashby's range of cloth mops and cutting compounds allow the tradesman to achieve the desired finish in a multitude of materials, from steel to copper, from aluminium to brass and any other metals or alloys encountered in today's workplace.				
<b>Loose Leaf - For Polishing Metals</b>				
AAMOP100/1	500121	LOOSE LEAF MOP 100 x 25 UNPACKED	9313540301638	
AAMOP150/1	500122	LOOSE LEAF MOP 150 x 25 (50 FOLD) RETAIL HANG PACK	9313540301645	
AAMOP200/1	500123	LOOSE LEAF MOP 200 x 25 (50 FOLD) RETAIL HANG PACK	9313540301652	
<b>Stitched - For Heavy Polishing of Metals</b>				
AAMOPST100/1	500162	STITCHED MOP 100 x 25 UNPACKED	9313540301584	
AAMOPST150/1	500163	STITCHED MOP 150 x 25 RETAIL HANG PACK	9313540301591	
AAMOPST200/1	500165	STITCHED MOP 200 x 25 RETAIL HANG PACK	9313540301607	
<b>Industrial Mops - Unpacked</b>				
AAMOPB150/2	500130	CALICO B MOP 150MM X 100 FOLD - LOOSE		
AAMOPB150/3	500131	CALICO B MOP 150MM X 150 FOLD - LOOSE		
AAMOPB150/4	500132	CALICO B MOP 150MM X 200 FOLD - LOOSE		
AAMOPB200/2	500136	CALICO B MOP 200MM X 100 FOLD - LOOSE		
AAMOPB200/3	500137	CALICO B MOP 200MM X 150 FOLD - LOOSE		
AAMOPB200/4	500138	CALICO B MOP 200MM X 200 FOLD - LOOSE		
AAMOPBST150/1	500148	CALICO B MOP 150MM X 50 FOLD-STITCHED		
AAMOPBST150/2	500149	CALICO B MOP 150MM X 100 FOLD-STITCHED		
AAMOPBST150/4	500151	CALICO B MOP 150MM X 200 FOLD-STITCHED		
AAMOPBST200/1	500152	CALICO B MOP 200MM X 50 FOLD-STITCHED		
AAMOPBST200/2	500153	CALICO B MOP 200MM X 100 FOLD-STITCHED		
AAMOPBST200/4	500155	CALICO B MOP 200MM X 200 FOLD-STITCHED		

PART NO.	ITEM	DESCRIPTION	BARCODE	IMAGE
<b>SPINDLES - TAPERED (TO MOUNT BUFFING MOPS ONTO BENCH GRINDERS)</b>				
Bench grinder tapered spindle for the mounting of buffing mops or similar to bench grinders.				
<b>Metric - Right Hand Thread</b>				
AATBE/150RM	500218	TAPERED BUFF EXTENSION 12MM RH SUIT 150MM	9313540302314	
AATBE/200RM	500222	TAPERED BUFF EXTENSION 16MM RH SUIT 200MM	9313540302338	
<b>Metric - Left Hand Thread</b>				
AATBE/150LM	500215	TAPERED BUFF EXTENSION 12MM LH SUIT 150MM	9313540302307	
AATBE/200LM	500220	TAPERED BUFF EXTENSION 16MM LH SUIT 200MM	9313540302321	
<b>SPINDLES - JEWELLERS</b>				
Bench grinder tapered spindle for the mounting small buffing mops or similar to bench grinders. Suitable for jewellery polishing mops				
AATBE/150RJM	500217	JEWELLERS SPINDLE 12MM RH SUIT 150MM A&A	9313540302413	
AATBE/150LJM	500214	JEWELLERS SPINDLE 12MM LH SUIT 150MM A&A	9313540312504	
<b>GRINDING WHEELS (SUIT 150MM + 200MM BENCH GRINDERS)</b>				
Ideal for quick removal of material.				
AAGWA25/150-36	500104	GRINDING WHEEL ALUMINIUM OXIDE 25x150- 36GRIT	9313540301386	
AAGWA25/150-60	500105	GRINDING WHEEL ALUMINIUM OXIDE 25x150- 60GRIT	9313540301393	
AAGWA25/200-36	500107	GRINDING WHEEL ALUMINIUM OXIDE 25x200- 36GRIT	9313540301409	
AAGWA25/200-60	500109	GRINDING WHEEL ALUMINIUM OXIDE 25x200- 60GRIT	9313540301416	
Ideal for more fine work where finish is important. Also suitable for tungsten carbide sharpening.				
AAGWS25/150	500110	GRINDING WHEEL SILICONE CARBIDE 25X150X80GRIT	9313540301454	
AAGWS25/200	500111	GRINDING WHEEL SILICONE CARBIDE 25X200X80GRIT	9313540301461	
Truly Industrial Quality, the closeness and quantity of the wire strands ensures longer, more effective working life. Packed in sturdy hang up display cards. All purpose brushes supplied with multi-fitting bushes 13, 16, 20, 22, 26, 30, 36 and 50mm				
AAWB/150	500225	CRIMPED WHEEL 150 x 22MM, 12MM BORE RETAIL HANG PACK	9313540302284	
AAWB/200	500227	CRIMPED WHEEL 200 x 25MM, 16MM BORE RETAIL HANG PACK	9313540302291	







# *Multitool*

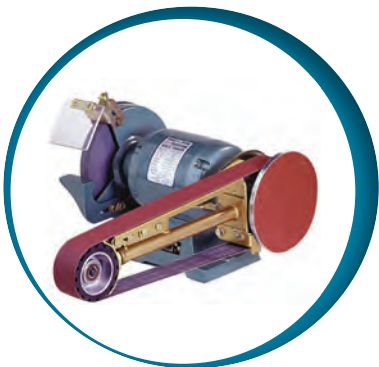

The Ultimate finishing tool.

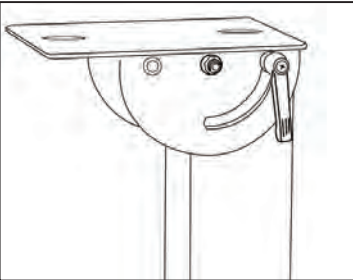
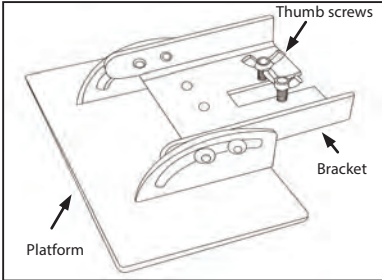
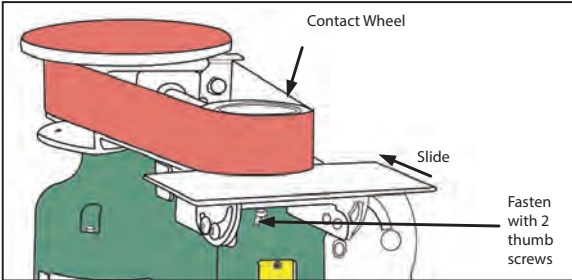
Not Just a Wood Sander. Multitool's patented design is a result of years of research by engineers who have specialised in belt grinding machinery. Superior design and the high tech rubber used in the serrated contact wheel, plus the optimum cutting speed to match the advances in abrasive belt technology make it possible to remove almost any material up to 5 ¼ times faster than the equivalent grit grinding wheel.

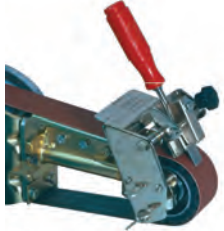

PART NO.	ITEM	DESCRIPTION	BARCODE	IMAGE
<b>BENCH GRINDER ACCESSORIES</b>				
POSPANNER	506954	ADJUSTABLE PIN SPANNER FITS MOST ANGLE GRINDERS	9314294000037	
POS	510920	HEAVY DUTY BENCH GRINDER STAND Suitable for <b>POTST</b> Tilt Conversion Kit	9314294000150	
POTST	510921	TOOL REST & TILT KIT FOR POS STAND Converts <b>POS</b> Bench Grinder Stand into Tilt Stand for all Multitools. Provides a stable platform for more precise grinding.	9314294000149	
		  		
POTS	510919	BENCH GRINDER STAND COMPLETE WITH TILT TABLE (POS + POTST = POTS) <b>This item does NOT come with bench grinder or multitool.</b>	9314294000136	 <p><b>Bench Grinder &amp; Multitool NOT included</b></p>

PART NO.	ITEM	DESCRIPTION	BARCODE	IMAGE
<b>LINISHING ATTACHMENTS</b>				
PO362	506885	<b>MULTITOOL ATTACHMENT #362 50 x 915 MM BELT</b> Belt and disc linishing attachment with a 915mm x 50mm belt, 178mm disc, 89mm contact wheel. Suits most 150mm & 200mm bench grinders with a minimum of 1/3 HP and screw mounted guards. Ideal for those finishing jobs such as tool sharpening, edge sanding, smoothing welds, polishing etc. Use on many materials such as wood, plastics, metals and ceramics with a quick change of belt. Weight 4.88kg	9314294000044	
PO364	506907	<b>MULTITOOL ATTACHMENT #364 100 x 915MM BELT</b> Belt and disc linishing attachment with a 915mm x 100mm belt, 178mm disc, 89mm contact wheel. Suits most 200mm bench grinders with a minimum of 1/2HP and screw mounted guards. Ideal for those finishing jobs such as tool sharpening, edge sanding, smoothing welds, polishing etc. Use on many materials such as wood, plastics, metals and ceramics with a quick change of belt. Weight 6.55kg	9314294000082	
PO482	506917	<b>MULTITOOL ATTACHMENT #482 50 x 1220MM BELT</b> Belt and disc linishing attachment with a 1220mm x 50mm belt, 178mm disc, 89mm contact wheel. Suits most 200mm bench grinders with a minimum of 1/2HP and screw mounted guards. Ideal for those finishing jobs such as tool sharpening, edge sanding, moothing welds, polishing etc. Use on many materials such as wood, plastics, metals and ceramics with a quick change of belt. Weight 5.45kg	9314294000075	 benchgrinder not included
PO484	506923	<b>MULTITOOL ATTACHMENT #484 100 x 1220MM BELT</b> Belt and disc linishing attachment with a 1220mm x 100mm belt, 178mm disc, 89mm contact wheel. Suits most 200mm bench grinders with a minimum of 1/2HP and screw mounted guards. Ideal for those finishing jobs such as tool sharpening, edge sanding, smoothing welds, polishing etc. Use on many materials such as wood, plastics, metals and ceramics with a quick change of belt. Weight 7.57kg	9314294000112	 benchgrinder not included
<b>LINISHING ATTACHMENTS - WITH BENCH GRINDER</b>				
PO362PLUS	506902	<b>362 MULTITOOL FITTED TO 6" INDUSTRIAL GRINDER</b> Belt grinding attachment mounted on the Abbott & Ashby 150mm Industrial Bench Grinder. 50 x 915mm belt. 178mm diameter disc. Ideal for grinding, sanding & polishing. 3 year warranty.	808224000024	
PO362PLUS8	506903	<b>362 MULTITOOL FITTED TO 8" INDUSTRIAL GRINDER</b> Multitool #362 belt grinding attachment mounted on the Abbott & Ashby 200mm Industrial Bench Grinder.	9314294000051	

PART NO.	ITEM	DESCRIPTION	BARCODE	IMAGE
<b>SHARPENING JIG</b>				
POJIG	506944	<b>TOOL SHARPENING JIG SUITS MULTITOOL</b> Multitool sharpenig jig accessory enables a professional result when sharpening chisels, planer blades, and screwdrivers. Easily fitted to multitools. Fits all Multitools except 8CW. For sharpening chisels up to 51mm, plane blades up to 60mm and power planer blades up to 82mm. Slotted screwdrivers up to 10mm square can also be retipped.	8032240000672	
<b>MITRE TABLE ATTACHMENT</b>				
POMTA	506948	<b>MITRE TABLE ATTACHMENT SUITS MULTITOOL</b> Fits all Multitool models. Table can be tilted up 5 degrees & down 50 degrees. Table size is 110 x 204mm. The accurate way to grind ends square and adjust lengths and angles.	9314294000068	
<b>CONTACT WHEELS</b>				
PO3623500	506894	CONTACT WHEEL 89x50 SUITS 362,482,602		
PO3643501	506912	CONTACT WHEEL SUITS 364,484 & 604		
PO2412800	506884	CONTACT WHEEL PORTAGRIND		
<b>DRIVE PULLEYS</b>				
PO3624000	506895	DRIVE PULLEY (7"DISC) SUITS 362,482 & 8CW		
PO3644000	506913	DRIVE PULLEY TO SUIT 364 & 484		
POP9	506949	MULTITOOL DRIVE (9 DISC) 482 & 602		



# STAR-M

## AUGER BITS

 STAR-M - market leader in Innovation & Quality.  
Their ongoing commitment to the study of metallurgy has allowed them to deliver a more durable AUGER that retains its sharpness.

### NO. 4 & NO. 6 SERIES SOFTWOOD DRILL AUGERS

- These ranges are often referred to as CLEAN CUTTING AUGERS, due to the clean cutting wing, or spur on the front.
- The spur pre-cuts the material before the cutting edge & provides a clean entry & exit to the timber.
- The screw point pulls the bit through. The single twist or flute clears the chips & leaves a cylindrical drilling body to aid straight drilling.
- These bits drill a tidy hole without surface breakage & are best suited to SOFT WOODS such as those found in house frames.
- Common users of these auger bits are carpenters, electricians & plumbers.

### NO. 8 HARDWOOD SHIP AUGERS



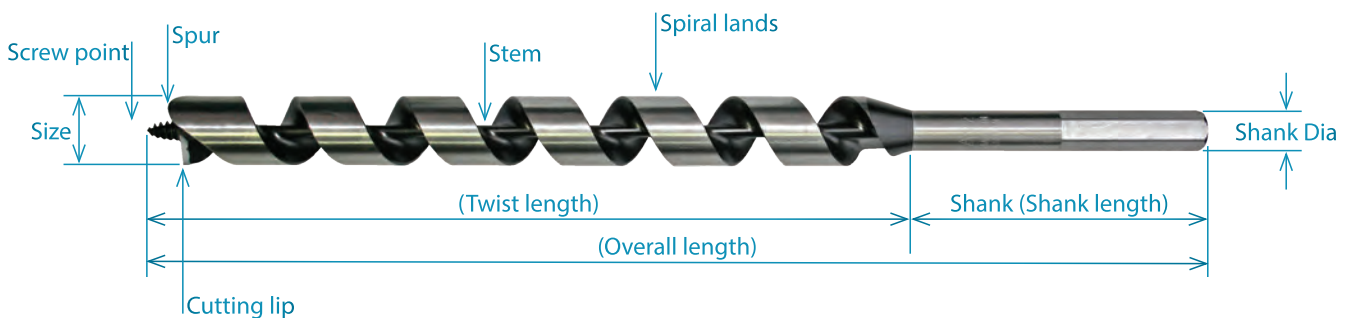

- These are also known as SHIP AUGERS. Hardened to increase bit life.
- Despite a hardness of 57-58 Rockwell C, augers can be sharpened with a needle, diamond file or mounted point.
- Ideal for use in HARDWOOD applications such as telephone poles, timber bridges & pest control applications.
- Ship Augers have an extra cutting edge turning backwards from the leading edge to clear & size the hole. The absence of a cutting wing offers easier drilling through hardwood.



## DESIGNED & MADE FOR AUSTRALIAN TIMBER

Augers are a consumable item, and are not covered by warranty for incorrect use.

PART NO.	ITEM	SIZE	OVERALL LENGTH	TWIST LENGTH	SHANK (Dia)	BARCODE	IMAGE
<b>AUGERS</b>							
<b>NO. 4L - EXTENDED LENGTH DRILL AUGER BITS</b>							
This auger is recommended for deep boring over 240mm. The auger maintains high precision and eliminates lateral vibration.							
<b>STM4L010</b>	704851	10mm	508mm	457mm	9.2mm	4962660350108	
<b>STM4L013</b>	704853	13mm	508mm	457mm	12.3mm	4962660350139	
<b>STM4L016</b>	704855	16mm	508mm	457mm	12.7mm	4962660350160	
<b>STM4L018</b>	704856	18mm	508mm	457mm	12.7mm	4962660350184	
<b>STM4L019</b>	704857	19mm	508mm	457mm	12.7mm	4962660350191	
<b>STM4L021</b>	704858	21mm	508mm	457mm	12.7mm	4962660350214	
<b>STM4L022</b>	704859	22mm	508mm	457mm	12.7mm	4962660350221	
<b>STM4L024</b>	704861	24mm	508mm	457mm	12.7mm	4962660350245	
<b>STM4L025</b>	704862	25mm	508mm	457mm	12.7mm	4962660350252	
<b>NO. 4S - STANDARD DRILL AUGER BITS</b>							
These augers can withstand high speeds yet possess the precision to be used over a wide range of holes from shallow to deep.							
<b>STM4S010</b>	704869	10mm	240mm	180mm	7.0mm	4962660304101	
<b>STM4S011</b>	704870	11mm	250mm	190mm	7.0mm	4962660304118	
<b>STM4S013</b>	704871	13mm	270mm	195mm	12.7mm	4962660304132	
<b>STM4S014</b>	704872	14mm	290mm	210mm	12.7mm	4962660304149	
<b>STM4S016</b>	704873	16mm	290mm	210mm	12.7mm	4962660304163	
<b>STM4S019</b>	704875	19mm	330mm	238mm	12.7mm	4962660304194	
<b>STM4S022</b>	704876	22mm	330mm	238mm	12.7mm	4962660304224	
<b>STM4S025</b>	704877	25mm	330mm	238mm	12.7mm	4962660304255	
<b>NO. 6 - COMBINATION POWER DRILL/HAND BRACE</b>							
The bit is equipped with an axis usable both with electric drill and hand brace. Useful when boring many holes at a time.							
<b>STM6008</b>	704884	8mm	170mm	100mm	7mm	4962660306082	
<b>STM6010</b>	704885	10mm	190mm	119mm	7mm	4962660306105	
<b>STM6011</b>	704886	11mm	190mm	119mm	7mm	4962660306112	
<b>STM6013</b>	704887	13mm	190mm	119mm	7mm	4962660306129	
<b>STM6014</b>	704888	14mm	200mm	129mm	10mm	4962660306143	
<b>STM6016</b>	704889	16mm	200mm	129mm	10mm	4962660306167	
<b>STM6018</b>	704890	18mm	200mm	129mm	10mm	4962660306181	
<b>STM6019</b>	704891	19mm	200mm	129mm	10mm	4962660306198	
<b>STM6021</b>	704892	21mm	210mm	138mm	10mm	4962660306211	
<b>STM6022</b>	704893	22mm	210mm	138mm	10mm	4962660306228	

PART NO.	ITEM	SIZE	OVERALL LENGTH	TWIST LENGTH	SHANK (Dia)	BARCODE	IMAGE
<b>SHIP AUGERS - NO. 8 MEDIUM</b>							
The performance of this auger makes them ideal for use in HARDWOOD applications.							
STM8M010	704930	10mm	305mm	230mm	10mm	9312198853933	
STM8M011	704931	11mm	305mm	230mm	10mm	9312198853940	
STM8M012	704932	12mm	305mm	230mm	11mm	9312198853957	
STM8M013	704933	13mm	305mm	230mm	12mm	9312198853964	
STM8M014	704934	14mm	305mm	230mm	12.55mm	9312198853971	
STM8M016	704935	16mm	305mm	230mm	12.55mm	9312198853988	
STM8M018	704936	18mm	305mm	230mm	12.55mm	9312198853995	
STM8M019	704937	19mm	305mm	230mm	12.55mm	9312198854008	
STM8M022	704938	22mm	305mm	230mm	12.55mm	9312198854015	
STM8M025	704939	25mm	305mm	230mm	12.55mm	9312198854022	
STM8M029	704940	29mm	305mm	230mm	12.55mm	9312198854039	
STM8M032	704941	32mm	305mm	230mm	12.55mm	9312198854046	
<b>SHIP AUGERS - NO. 8 LONG</b>							
The performance of this auger makes them ideal for use in HARDWOOD applications.							
STM8010	704903	10mm	457mm	381mm	10mm	9312198838923	
STM8011	704904	11mm	457mm	381mm	11mm	9312198838930	
STM8012	704905	12mm	457mm	381mm	11mm	9312198855036	
STM8013	704906	13mm	457mm	381mm	12mm	9312198838947	
STM8014	704907	14mm	457mm	381mm	12.55mm	9312198838954	
STM8016	704908	16mm	457mm	381mm	12.55mm	9312198838961	
STM8018	704912	18mm	457mm	381mm	12.55mm	9312198838985	
STM8019	704914	19mm	457mm	381mm	12.55mm	9312198838992	
STM8022	704917	22mm	457mm	381mm	12.55mm	9312198838012	
STM8025	704920	25mm	457mm	381mm	12.55mm	9312198838029	
STM8027	704923	27mm	457mm	381mm	12.55mm	9312198838036	
STM8029	704925	29mm	457mm	381mm	12.55mm	9312198838043	
STM8032	704927	32mm	457mm	381mm	12.55mm	9312198838050	
<b>SHIP AUGERS - NO. 8 EXTRA LONG</b>							
The performance of this auger makes them ideal for use in HARDWOOD applications.							
STM8019L600	704915	19mm	600mm	381mm	12.55mm	9312198848601	
STM8022L600	704919	22mm	600mm	381mm	12.55mm	9312198848618	
STM8025L600	704921	25mm	600mm	381mm	12.55mm	9312198848625	
<b>SHIP AUGERS - NO. 8 EXTRA EXTRA LONG</b>							
The performance of this auger makes them ideal for use in HARDWOOD applications.							
STM8016EXL	704909	16mm	770mm	381mm	12.55mm	9312198848663	





# MORRISON

Woodboring Tools established 1850

Pigeon Brand woodboring auger bits that have been specifically designed and developed for boring Australian Hardwoods.

Manufactured in Sheffield England.

J E Morrison & Sons Ltd. is one of the world's most experienced manufacturers of woodboring tools, with over 160 years accumulated expertise.

All Morrison auger bits are Scotch Pattern, single twist bits needed for hardwood boring with Machine Bits available in 12" with 8" twist & 16" with 12" twist length, 24" Eyed Augers and a small range of shorter auger bits designed for use with a Brace.



PART NO.	ITEM	SIZE	TWIST LENGTH	OVERALL LENGTH	SHANK DIA.	BARCODE	IMAGE	
<b>AUGERS</b>								
<b>EYED AUGER - SCOTCH PATTERN</b>								
The Scotch Pattern Eyed Auger is used for railway track laying work and also for general purpose rough boring. The eye allows a large handle (similar to broom handle) to be inserted into the eye allowing significant leverage when boring holes in hardwood. Typically used when power is not available. 600mm overall length with 175mm twist.								
MR75A08	506196	1/4"(6mm)	175mm (7")	600mm (24")	16mm (5/8")	9313540100019		
MR75A10	506197^	5/16"(8mm)	175mm (7")	600mm (24")	16mm (5/8")	9313540100026		
MR75A12	506198	3/8"(10mm)	175mm (7")	600mm (24")	16mm (5/8")	9313540100033		
MR75A14	506199^	7/16"(11mm)	175mm (7")	600mm (24")	16mm (5/8")	9313540100040		
MR75A16	506200	1/2"(13mm)	175mm (7")	600mm (24")	16mm (5/8")	9313540100057		
MR75A18	506201	9/16"(14mm)	175mm (7")	600mm (24")	16mm (5/8")	9313540100064		
MR75A20	506202	5/8"(16mm)	175mm (7")	600mm (24")	16mm (5/8")	9313540100071		
MR75A22	506203	11/16"(17mm)	175mm (7")	600mm (24")	16mm (5/8")	9313540100088		
MR75A24	506204	3/4"(19mm)	175mm (7")	600mm (24")	16mm (5/8")	9313540100095		
MR75A26	506205^	13/16"(20mm)	175mm (7")	600mm (24")	16mm (5/8")	9313540100101		
MR75A28	506206	7/8"(22mm)	175mm (7")	600mm (24")	16mm (5/8")	9313540100118		
MR75A30	506207	15/16"(24mm)	175mm (7")	600mm (24")	16mm (5/8")	9313540100125		
MR75A32	506208	1"(25mm)	175mm (7")	600mm (24")	16mm (5/8")	9313540100132		
MR75A34	506209^	1.1/16"(26mm)	175mm (7")	600mm (24")	16mm (5/8")	9313540100149		
MR75A36	506210	1.1/8"(28mm)	175mm (7")	600mm (24")	16mm (5/8")	9313540100156		
MR75A40	506211	1.1/4"(32mm)	175mm (7")	600mm (24")	16mm (5/8")	9313540100163		
MR75A44	506212^	1.3/8"(35mm)	175mm (7")	600mm (24")	16mm (5/8")	9313540108220		
MR75A48	506213	1.1/2"(38mm)	175mm (7")	600mm (24")	16mm (5/8")	9313540100170		
MR75A56	506214	1.3/4"(44mm)	175mm (7")	600mm (24")	16mm (5/8")	9313540100194		
MR75A64	506215	2"(50mm)	175mm (7")	600mm (24")	16mm (5/8")	9313540100200		
<b>AUGER BIT FOR BRACE - SCOTCH PATTERN</b>								
The Scotch Pattern Brace Auger is used to bore holes in all varieties of hardwood timber. The unique shank allows the auger to be mounted in a hand brace. Typically used when power is not available. 200-250mm (8"-10") approximate length.								
MR75/98A08	506181^	1/4"(6mm)				9313540100217		
MR75/98A10	506182	5/16"(8mm)				9313540100224		
MR75/98A12	506183	3/8"(10mm)				9313540100231		
MR75/98A14	506184	7/16"(12mm)				9313540100248		
MR75/98A16	506185	1/2"(13mm)				9313540100255		
MR75/98A18	506186	9/16"(14mm)				9313540100262		
MR75/98A20	506187	5/8"(16mm)				9313540100279		
MR75/98A22	506188	11/16"(18mm)				9313540100286		
MR75/98A24	506189	3/4"(19mm)				9313540100293		
MR75/98A26	506190	13/16"(20mm)				9313540100309		
MR75/98A28	506191	7/8"(22mm)				9313540100310		
MR75/98A32	506193	1"(25mm)				9313540100323		
MR75/98A36	506194^	1.1/8"(28mm)						
<b>WAGON BIT - SCOTCH PATTERN</b>								
The Scotch Pattern Auger is used to bore holes in hardwood timber. The round shank allows the auger to be mount in a portable drilling machine. Screw point lead.								
MR89A14	506219^	7/16"(11mm)	250mm (10")	380mm (15")		9313540100507		
MR89A16	506220^	1/2"(13mm)	250mm (10")	380mm (15")		9313540100514		

PART NO.	ITEM	SIZE	TWIST LENGTH	OVERALL LENGTH	SHANK DIA.	BARCODE	IMAGE
<b>MACHINE AUGER - SCOTCH PATTERN</b>							
The Scotch Pattern Machine Auger is used to bore holes in hardwood timber. The round shank allows the auger to be mount in a portable drilling machine. All shanks and twists are machine ground. Typically used for boring holes in railway sleepers and hardwood fences. Screw point lead. This type of bit is made specially for Portable Electric and Pneumatic Drills. Do NOT try to drill beyond the depth of twist, which is likely to cause breakage.							
<b>300mm / 12"</b>							
MR95/12A08	506227^	1/4"(6mm)	200mm (8")	300mm (12")	5.80	9313540100606	
MR95/12A10	506228	5/16"(8mm)	200mm (8")	300mm (12")	5.80	9313540100613	
MR95/12A12	506229	3/8"(10mm)	200mm (8")	300mm (12")	5.45	9313540100620	
MR95/12A14	506230	7/16"(11mm)	200mm (8")	300mm (12")	5.45	9313540100637	
MR95/12A16	506231	1/2"(13mm)	200mm (8")	300mm (12")	5.45	9313540100644	
MR95/12A18	506232	9/16"(14mm)	200mm (8")	300mm (12")	5.80	9313540100651	
MR95/12A20	506233	5/8"(16mm)	200mm (8")	300mm (12")	6.10	9313540100668	
MR95/12A22	506234	11/16"(17mm)	200mm (8")	300mm (12")	6.45	9313540100675	
MR95/12A24	506235	3/4"(19mm)	200mm (8")	300mm (12")	6.90	9313540100682	
MR95/12A26	506236	13/16"(20mm)	200mm (8")	300mm (12")	7.70	9313540100699	
MR95/12A28	506237	7/8"(22mm)	200mm (8")	300mm (12")	8.20	9313540100705	
MR95/12A30	506238^	15/16"(24mm)	200mm (8")	300mm (12")	9.05	9313540100712	
MR95/12A32	506239	1"(25mm)	200mm (8")	300mm (12")	9.25	9313540100729	
MR95/12A36	506240	1.1/8"(28mm)	200mm (8")	300mm (12")	10.80	9313540100736	
MR95/12A40	506241	1.1/4"(32mm)	200mm (8")	300mm (12")	11.55	9313540100743	
<b>400mm / 16"</b>							
MR95/16A08	506242^	1/4"(6mm)	300mm (12")	400mm (16")	8.70	9313540100750	
MR95/16A10	506243	5/16"(8mm)	300mm (12")	400mm (16")	8.70	9313540100767	
MR95/16A12	506244	3/8"(10mm)	300mm (12")	400mm (16")	8.35	9313540100774	
MR95/16A14	506245	7/16"(11mm)	300mm (12")	400mm (16")	8.35	9313540100781	
MR95/16A16	506246	1/2"(13mm)	300mm (12")	400mm (16")	8.35	9313540100798	
MR95/16A18	506247	9/16"(14mm)	300mm (12")	400mm (16")	8.70	9313540100804	
MR95/16A20	506248	5/8"(16mm)	300mm (12")	400mm (16")	9.05	9313540100811	
MR95/16A22	506249	11/16"(17mm)	300mm (12")	400mm (16")	9.45	9313540100828	
MR95/16A24	506250	3/4"(19mm)	300mm (12")	400mm (16")	9.75	9313540100835	
MR95/16A26	506251	13/16"(20mm)	300mm (12")	400mm (16")	10.45	9313540100842	
MR95/16A28	506252	7/8"(22mm)	300mm (12")	400mm (16")	10.70	9313540100859	
MR95/16A30	506253	15/16"(24mm)	300mm (12")	400mm (16")	11.10	9313540100866	
MR95/16A32	506254	1"(25mm)	300mm (12")	400mm (16")	11.50	9313540100873	
MR95/16A36	506255	1.1/8"(28mm)	300mm (12")	400mm (16")	12.25	9313540100880	
MR95/16A40	506256	1.1/4"(32mm)	300mm (12")	400mm (16")	13.85	9313540100897	





Visit our website: [www.whiteint.com.au](http://www.whiteint.com.au)  
For the latest news and information.





## Experience

Servicing industry since 1962, Menlo USA is a leading manufacturer & supplier of superior quality cylindrical carbide cutting tools. All products are made in Warren, Michigan USA.

## Accuracy

Attention to detail is what sets Menlo Carbide Burrs & products apart. Menlo Carbide Burrs are renown for their excellent surface quality, high cutting performance & long cutting life.

## Quality & Service

At Menlo, quality control is paramount. Certifications such as Ford Motor Company's Q1 rating attest to Menlo's commitment to provide superior products professionals can rely on.

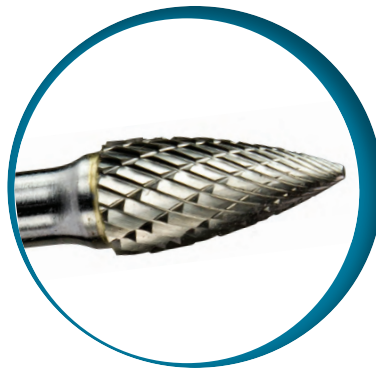

## Operating Recommendations

- Burrs should always be run at high speeds using a die grinder.
- Electric Power tools are too slow & will cause "Chatter" & breakage.
- The Burr should be at full speed before it makes contact with the work piece.
- Allow the Burr to cut on its own. Do not apply excessive force.
- Place the Burr as far back as you can in your Die grinder.
- If sparks are evident, either the burr is worn out or the work piece material is too hard.
- Carbide is a hard & brittle material.
- Burrs should not be dropped or used on fully hardened steels.
- Only 30% of a Burr should be in contact with the work piece at any one time. Do not use them like a drill.
- Instead, the Burr should be used in a clockwise direction around a hole.
- Optimum results will be achieved through constant light pressure in a clockwise direction. Smooth light pressure will result in a better finish, superior metal removal & a longer life of your Burr.
- Where possible, Aluminium Cut Burrs should be coated with a lubricant to aid chip removal. These burrs tend to 'clog' up during use.
- Suggested Burr speeds for Burrs are shown in the table at the end.









## WARRANTY:

**Burrs are a consumable item & will wear out. Any returned burr that exhibits any of the below 'Signs of Misuse' will not be covered by warranty**

### Signs of misuse are:

- Chips without any other damage. This is caused by the Burr being dropped.
- The Burr head is missing & is discoloured. This is caused by too much pressure overheating the Burr resulting in the brazed joint melting.
- Radial chipping around the Burr. This is caused by the Burr being used in too small a hole.
- Erratic chipping of the Burr. This is caused by the Burr being used at too slow a speed (usually in a power tool)



PART NO.	ITEM	Part Nos.			Cutter		Shank Dia.	Overall Length	BARCODE	IMAGE
		Garryson	Bordo	Suttons	Dia.	Length				
<b>DOUBLE CUT BURRS</b>										
<b>"B" - BALL SHAPE BURRS - DOUBLE CUT</b>										
MENBB2(1)D	703229	7200-8C	SD-42	SD420	1/8	3/32	1/8	1 1/2	69796700754	
MENBB4D	703234	7400-4C	SD-1	SD100	1/4	7/32	1/4	2	69796700791	
MENBB5D	703236	7500-4C	SD-2	SD200	5/16	1/4	1/4	2 1/4	69796700811	
MENBB6D	703238	7600-4C	SD-3	SD300	3/8	5/16	1/4	2 5/16	69796700821	
MENBB8D	703242	7700-4C	SD-5	SD500	1/2	7/16	1/4	2 9/16	69796700831	
<b>"CO" - CONE SHAPE BURRS - DOUBLE CUT</b>										
MENBCO4(3)D	703249		SM-3	SM300	1/4	1	1/4	2	69796701084	
MENBCO6D	703251	2600-4C	SM-4	SM400	3/8	5/8	1/4	2 5/8	69796701104	
MENBCO8D	703252	2700-4C	SM-5	SM500	1/2	7/8	1/4	2 7/8	69796701114	
<b>"CP" - CYLINDER SHAPE PLAIN END BURRS - DOUBLE CUT</b>										
MENBCP2(1)D	703264	1200-8C	SA-43		1/8	9/16	1/8	1 1/2	69796700124	
MENBCP4D	703273	1400-4C	SA-1		1/4	5/8	1/4	2	69796700164	
MENBCP5D	703276	1500-4C	SA-2		5/16	3/4	1/4	2 3/4	69796700194	
MENBCP6D	703279	1600-4C	SA-3		3/8	3/4	1/4	2 3/4	69796700204	
MENBCP8D	703285	1700-1-4C	SA-5		1/2	1	1/4	3	69796700224	
MENBCP10D	703255	1800-4C	SA-6		5/8	1	1/4	3	69796700234	
<b>"CP" - CYLINDER SHAPE WITH END CUT BURRS - DOUBLE CUT</b>										
MENBCP4D-E	703274	1402-4C	SB-1	SA100	1/4	5/8	1/4	2	69769790164	
MENBCP5D-E	703277	1502-4C	SB-2	SA200	5/16	3/4	1/4	2 3/4	69796790194	
MENBCP6D-E	703280	1602-4C	SB-3	SA300	3/8	3/4	1/4	2 3/4	69796790204	
MENBCP7D-E	703283		SB-4	SA400	7/16	1	1/4	3	69796790214	
MENBCP8D-E	703286	1702-1-4C	SB-5	SA500	1/2	1	1/4	3	69796790224	
MENBCP10D-E	703256	1802-4C	SB-6	SA600	5/8	1	1/4	3	69796790234	
<b>"CR" - CYLINDER SHAPE RADIUS END BURRS - DOUBLE CUT</b>										
MENBCR4D	703299	3400-4C	SC-1	SC100	1/4	5/8	1/4	2	69796700324	
MENBCR5D	703301	3500-4C	SC-2	SC200	5/16	3/4	1/4	2 3/4	69796700344	
MENBCR6D	703303	3600-4C	SC-3	SC300	3/8	3/4	1/4	2 3/4	69796700354	
MENBCR8D	703307	3700-1-4C	SC-5	SC500	1/2	1	1/4	3	69796700374	
MENBCR10D	703290	3800-4C	SC-6	SC600	5/8	1	1/4	3	69796700384	
<b>"F" - FLAME SHAPE BURRS - DOUBLE CUT</b>										
MENBF5D	703313	5550-4C	SH-2	SH200	5/16	3/4	1/4	2 3/4	69796700984	
MENBF8D	703315	5600-4C	SH-5	SH500	1/2	1 1/4	1/4	3 1/4	69796700994	
MENBF10D	703309		SH-6	SH600	5/8	1 7/16	1/4	3 7/16	69796701004	
<b>"OV" - OVAL SHAPE BURRS - DOUBLE CUT</b>										
MENBOV4D	703330		SE-1	SE100	1/4	3/8	1/4	2	69796700684	
MENBOV6D	703333	5500-4C	SE-3	SE300	3/8	5/8	1/4	2 5/8	69796700704	
MENBOV8D	703336	5700-4C	SE-5	SE500	1/2	7/8	1/4	2 7/8	69796700714	
<b>"T" - 14 DEGREE TAPER SHAPE RADIUS END BURRS - DOUBLE CUT</b>										
MENBT4D	703344	4400-4C	SL-1	SL100	1/4	5/8	1/4	2	69796700904	
MENBT5D	703346		SL-2	SL200	5/16	7/8	1/4	2 7/8	69796700914	
MENBT6D	703348	4600-1-4C	SL-3	SL300	3/8	1 1/16	1/4	3 1/16	69796700924	
MENBT8D	703351	4700-4C	SL-4	SL400	1/2	1 1/8	1/4	3 1/8	69796700934	
MENBT10D	703339	4800-4C	SL-6	SL600	5/8	1 5/16	1/4	3 5/16	69796700944	

\*\*Please note that other shapes and sizes of Menlo burrs are available upon request.\*\*

PART NO.	ITEM	Part Nos.			Cutter		Shank Dia.	Overall Length	BARCODE	IMAGE
		Garryson	Bordo	Suttons	Dia.	Length				
<b>"TP" - TREE SHAPE POINTED END BURRS - DOUBLE CUT</b>										
MENBTP6D	703362	6500-4C	SG-3	SG300	3/8	3/4	1/4	2 3/4	69796700604	
MENBTP8(2)D	703363	6800-4C	SG-5	SG500	1/2	1	1/4	3	69796700624	
<b>"TR" - TREE SHAPE RADIUS END BURRS - DOUBLE CUT</b>										
MENBTR4D	703373	9400-4C	SF-1	SF100	1/4	3/4	1/4	2	69796700444	
MENBTR6D	703376	9600-4C	SF-3	SF300	3/8	3/4	1/4	2 3/4	69796700464	
MENBTR8(2)D	703380	9700-4C	SF-5	SF500	1/2	1	1/4	3	69796700484	
MENBTR10D	703365	9800-4C	SF-6	SF600	5/8	1	1/4	3	69796700494	
<b>ALUMINIUM CUT BURRS</b>										
<b>"CP" - CYLINDER SHAPE BURRS - ALUMINIUM CUT WITH END CUT</b>										
MENBCP6A	703278	TTA260-4	SB-3NF	SB3AC	3/8	3/4	1/4	2 3/4	69796701212	
MENBCP8A	703284	TTA270-4	SB-5NF	SB5AC	1/2	1	1/4	3	69796701213	
<b>"CR" - CYLINDER SHAPE RADIUS END BURRS - ALUMINIUM CUT</b>										
MENBCR4A	703298		SC-1NF	SC1AC	1/4	3/4	1/4	2	69796701221	
MENBCR6A	703302	TTA360-4	SC-3NF	SC3AC	3/8	3/4	1/4	2 3/4	69796701222	
MENBCR8A	703306	TTA370-4	SC-5NF	SC5AC	1/2	1	1/4	3	69796701223	
<b>"OV" - OVAL SHAPE BURRS - ALUMINIUM CUT</b>										
MENBOV4A	703329		SE-1NF	SE1AC	1/4	3/8	1/4	2	69796701241	
<b>"T" - 14 DEGREE TAPER SHAPE RADIUS END BURR - ALUMINIUM CUT</b>										
MENBT8A	703350	TTA470-4	SL-4NF	SL4AC	1/2	1 1/8	1/4	3 1/8	69796701253	
<b>"TR" - TREE SHAPE RADIUS END BURRS - ALUMINIUM CUT</b>										
MENBTR6A	703375	TTA960-4	SF-3NF	SF3AC	3/8	3/4	1/4	2 3/4	69796701232	
MENBTR8(2)A	703379	TTA970-4	SF-5NF	SF5AC	1/2	1	1/4	3	69796701233	

**\*\*Please note that other shapes and sizes of Menlo burrs are available upon request.\*\***



<b>SUGGESTED BURR SPEEDS</b>				
Cutter Dia. "	Cutter Dia. mm	Double Cut	Aluminium Cut	
1/16	1.6	60,000	-	Speeds shown are a starting point only for common materials such as steel. Variations may be required to achieve optimum results and where the work piece is a harder or softer material. Extra Long Burrs should be used at reduced speeds.
1/8	3.18	40,000	-	
3/16	4.76	35,000	-	
1/4	6.35	30,000	22,000	
5/16	7.94	20,000	15,000	
3/8	9.53	20,000	15,000	
1/2	12.7	15,000	11,000	
5/8	15.88	12,000	9,000	
3/4	19.05	10,000	7,500	
1	25.4	7,500	5,500	

PART NO.	ITEM	Part Nos.			Cutter		Shank Dia.	Overall Length	BARCODE	IMAGE
		Garryson	Bordo	Suttons	Dia.	Length				
<b>DOUBLE CUT BURR SETS</b>										
MENBURRUNIT8	703383	<b>BURR SET 8 PIECE SET WITH 3/8" BURRS</b> Includes - 8 popular 3/8" burrs with 1/4" shanks in a plastic case. MENBB6D Ball Shape, MENBCO6D Cone Shape, MENBCP6D Cylindrical - Plain End, MENBCR6D Cylindrical - Radius End, MENBOV6D Oval Shape, MENBT6D Taper Shape, MENBTP6D Tree Shape - Pointed End, MENBTR6D Tree Shape - Radius End					69769701487			
MENBTOOL13	703353	<b>BURR SET 12 PIECE SET WITH 1/8" SHANK</b> Includes - 12 burrs (includes every shape available) with 1/8" shanks in a plastic case. MENBB2(1)D Ball Shape 1/8" burr MENBCO2(2)D Cone Shape 1/8" burr MENBCP1.5D Cylindrical - Plain End 3/32" burr MENBCP2(1)D Cylindrical - Plain End 1/8" burr MENBCR1.5D Cylindrical - Radius End 3/32" burr MENBCR2(1)D Cylindrical - Radius End 1/8" burr MENBF2(1)D Flame Shape 1/8" burr MENBIC2(1)D Inverted Cone Shape 1/8" burr MENBOV2(1)D Oval Shape 1/8" burr MENBT2(2)D Taper Shape 1/8" burr MENBTP2(3)D Tree Shape - Pointed End 1/8" burr MENBTR2(1)D Tree Shape - Radius End 1/8" burr					69769701454			
<b>MERCHANDISING STAND</b>										
MENBURR48	801103	<b>MERCHANDISING STAND 48 PIECE</b> 48 popular burrs with 1/4" shanks in a Perspex® display case. Includes: 2 of each of the following burrs  MENBB4D Double Cut Ball 1/4" burr MENBB6D Double Cut Ball 3/8" burr MENBCP4D Double Cut Plain End Cylinder 1/4" burr MENBCP4D-E Double Cut With End Cut Cylinder 1/4" burr MENBCP6D-E Double Cut With End Cut Cylinder 3/8" burr MENBCP8D-E Double Cut With End Cut Cylinder 1/2" burr MENBCR4D Double Cut Radius End Cylinder 1/4" burr MENBCR5D Burr Double Cut Radius End Cylinder 5/16" burr MENBCR6D Double Cut Radius End Cylinder 3/8" burr MENBCR8D Double Cut Radius End Cylinder 1/2" burr MENBF5D Double Cut Flame 5/16" burr MENBF8D Double Cut Flame 1/2" burr MENBOV6D Double Cut Oval 3/8" burr MENBOV8D Double Cut Oval 1/2" burr MENBT5D Double Cut Taper 5/16" burr MENBT6D Double Cut Taper 3/8" burr MENBT8D Double Cut Taper 1/2" burr MENBT10D Double Cut Taper 5/8" burr MENBTP6D Double Cut Pointed End Tree 3/8" burr MENBTR8(2)D Double Cut Radius End Tree 1/2" burr MENBTR4D Double Cut Radius End Tree 1/4" burr MENBTR6D Double Cut Radius End Tree 3/8" burr MENBCP6A Aluminium Cut End Cut Cylinder 3/8" burr MENBCR6A Aluminium Cut Radius End Cylinder 3/8" burr								



# Q-Bond<sup>®</sup>

Ultra Strong Adhesive & Filling Powders  
Q-Bond repairs almost anything!  
Sets Rock Hard in 10 seconds

Q-Bond can be used just as an adhesive  
or with the reinforcing powders that will help  
to repair ALMOST ANYTHING!



PART NO.	ITEM	DESCRIPTION	BARCODE	IMAGE
<b>Q BOND GLUE</b>				
Repair Kits & Super Glue. For repairing various types of breaks, cracks and other types of damage. Using the two part system with unique reinforcing and filling capabilities cracks, holes and gaps can be repaired to regain their original shape				
QB2	507043	<b>ADHESIVE SMALL REPAIR KIT</b>  Contains 2 x 10ml Adhesive 1 x Grey Powder 1 x Black Powder  For repairing various types of breaks, cracks and other types of damage. Using the two part system with unique reinforcing and filling capabilities cracks, holes and gaps can be repaired to regain their original shape.	6001651023565	
QB3	507044	<b>ADHESIVE LARGE REPAIR KIT</b>  Contains 6 X 10ml Adhesive 2 X Black Powder 1 X Grey Powder  For repairing various types of breaks, cracks and other types of damage. Using the two part system with unique reinforcing and filling capabilities cracks, holes and gaps can be repaired to regain their original shape.	6008075006068	
QB4	507045	<b>ADHESIVE 10ML SUPERGLUE</b> (Sold Only in boxes of 12)	9313540201662	



**Ultra Strong Adhesive & Filling Powders**  
**Q-Bond repairs almost anything!**  
**Sets Rock Hard in 10 seconds**

**Q-Bond can be used just as an adhesive or with the reinforcing powders that will help to repair ALMOST ANYTHING!**







**Q-Bond®**



# *Fascor*

Fascor is a specialist manufacturer and supplier of precision, high quality fastening solutions. The products are obtained from their own manufacturing facilities as well as from associated facilities where quality is strictly controlled by Fascor.



PART NO.	ITEM	DESCRIPTION	BARCODE	IMAGE
<b>RIVETERS</b>				
<b>PLIER TYPE</b>				
FH10MK11C	502258	<b>RIVETER PLIER TYPE (NEW STYLE)</b> A tool for DIY enthusiast and tradesman and light engineering work. Sets 3,2/4,0/4,8 mm aluminium rivets. Hand assembly ergonomically designed to suit all hand sizes. Durable PVC coated handle. Steel fabricated epoxy coated tool body. Supplied with additional nose pieces in a handy location on the tool body, together with a spanner. Jaws can be cleaned without totally disassembling the tool. Jaw case assembly can be replaced without total tool disassembly. Nose body modified to fit into smaller applications. Lever pivot pin hole now burst pierced adding more than twice the strength and tool life. New technology manufacturing process ensuring a precision product. Improved return spring and spring pin. Stringent quality control - ISO9001	6002247042151	
<b>SCISSOR TYPE</b>				
FH2448	502269	<b>RIVETER SCISSOR TYPE LONG HANDLE</b> A powerful "scissor type" riveting tool for Light Industrial use. Sets 3,2 / 4,0 / 4,8 mm aluminium and steel blind rivets. Strong enough to set a 4,8 mm steel rivet, but <b>NOT</b> suitable for stainless steel Rivets. Advantages of this tool is that it pushes away from the work surface when setting a rivet, ensuring no scratching of the work piece. "Scissor type" action for easy use above your head. Presented in a robust easy carry pouch	6002247042243	
FH2464	502271	<b>RIVETER SCISSOR TYPE LONG HANDLE - HEAVY DUTY</b> A powerful "scissor type" riveting tool for Heavy Industrial use. Sets 3,2 / 4,0 / 4,8 / 6,4 mm aluminium and steel blind rivets. Will set rivet with stainless steel body and steel mandrel up to 4.8mm, but <b>cannot</b> be used for stainless steel mandrel on 4.8mm stainless steel body rivet. Advantages of this tool is that it pushes away from the work surface when setting a rivet, ensuring no scratching of the work piece. "Scissor type" action for easy use above your head. Presented in a robust easy carry pouch.	6002247042250	
<b>LAZY TONG TYPE</b>				
FH44	502274	<b>RIVETER LAZY TONG</b> A powerful "lazy tong" concertina type tool for Light Industrial use. Sets 3,2 / 4,0 / 4,8 mm aluminium and steel blind rivets. Fascor's FH-44 is tough. Tough enough to take the worst abuse. Strong enough to set a 4,8 mm steel rivet, but <b>NOT</b> suitable for stainless steel Rivets. Cast-in nose bush that does not work loose. Improved lattice to body fixing. Riveted lattice to handle fixing. Presented in a robust easy carry pouch.	6002247042229	
FH64	502283	<b>RIVETER LAZY TONG - HEAVY DUTY</b> A powerful "lazy tong" concertina type tool for Heavy Industrial use. Sets 3,2 / 4,0 / 4,8 and 6,4mm aluminium and steel blind rivets. Fascor's FH-64 is tough. Tough enough to take the worst abuse. Strong enough to set a 6,4 mm steel rivet. Will set rivet with stainless steel body and steel mandrel up to 4.8mm, but <b>cannot</b> be used for stainless steel mandrel on 4.8mm stainless steel body rivet. Improved narrow lattice to body fixing to increase lverage. Solid steel end cap for access to jaws for cleaning and replacement. Riveted lattice to handle fixing. Presented in a robust easy carry pouch.	6002247042226	

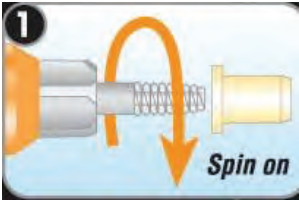
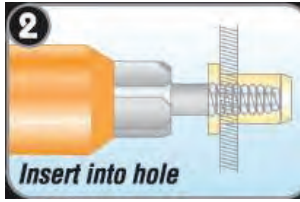
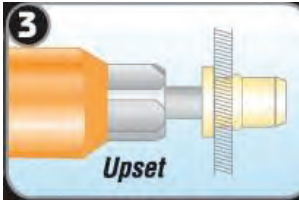
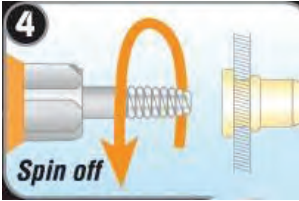

PART NO.	ITEM	DESCRIPTION	BARCODE	IMAGE
<b>RIV-NUTTERS</b>				
<b>PLIER TYPE</b>				
FH20	502260	RIV-NUTTER KIT IN POUCH WITH RIVNUTS FH20 Threaded Insert Setting tool is ideal for the DIY enthusiast and the tradesman. Places threaded inserts M4, M5, and M6. Presented in a robust easy carry pouch with selection of threaded inserts. Kit includes a set of nose pieces and attachments, a spanner, and threaded inserts.	6002247003572	
<b>LAZY TONG TYPE</b>				
<p>Handle designed to suit all hand sizes. Nose body modified to fit into larger applications. Advanced technology manufacturing process ensuring a precision product. Stringent quality control – ISO 9002. Packaging available in a compact easy carry pouch. Uses: Automotive, Furniture, Security, Boating, Electronic, Leisure, Building DIY etc. Replacement inserts available. 10 YEAR FACTORY BACKED WARRANTY</p>      				
FH40	502273	RIV-NUTTER LAZY TONG 6 & 8mm INSERTS	6002247006863	
FH60	502282	RIV-NUTTER LAZY TONG 6, 8,10,12mm INSERTS	6002247006870	
<b>RIV-NUT SPARES</b>				
FH20-6/4	502263	RIV-NUT SPARE 4MM MANDREL NUT		
FH20-6/5	502264	RIV-NUT SPARE 5MM MANDREL NUT		
FH20-6/6	502265	RIV-NUT SPARE 6MM MANDREL NUT		
FH20-7/4	502266	RIV-NUT SPARE 4MM MANDREL		
FH20-7/5	502267	RIV-NUT SPARE 5MM MANDREL		
FH20-7/6	502268	RIV-NUT SPARE 6MM MANDREL		
<b>RIV-NUT INSERTS</b>				
FHRIVM4LFS	502293	RIV-NUT INSERTS 4MM (PACK OF 25)	6002247003695	
FHRIVM5LFS	502294	RIV-NUT INSERTS 5MM (PACK OF 25)	6002247003701	
FHRIVM6LFS	502295	RIV-NUT INSERTS 6MM (PACK OF 20)	6002247003718	
FHRIVM8LFS	502296	RIV-NUT INSERTS 8MM (PACK OF 20)	6002247007198	
FHRIVM10LFS	502291	RIV-NUT INSERTS 10MM (PACK OF 20)	6002247007204	
FHRIVM12LFS	502292	RIV-NUT INSERTS 12MM (PACK OF 15)	6002247007211	

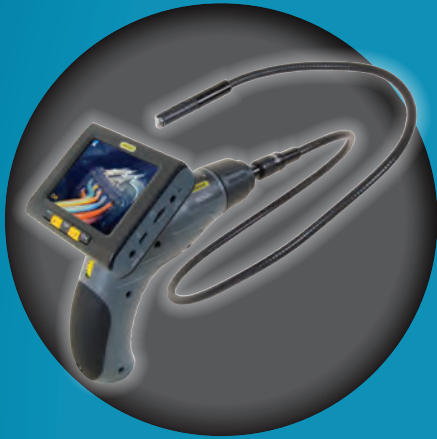

Visit our website: [www.whiteint.com.au](http://www.whiteint.com.au)  
For the latest news and information.





# TACWISE<sup>TM</sup>

Staplers & Tackers for the professional tradesman and discerning DIY users. All tacker bodies are constructed from either Zinc, using our unique Zinc die-cast extrusion process, or resilient polymer materials. Tacwise is a brand of rugged fastening tools for the professional tradesman. High quality, feature packed and hard wearing with a robust and practical design.



PART NO.	ITEM	DESCRIPTION	BARCODE	IMAGE
<b>NAIL GUNS</b>				
<b>STAPLER / TACKER</b>				
The small grip is ideal for smaller hands yet perfect for tough industrial tasks such as fixing wire. Uses staple #53 length 4-8mm				
TAZ1-53TB	508864	STAPLE TACKER (BLACK) 4-8MM NO.53 STAPLES	501850503365	
TAZ1-53	508861	METAL STAPLE TACKER 4-8MM NO. 53 STAPLES	5018505036580	
TAZ3-140L	508868	LIGHTWEIGHT STAPLE TACKER 6-14MM STAPLES	5018505028479	
TAZ3-140	508867	HEAVY DUTY METAL STAPLE TACKER 6-14MM NO. 140 STAPLES Heavy Duty, hand operated staple gun. Shoot six sizes of T50 staples. Ideal for pictures frames, upholstery etc.	5018505028455	
<b>TACKERS</b>				
<b>CABLE TACKER</b>				
TAZ3-CT45	508869	CABLE TACKER 8-10MM CT45 OR T18 STAPLES Designed to bring speed, comfort and precision to a task of low voltage cable tacking, this high impact tool features a new advanced system for recoilless action and incorporates many safety features	5018505028271	
TAZ3-CT60	508870	CABLE TACKER 10-14MM CT60 or T25 STAPLES BT approved, these top end tools make light work of fastening telecommunications, alarm and other low voltage cables. Ideal for fixing neatly and securely into tight corners.	5018505036948	
TACOMBI	511171	COMBI TACKER SUITS CT45 & CT60 STAPLES	5051439002467	
				

PART NO.	ITEM	DESCRIPTION	BARCODE	IMAGE
<b>HAMMER TACKER</b>				
TAA11	508845	HAMMER TACKER 6-10MM NO. 140 or T50 STAPLES 6-10mm, #140 (T50) staples All steel "slap" hammer designed with few working parts for years of trouble free operation. Popular for securing flooring underlay, plastic sheeting and breather membrane	5018505010924	
<b>STAPLER / NAILER</b>				
TA140EL	508817	140EL ELECTRIC STAPLER / BRAD NAILER Suitable for professionals such as builders and tradesmen. Taking the popular #140 (T50) flat wire staple in lengths 6mm to 14mm and 180/15mm series nails	5051439001354	
<b>PROFESSIONAL NAIL GUNS</b>				
TA191EL	508823	NAIL GUN WITH CASE 191EL ELECTRIC PRO NAIL/STAPLER Market favourite nail/staple gun. This tool is highly balanced and ergonomically designed for continuous fastening tasks. Shoots staples & nails up to 35mm long.	5051439001217	
<b>CONSUMABLES</b>				
<b>NO. 53 STAPLES SUITS NO. 53 TACKERS AND ARROW JT21</b>				
TA53/06	508833	NO.53 STAPLES 6MM (2,000/BOX)	5018505100397	
TA53/06B	508834	NO.53 STAPLES 6MM (5,000/BOX)	5018505555401	
TA53/08	508835	NO.53 STAPLES 8MM (2,000/BOX)	5018505100403	
TA53/08B	508836	NO.53 STAPLES 8MM (5,000/BOX)	5018505555418	
TA53/10	508837	NO.53 STAPLES 10MM (2,000/BOX)	5018505100410	
TA53/10B	508838^	NO.53 STAPLES 10MM (5,000/BOX)	5051439000135	
TA53/12B	508839	NO.53 STAPLES 12MM (5,000/BOX)	5051439000036	
TA53/14B	508840	NO.53 STAPLES 14MM (5,000/BOX)	5051439000074	
<b>NO. 140 STAPLES SUITS NO. 140 TACKERS AND ARROW T50</b>				
TA140/06	508805	NO.140 STAPLES 6MM (2,000/BOX)	5018505016926	
TA140/08	508807	NO.140 STAPLES 8MM (2,000/BOX)	5018505016940	
TA140/10	508809	NO.140 STAPLES 10MM (2,000/BOX)	5018505016964	
TA140/12	508812	NO.140 STAPLES 12MM (2,000/BOX)	5018505016988	
TA140/14	508814	NO.140 STAPLES 14MM (2,000/BOX)	5018505170086	
TA140/10SS	508811	NO.140 STAINLESS STEEL STAPLES 10MM x 5M	5051439000395	
TA140/06B	508806	NO.140 STAPLES 6MM (5,000/BOX)	5018505555104	
TA140/08B	508808	NO.140 STAPLES 8MM (5,000/BOX)	5018505555128	
TA140/10B	508810	NO.140 STAPLES 10MM (5,000/BOX)	5018505555142	
TA140/12B	508813	NO.140 STAPLES 12MM (5,000/BOX)	5018505555326	
TA140/14B	508815	NO.140 STAPLES 14MM (5,000/BOX)	5018505002264	
TA140/6-14	508816	NO.140 STAPLE SELECTION PACK 6-14MM	5018505555548	

PART NO.	ITEM	DESCRIPTION	BARCODE	IMAGE
<b>CABLE STAPLES CT45 / CT60</b>				
TACT45/08	508846	CABLE STAPLES 8 x 6.3MM (5,000/BOX)	5018505104388	
TACT45/10	508847	CABLE STAPLES 10 x 6.3MM (5,000/BOX)	5018505104395	
TACT60/10	508848	CABLE STAPLES 10 x 7.6MM (5,000/BOX)	5018505025188	
TACT60/12	508849	CABLE STAPLES 12 x 7.6MM (5,000/BOX)	5018505104456	
TACT60/14	508850	CABLE STAPLES 14 X 7.6MM (5,000/BOX)	5018505104463	
<b>NO. 180 NAILS FOR TA191EL</b>				
TA180/15	508818	NO.180 NAILS 15MM (2,000/BOX)	5018505016209	
TA180/25	508819	NO.180 NAILS 25MM (1,000/BOX)	5018505028738	
TA180/30	508820	NO.180 NAILS 30MM (1,000/BOX)	5018505028745	
TA180/32	508821	NO.180 NAILS 32MM (1,000/BOX)	5018505028783	
<b>NO. 91 STAPLES FOR TA191EL</b>				
TA91/20	508842	NO.91 STAPLES 20MM (1,000/BOX)	5018505103107	
TA91/25	508843	NO.91 STAPLES 25MM (1,000/BOX)	5018505103121	
TA91/30	508844	NO.91 STAPLES 30MM (1,000/BOX)	5018505103145	

# Estwing

Solid Steel Striking Tools. Made in USA since 1923.





Solid Steel Forged Hammers, Axes & Picks are available with the Estwing iconic Leather Grip or with the Estwing patented Vinyl shock reduction grip, which was introduced in 2001. The vinyl grip dramatically reduces vibration during striking as well as providing improved comfort and durability.

Estwing continues to innovate and produce new hand tools for the Trade and serious DIY users. Their engineers work continually to create the most revolutionary and long lasting hand tools on the market.







PART NO.	ITEM	DESCRIPTION	BARCODE	IMAGE
<b>AXES</b>				
<b>CAMPERS AXE</b>				
		Nylon Vinyl Shock Reduction Grip® Estwing's Camper's Axe is forged in one piece steel with exclusive Shock Reduction Grip®, and it comes with an embossed leather sheath.		
EWE44A	502193	AXE CAMPERS 400MM WITH SHEATH Cutting Edge : 4" / 102 mm	034139670018	
EWE45A	502194	AXE CAMPERS 660MM WITH SHEATH Cutting Edge : 4" / 102 mm	034139670216	
EWS	502152	# 5 REPLACEMENT LEATHER SHEATH FOR E44A & E45A	034139810810	
<b>WOOD SPLITTING TOOL - FIRESIDE FRIEND®</b>				
		Nylon Vinyl Shock Reduction Grip® Estwing's Fireside Friend® Splitting Tool is forged in one piece. The handle length and weight give leverage and power for easy wood splitting		
EWE3-FF4	502190	FIRESIDE FRIEND SPLITTING TOOL 350MM NYLON GRIP Cutting Edge: 2-3/8" / 60 mm	034139610311	
<b>SPORTSMANS AXE</b>				
		World famous Sportsman's Axes are the choice of outdoorsmen everywhere. This axe is forged in one piece with a genuine leather grip. A must for all campers! Includes an embossed leather sheath.		
EWE14A	502164	AXE SPORTSMANS 300MM LEATHER GRIP, with #2 leather sheath Cutting Edge : 2 3/4" / 70 mm	034139611219	
EWE24A	502166	AXE SPORTSMANS 350MM LEATHER GRIP, with #1 leather sheath Cutting Edge : 3 1/4" / 83 mm	034139612414	
<b>CARPENTERS HATCHET</b>				
		Nylon Vinyl Shock Reduction Grip® Estwing's Solid Steel Carpenters Hatchet have bonded and moulded Shock Reduction Grip® which offers the utmost in both comfort and durability, while reducing vibrations caused by impact. Estwing hammers are the only hammers that can make this claim. The head and handles are fully polished and are forged in one piece.		
EWE3-2H	502188	HATCHET CARPENTERS NYLON - VINYL GRIP Overall Length: 13" / 330mm. Cutting Edge: 3.625" / 92mm	034139624219	
<b>PRY BARS &amp; NAIL PULLERS</b>				
<b>CONSTRUCTION</b>				
		Estwing's Lightweight I-Beam Construction Pry Bar has a beveled nail slot. It's I-Beam construction gives added strength while removing weight. Rocking head provides maximum leverage.		
EWPB-18	502219	BAR CONSTRUCTION 450MM LIGHT WEIGHT I-BEAM	034139650218	
<b>PRO-CLAW</b>				
		Truly a unique patented roofing, siding, contractor bar. Drop forged from fine tool steel, one end has a thin blade with a 2 1/2" fulcrum giving it a higher lift than other bars. For removing shingles, downpipes, gutters and nails with ease. The other end has a Japanese pattern nail puller with rounded head to improve leverage and pull even the most difficult nails.		
EWRSC	502225	PRO-CLAW ROOFING SIDING & CONSTRUCTION (RSC) BAR Overall Length: 16.8" / 426.7 mm - approx	034139104414	
<b>HANDY CLAW</b>				
		Estwing's Handy Claw is the best tool for getting under and removing nails, with a comfortable vinyl grip.		
EWHC-10	502212	CLAW HANDY VINYL GRIP 250MM	034139630012	
<b>HANDY BAR</b>				
		Estwing's 15" Handy Bar is forged half round, for added strength and less weight. Wide, thin blade for easy prying.		
EWHB-15	502211	BAR HANDY FORGED HALF ROUND 381MM Overall Length: 15" / 381 mm	034139640011	











PART NO.	ITEM	DESCRIPTION	BARCODE	IMAGE
<b>MOULDING PULLER</b>				
The 10" and 12" moulding puller is made of fine tool steel, drop forged and tempered for extra durability. Chrome finish and comfortable blue cushion grip. Precision thin blade for removing moulding without damaging the wall. Slot in blade for removing small nails and brads. Other end has popular Japanese nail puller with precise and sharp claws for removing embedded nails or headless nails with ease and minimal damage. Blade end for removing moulding precision claw allows finished nails to be pulled through moulding so the moulding can be reused.				
EWMP250G	502213	CLAW PRO MOULDING PULLER 250MM WITH CUSHION GRIP	034139104063	
EWMP300G	502214	CLAW PRO MOULDING PULLER 300MM WITH CUSHION GRIP	034139104261	
<b>NAIL PULLER</b>				
Estwing's Japanese pattern design Pro-Claw nail pullers are made with fine tool steel, drop forged and tempered for extra durability. Chrome finish and comfortable blue cushion grip. Both nail claws are precise and sharp to remove embedded or headless nails with ease and minimal wood damage. Shape and rounded head design gives you improved leverage. Precision thin claw design enables you to get into hard to reach places. For use in nail removal right angled for removing embedded and headless nails.				
EWPC210G	502220	NAIL PULLER 225MM PRO-CLAW WITH CUSHION GRIP	034139102762	
EWPC250G	502221	NAIL PULLER 250MM PRO-CLAW WITH CUSHION GRIP	034139102960	
EWPC280G	502222	NAIL PULLER 275MM PRO-CLAW WITH CUSHION GRIP	034139103264	
EWPC300G	502223	NAIL PULLER 300MM PRO-CLAW WITH CUSHION GRIP	034139103462	
EWPC360G	502224	NAIL PULLER 375MM PRO-CLAW WITH CUSHION GRIP	034139103868	
<b>WRECKING BAR</b>				
Estwing's gooseneck bars pull, pry and straighten, with an angled chisel on one end for prying and lifting, and the other end is slotted for pulling nails.				
EWEWB-12	502205	WRECKING BAR 12" / 304MM GOOSENECK	034139100010	
EWEWB-18	502206	WRECKING BAR 18" / 457MM GOOSENECK	034139100119	
EWEWB-24	502207	WRECKING BAR 24" / 610MM GOOSENECK	034139100218	
EWEWB-30	502208	WRECKING BAR 30" / 762MM GOOSENECK	034139100317	
EWEWB-36	502209	WRECKING BAR 36" / 900MM GOOSENECK	034139100416	
<b>GEOLOGICAL</b>				
<b>ROCK CHISEL</b>				
Estwing full assortment of rock chisels have vinyl grips				
EWERC-7C	502202	CHISEL ROCK 175MM VINYL GRIP Cut Point: 2.325" Stock: 0.625"	034139690115	
EWERC-9C	502204	CHISEL ROCK 225MM VINYL GRIP Cut Point: 0.75" Stock: 0.75"	034139690139	
EWERC-12C	502201	CHISEL ROCK 300MM VINYL GRIP Cut Point: 0.625" Stock: 0.375"	034139690146	
<b>PLASTIC GOLD PAN</b>				
Estwing's Plastic Gold Pans are rust proof, chemical resistant and light weight.				
EWBP-10	502157	GOLD PAN PLASTIC 5OZ 250MM Weight: 140g	034139860716	
EWBP-12	502158	GOLD PAN PLASTIC 6OZ 300MM Weight: 168g	034139860815	
EWBP-14	502159	GOLD PAN PLASTIC 9OZ 350MM Weight: 252g	034139861010	
EWBP-16	502160	GOLD PAN PLASTIC 13OZ 400MM Weight: 364g	034139861218	
<b>STEEL GOLD PAN</b>				
Estwing's Steel Gold Pans have creases for thorough separation and a lanyard hole for easy use and carrying.				
EW10-10	502145	GOLD PAN STEEL 8OZ 250MM Weight: 224g	034139860013	
EW12-12	502146	GOLD PAN STEEL 12OZ 300MM Weight: 336g	034139860211	
EW16-16	502147	GOLD PAN STEEL 28OZ 400MM Weight: 784g	034139860617	

PART NO.	ITEM	DESCRIPTION	BARCODE	IMAGE
<b>HAMMERS</b>				
<b>BALL PEIN</b>				
		<p>Nylon Vinyl Shock Reduction Grip®                      The Ball Pein Hammers have bonded and moulded Shock Reduction Grip® which offers the utmost in both comfort and durability, while reducing vibrations caused by impact. Estwing hammers are the only hammers that can make this claim. The head and handles are fully polished and are forged in one piece.</p>		
EWE3-16BP	502171	HAMMER BALL PEIN 16OZ VINYL GRIP Overall Length: 13" / 330 mm	034139623410	
EWE3-24BP	502182	HAMMER BALL PEIN 24OZ VINYL GRIP Overall Length: 13.5" / 343 mm	034139627814	
EWE3-32BP	502189	HAMMER BALL PEIN 32OZ VINYL GRIP Overall Length: 14.5" / 368 mm	034139629610	
<b>BRICKLAYER</b>				
		<p>Nylon Vinyl Shock Reduction Grip® with end cap.                      The Bricklayer's Hammers have bonded and moulded Shock Reduction Grips®. Patented super tough nylon end caps now makes these hammers the most durable on the market. The head and handles are forged in one piece and are fully polished. These tools have unsurpassed balance and are double tempered for added strength.</p>		
EWE3-20BLC	502173	HAMMER BRICKLAYERS 20OZ VINYL GRIP Overall Length: 11" / 279 mm	034139624516	
EWE3-24BLC	502181	HAMMER BRICKLAYERS 24OZ VINYL GRIP Overall Length: 11" / 279 mm	034139627715	
EWE6-22BLC	502196	<p>HAMMER BRICKLAYERS "BIG BLUE"                      Same as Bricklayer's Hammers except with a larger face and wider blade.                      Overall Length: 10" / 254 mm                      Head weight approx: 22oz / 616g</p>	034139627661	
<b>CHIPPING - WELDERS</b>				
		<p>Nylon Vinyl Shock Reduction Grip®                      The Welding Chipping Hammer has a bonded and moulded Shock Reduction Grip® which offers the utmost in both comfort and durability, while reducing vibrations caused by impact. Estwing hammers are the only hammers that can make this claim. The head and handle are forged in one piece and are fully polished.</p>		
EWE3-WC	502192	CHIPPING HAMMER WELDERS 14OZ VINYL GRIP Overall Length: 11" / 279 mm	034139621812	
<b>CLAW - LEATHER GRIP</b>				
		<p>Beautiful Leather Grip                      Estwing's Solid Steel Claw English Pattern Hammers provide unsurpassed balance and temper. The head and handle are forged in one piece.</p>		
EWE12C	502163	HAMMER CLAW 12OZ LEATHER GRIP Overall Length: 11" / 279 mm	034139610816	
EWE20C	502165	HAMMER CLAW 20OZ LEATHER GRIP Overall Length: 12.5" / 318 mm	034139612018	
EWE24C	502167	HAMMER CLAW 24OZ LEATHER GRIP Overall Length: 13.5" / 343 mm	034139612810	
		<p><b>ULTRA Claw Hammer - Leather Grip</b>                      Made in USA. Light weight, forged from single piece of steel and capable of driving nails faster. Designed with the professional in mind. An extra nail pulling notch built into the head for use in tight spots and a magnetic nail starter is built into the hammer head. World famous and patented Shock Reduction grip for added durability, reliability and comfort.</p>		 <div style="position: absolute; bottom: 10px; right: 10px; border: 1px solid black; border-radius: 50%; padding: 2px 5px; background-color: #0070C0; color: white; font-weight: bold;">NEW</div>
EWE15CR	511089	ULTRA 15oz Curved Claw Hammer, Black with leather grip, 15" handle	034139679202	

PART NO.	ITEM	DESCRIPTION	BARCODE	IMAGE
<b>CLAW - VINYL GRIP</b>				
Nylon Vinyl Shock Reduction Grip® Estwing's Curved Claw English Pattern Solid Steel Hammer provide unsurpassed balance and temper. The head and handle are fully polished and forged in one piece. Our exclusive Shock Reduction Grip® is moulded on and offers the utmost in both comfort and durability, while reducing vibrations caused by impact.				
EWE3-16C	502172	<b>HAMMER CLAW 16OZ VINYL GRIP</b> Overall Length: 13" / 330 mm	034139623618	
EWE3-20C	502174	<b>HAMMER CLAW 20OZ VINYL GRIP</b> Overall Length: 13.5" / 343 mm	034139624615	
EWE3-28C-24	502185	<b>HAMMER CLAW 24OZ VINYL GRIP</b> Overall Length: 13.5" / 343 mm	034139628415	
<b>CROSS PEIN</b>				
Nylon Vinyl Shock Reduction Grip® with patented end cap The Cross Pein hammers have a bonded and moulded Shock Reduction Grip®. The head and handle are forged in one piece and have an attractive blue UV coating. This tool has unsurpassed balance and temper.				
EWE6-40CP	502199	<b>HAMMER CROSS PEIN 40OZ</b> Overall Length: 14.25" / 362 mm	034139620341	
<b>DEAD BLOW</b>				
Vinyl Grip Estwing's Polyurethane Deadblow Hammers with vinyl grip have one piece hot cast polyurethane construction for longer life and more elasticity. No exposed metal on head or handle. The head contains hundreds of steel shot for maximum power and control. Comfortable vinyl grip for ease of use and reduces fatigue. Great for non-marring applications.				
EW22E	502148	<b>HAMMER POLY DEADBLOW 22OZ VINYL GRIP</b> Overall Length: 11.25" / 286 mm Head Length: 3.75" / 95 mm Face Diameter: 2.25" / 41 mm	034139312215	
EW45E	502151	<b>HAMMER POLY DEADBLOW 45OZ VINYL GRIP</b> Overall Length: 14.25" / 362 mm Head Length: 4.625" / 117 mm Face Diameter: 1.625" / 57 mm	034139312611	
<b>DRILLING (CLUB)</b>				
Nylon Vinyl Shock Reduction Grip® The Drilling Hammer has a bonded and moulded Shock Reduction Grip® which offers the utmost in both comfort and durability, while reducing vibrations caused by impact. The head and handle are forged in one piece and have an attractive blue UV coating, both faces are fully polished. For use with chisels, punches, star drills and hardened nails. Permits heavy blows with limited swing.				
EWB3-2LB	502153	<b>HAMMER DRILLING 2LB VINYL GRIP</b> Overall Length: 10.5" / 267 mm	034139620013	
EWB3-3LB	502154	<b>HAMMER DRILLING 3LB VINYL GRIP</b> Overall Length: 11" / 279 mm	034139620211	
EWB3-4LB	502155	<b>HAMMER DRILLING 4LB VINYL GRIP</b> Overall Length: 11.5" / 292 mm	034139620419	
EWB3-4LBL	502156	<b>HAMMER DRILLING 4LB VINYL GRIP LONG HANDLE</b> Overall Length: 16" / 406 mm	034139620617	

PART NO.	ITEM	DESCRIPTION	BARCODE	IMAGE
<b>DRYWALL</b>				
		Nylon Vinyl Shock Reduction Grip® The Drywall hammer has a bonded and moulded Shock Reduction Grip® which offers the utmost in both comfort and durability, while reducing vibrations caused by impact. Estwing hammers are the only hammers that can make this claim. The head and handle are forged in one piece and are fully polished. The round face makes for easy nail driving and the blade will score drywall.		
EWE3-11	502169	<b>HAMMER DRYWALL 11OZ VINYL GRIP</b> Overall Length: 13.5" / 343 mm	034139622215	
				
<b>ENGINEER'S</b>				
		Nylon Vinyl Shock Reduction Grip® with patented end cap. The Engineer's Hammer has a bonded and moulded Shock Reduction Grip® which offers the utmost in both comfort and durability, while reducing vibrations caused by impact. Estwing hammers are the only hammers that can make this claim. The head and handle are forged in one piece. This tool has unsurpassed balance and temper.		
EWE6-48E	502200	<b>HAMMER ENGINEERS 48OZ / 1.344kg</b> Overall Length: 16" / 406 mm	034139620310	
<b>FRAMING</b>				
		Nylon Vinyl Shock Reduction Grip® Estwing's Solid Steel Framing Hammer has a longer handle for more striking power. The head and handle are fully polished and forged in one piece. Our exclusive Shock Reduction Grip® is moulded on and offers the utmost in both comfort and durability, while reducing vibrations caused by impact.		  
EWE3-22S	502178	<b>HAMMER FRAMING 22OZ VINYL GRIP, Smooth Face</b> Overall Length: 16" / 406 mm	034139626411	
EWE3-22SM	502179	<b>HAMMER FRAMING 22OZ MILLED FACE VINYL GRIP</b> Overall Length: 16" / 406 mm	034139626619	
EWE3-28S	502186	<b>HAMMER FRAMING 28OZ VINYL GRIP, Smooth face</b> Overall Length: 16" / 406 mm	034139628811	
EWE3-28SM	502187	<b>HAMMER FRAMING 28OZ MILLED VINYL GRIP</b> Overall Length: 16" / 406 mm	034139629016	

PART NO.	ITEM	DESCRIPTION	BARCODE	IMAGE
EWE3-25S	502184	"BIG BLUE" Builder Series - Smooth Face HAMMER FRAMING 25OZ LARGE FACE VINYL GRIP Overall Length: 18" / 457 mm	034139628262	
<b>ULTRA Framing Hammers</b> Made in USA. Light weight, forged from single piece of steel and capable of driving nails faster. Designed with the professional in mind. An extra nail pulling notch built into the head for use in tight spots and a magnetic nail starter is built into the hammer head. World famous and patented Shock Reduction grip for added durability, reliability and comfort.				
EWE15C	511123	HAMMER, ULTRA 15oz Curved Claw Framing Hammer, Black with leather grip 19" Handle	034139679219	
EWE19S	511124	HAMMER, ULTRA 19oz Straight Claw Framing Hammer, Black with leather grip 19" Handle	034139679120	
<b>HAMMERTOOTH</b>				
<p>Nylon Vinyl Shock Reduction Grip® Estwing's Patented Hammertooth® Hammers are great for straightening all 2x boards. The head and handle are forged in one piece. Our exclusive Shock Reduction Grip® is moulded on and offers the utmost in both comfort and durability, while reducing vibrations caused by impact.</p> <p><b>HAMMERTOOTH®</b></p>    <p>• Great for straightening all 2x boards. • Makes work with pneumatic nailers quick and safer. • With our patented Shock Reduction Grip. • Forged in one piece</p> <p><b>Grab and Straighten!</b> Straighten warped or twisted boards by securing 2x timber between the tooth and the claw of the Hammertooth and twisting. Hold the timber in position until it is nailed.</p>				
EWE6-22T	502197	HAMMER HAMMERTOOTH 22OZ, Smooth Face Overall Length: 13.5" / 343 mm	034139627111	
EWE6-22TM	502198	HAMMER HAMMERTOOTH 22OZ - MILLED FACE Overall Length: 13.5" / 343 mm	034139626916	
<b>RIP</b>				
<p>Nylon Vinyl Shock Reduction Grip® Estwing's Rip Claw Solid Steel Hammer provide unsurpassed balance and temper. The head and handle are fully polished and forged in one piece. Our exclusive Shock Reduction Grip® is moulded on and offers the utmost in both comfort and durability, while reducing vibrations caused by impact.</p>				
EWE3-20S	502176	HAMMER RIP 20OZ Overall Length: 13.5" / 343 mm	034139625018	
<b>SLEDGE</b>				
EWSHF12LB	511093	12LB/5.5KG Sledge Hammer, 915mm Handle with Extra-thick Fibreglass Core	034139313267	

PART NO.	ITEM	DESCRIPTION	BARCODE	IMAGE
<b>ROCK PICKS</b>				
<b>CHISEL EDGE</b>				
		Nylon Vinyl Shock Reduction Grip® with end cap. The Chisel Edge Rock Pick have bonded and moulded Shock Reduction Grips®. Patented nylon end caps now makes these hammers the most durable on the market. The head and handles are forged in one piece and are fully polished. These tools have unsurpassed balance and are double tempered for added strength.		
EWE3-20BLC	502173	HAMMER BRICKLAYERS 20OZ VINYL GRIP Overall Length: 11" / 279 mm	034139624516	
EWE3-24BLC	502181	HAMMER BRICKLAYERS 24OZ VINYL GRIP Overall Length: 11" / 279 mm	034139627715	
<b>GEO PALEO</b>				
		Vinyl Cushion Grip Estwing's all Steel Construction Geo/Paleo Pick has a 25" overall handle length, 14" overall head length from pointed edge to chisel edge. Has a durable powder coated finish and a textured vinyl grip for added comfort		
EWGP100	502210	PICK GEO PALEO Overall Length: 25" / 625 mm	034139784913	
<b>POINTED TIP</b>				
		Nylon Vinyl Shock Reduction Grip® Estwing Rock Picks have bonded and moulded Shock Reduction Grip® which offers the utmost in both comfort and durability, while reducing vibrations caused by impact. The head and handle are forged in one piece and have a fully polished head. The #1 choice of geologist world wide.		
EWE3-14P	502170	ROCK PICK 14OZ POINTED TIP VINYL GRIP Overall Length: 11" / 279 mm	034139623212	
EWE3-22P	502177	ROCK PICK 22OZ POINTED TIP VINYL GRIP Overall Length: 13" / 330 mm	034139626213	
EWE3-23LP	502180	ROCK PICK 22OZ POINTED TIP VINYL GRIP - LONG HANDLE Overall Length: 16.5" / 419 mm	034139627210	
EWE30	502168	ROCK PICK 22OZ POINTED TIP LEATHER TIP World famous Estwing leather grip rock pick with beautiful leather grip. Overall Length: 12.5" / 318 mm	034139613817	
EW3	502149	SHEATH LEATHER REPLACEMENT SUITS POINTED TIP PICKS Genuine Leather.	034139810414	
EW4	502150	SHEATH LEATHER REPLACEMENT SUITS CHISEL EDGE PICKS Genuine Leather.	034139810612	
<b>SURE SPLIT WEDGE</b>				
		This unique 5 lb wedge has a revolutionary concept in design which makes splitting wood fast and easy. This wedge has a fast taper head for easy starting. The Sure Split® fins permit extra wedge action and the sledge will continue through out below the wood line for sure splitting.		
EWE-5	502195	SURE SPLIT WEDGE Overall Length: 9" / 229 mm Cutting Edge: 1 7/8" / 48 mm	034139740018	



# *THOR HAMMER*

Established in the 1930s, Thor has specialised in the manufacture of soft faced hammers and soft impact hammers for over 75 years.







Originally buffalo hide (rawhide) was the only material used for 'soft' striking faces, but Thor now manufacture over 300 types and sizes using a range of materials including copper, brass, aluminium, rubber, hardwood, nylon and a range of plastics.









PART NO.	ITEM	DESCRIPTION	BARCODE	IMAGE
<b>HAMMERS</b>				
<b>RAWHIDE HAMMER</b>				
<p>Malleable Iron head fitted with cylindrical faces of compressed Rawhide. The Malleable Iron head provides the weight for the blow and the Rawhide faces absorb the shock whilst transferring the force to the item being struck without fear of damage. Ideal where a heavy blow is required combined with a relatively small striking area. Faces are designed to wear and can be replaced. Used as a general-purpose soft-faced hammer in engineering for assembly, repair and maintenance.</p>				
TH08	508896	RAWHIDE HAMMER SIZE A, 285g, 3/4lb, 25mm FACE	5012936000806	
TH10	508898	RAWHIDE HAMMER SIZE 1, 590g, 1 1/4lb, 32mm FACE	5012936001001	
TH12	508906	RAWHIDE HAMMER SIZE 2, 800g, 1 3/4lb, 38mm FACE	5012936001209	
TH14	508911	RAWHIDE HAMMER SIZE 3, 1230g, 2 3/4lb 44mm FACE	5012936001407	
TH16	508915	RAWHIDE HAMMER SIZE 4, 1900g, 4 1/4lb 50mm FACE	5012936001605	
TH22	508929	RAWHIDE HAMMER SIZE 5, 3275g, 7 1/4lb, 70mm FACE	5012936002206	
TH16FG	508917	RAWHIDE HAMMER SIZE 4, 2000g, 4 1/2lb, 50mm FACE F/GLASS HANDLE	5012936001647	 <span style="color: blue; font-weight: bold; border: 1px solid blue; border-radius: 50%; padding: 2px;">NEW</span>
<b>COPPER FACED HAMMER</b>				
<p>Malleable Iron head fitted with cylindrical faces of Copper. The Malleable Iron head and the Copper faces combine to provide the weight for the blow and the Copper faces prevent damage to expensive machined sub components and assemblies. Ideal where a heavy blow is required combined with a relatively small striking area. Faces are designed to wear and can be replaced. Used as a general-purpose soft-faced hammer in automotive and general engineering for assembly, repair and maintenance.</p>				
TH308	508934	COPPER HAMMER SIZE A, 425g, 1lb, 25mm FACE	5012936030803	
TH310	508936	COPPER HAMMER SIZE 1, 830g, 2lb, 32mm FACE	5012936031008	
TH312	508938	COPPER HAMMER SIZE 2, 1260g, 2 3/4lb, 38mm FACE	5012936031206	
TH314	508941	COPPER HAMMER SIZE 3, 1940g, 4lb, 44mm FACE	5012936031404	
TH316	508943	COPPER HAMMER SIZE 4, 2830g, 6 1/4lb, 50mm FACE	5012936031602	
TH322	508949	COPPER HAMMER SIZE 5, 6000g 13lb, 70mm FACE	5012936032203	
TH316FG	508945	COPPER HAMMER SIZE 4, 2930g, 7lb, FIBREGLASS HANDLE, 50mm FACE	5012936631604	 <span style="color: blue; font-weight: bold; border: 1px solid blue; border-radius: 50%; padding: 2px;">NEW</span>
<b>COPPER / RAWHIDE HAMMER</b>				
<p>Malleable Iron head fitted with one Rawhide and one Copper cylindrical face. The malleable Iron head and the Copper/Rawhide faces combine to provide the weight for the blow and the faces prevent damage to most items being struck. Ideal where a heavy blow is required combined with a relatively small striking area. Faces are designed to wear and can be replaced. Used as a multi purpose soft faced hammer in engineering and automotive for assembly, repair and maintenance.</p>				
TH208	508923	COPPER/RAWHIDE HAMMER SIZE A, 355g, 3/4lb, 25mm FACE	5012936020804	
TH210	508924	COPPER/RAWHIDE HAMMER SIZE 1, 710g, 1.1/2lb 32mm FACE	5012936021009	
TH212	508925	COPPER/RAWHIDE HAMMER SIZE 2, 1070g, 2.1/2lb 38mm FACE	5012936021207	
TH214	508926	COPPER/RAWHIDE HAMMER SIZE 3, 1600g, 3.1/2lb 44mm FACE	5012936021405	
TH216	508927	COPPER/RAWHIDE HAMMER SIZE 4, 2830g 5.1/4lb 50mm FACE	5012936021603	
TH216FG	508928	COPPER/RAWHIDE HAMMER SIZE 4, 2480g, 5 1/2lb, FIBREGLASS HANDLE, 50mm FACE		



PART NO.	ITEM	DESCRIPTION	BARCODE	IMAGE
<b>NYLON HAMMER</b>				
Chrome plated Zinc heads (except 720) with Nylon faces. Fitted as standard with screw-in White Nylon faces and Plastic or Wood handle according to size . Alternative Replacement Faces, colour coded to distinguish hardness are also available as buy-in items. Faces are designed to wear and are replaceable by hand. Used, due to the easily interchangeable heads, as a multi purpose striking tool in most assembly applications including engineering, furniture, shopfitting, partitioning, double glazing, injection moulding dies etc.				
TH710	508974	NYLON HAMMER 445g, 1lb, 32mm FACE PLASTIC HANDLE	5012936117108	
TH712	508979	NYLON HAMMER 650g, 1 1/2lb, 38mm FACE PLASTIC HANDLE	5012936117122	
TH714	508984	NYLON HAMMER 850g, 2lb, 44mm FACE PLASTIC HANDLE	5012936117146	
TH716	508988	NYLON HAMMER 1230g, 2 3/4lb, 50mm FACE PLASTIC HANDLE	5012936117160	
TH708	508971	NYLON HAMMER 250g, 1/2lb, 25mm FACE WOOD HANDLE	5012936570804	
TH720	508993	NYLON HAMMER 2200g, 5lb, 63mm FACE WOOD HANDLE	5012936127206	
TH720FG	508994	NYLON HAMMER 2300g, 5 1/4lb, 63MmmFACE, F/GLASS HANDLE	5012936427207	
<b>DEAD-BLOW HAMMER</b>				
THE IDEAL HAMMER FOR SUSTAINED AND EFFECTIVE BLOWS WITHOUT RECOIL Coated Die-cast aluminium alloy head rubber grip, fitted with screw-in white nylon faces, or for certain specialist applications, tough brown Polyurethane faces are also available. A cavity inside the head is partially filled with steel shot which adds to the weight, prevents rebound and delivers "dead" blows of maximum impact. The faces are designed to wear and are easily replaceable by hand. Commonly used in most assembly / fitting applications including engineering, toolmaking, shop fitting, partitioning, glazing etc.				
TH1212N	508908	DEAD-BLOW HAMMER 700g, 1 1/2lb 38mm WHITE FACE	5012936121211	
TH1414N	508912	DEAD-BLOW HAMMER, 900g, 2lb 44mm WHITE FACE	5012936141417	
TH1616N	508916	DEAD-BLOW HAMMER 1150g, 2 3/4lb 50mm WHITE FACE	5012936161613	
TH2020N	508921	DEAD-BLOW HAMMER 1850g, 4lb 63mm WHITE FACE	5012936202019	
<b>THOREX HAMMER</b>				
Chrome plated Zinc heads with one White Nylon face and one Soft Grey face fitted as standard. Alternative replacement faces, colour coded to distinguish hardness are also available. Faces are designed to wear and are replaceable by hand. Used, due to the easily interchangeable heads, as a multi purpose striking tool in most DIY applications. Can also be used in engineering, furniture assembly, shopfitting, partitioning, double glazing, injection moulding dies etc.				
TH31708R	508946	THOREX HAMMER, 250g, 1/2lb, 25mm FACE	5012936070854	
TH31710R	508947	THOREX HAMMER, 415g, 1lb, 32mm FACE	5012936071004	
TH31712R	508948	THOREX HAMMER 650g, 1 1/2lb 38mm FACE	5012936061202	
<b>THOREX PLASTIC HAMMER</b>				
Thorex Plastic Hammer with chrome plated Zinc head and plastic or wood handles according to size. Fitted as standard with two screw-in Orange Plastic faces. Alternative Soft Grey or Hard yellow are available as buy-in items. Product 414 & 416 are only available with Orange Plastic Faces. Faces are designed to wear and are replaceable by hand. Used, due to the easily interchangeable heads, as a multi purpose striking tool in most assembly applications including engineering, furniture, shopfitting, partitioning, double glazing, injection moulding dies etc. Standard sizes 406 and 408 have wooden handles; other sizes have plastic handles.				
TH406	508953	THOREX PLASTIC HAMMER, 150g, 1/3lb, 19mm FACE, Wood Handle	5012936040604	
TH408	508955	THOREX PLASTIC HAMMER, 250g, 1/2lb, 25mm FACE, Wood Handle	5012936040802	
TH410	508957	THOREX PLASTIC HAMMER, 450g, 1lb, 32mm FACE, Plastic Handle	5012936141004	
TH412	508959	THOREX PLASTIC HAMMER, 675g, 1 1/2lb, 38mm FACE, Plastic Hnd.	5012936141202	
TH414	508961	THOREX PLASTIC HAMMER, 900g, 2lb, 44mm FACE, Plastic Handle	5012936141400	
TH416	508963	THOREX PLASTIC HAMMER, 1250g, 2 3/4lb, 50mm FACE, Plastic	5012936141608	

PART NO.	ITEM	DESCRIPTION	BARCODE	IMAGE
<b>JUNIOR THORLITE HAMMER</b>				
Aluminium-alloy head fitted with one hard Rubber and one soft red tipped Rubber face. The Aluminium-alloy head together with the hard and soft Rubber faces provide a lightweight hammer with faces of differing hardness. Faces are designed to wear and are replaceable. Specifically designed for use on woodwork, easing tight doors/windows trim fitting including chrome and rubber surrounds and for light assembly work				
TH32J612R	508951	JUNIOR THORLITE HAMMER, 320g, 3/4lb, 38mm FACE	5012936061296	
<b>MALLETS</b>				
<b>SOLID COPPER MALLET / SLEDGES - FIBREGLASS HANDLE</b>				
Manufactured from 99.9% Pure Extruded Electrolytic Copper rod. The Cylindrical Copper heads provide a firm positive blow without the risk of damage to expensive components. These larger sizes only available with Fibreglass (FG) handles. Ideal for positive blows on highly finished or closely ground machined parts throughout the aircraft, automotive and shipping industries. Also used by bearing assembly in heavy industrial applications such as earthmoving equipment, shipping, mining etc.				
TH711FG	508978	SOLID COPPER MALLET 70MM X 146MM, 5.2KG, 11 1/2lb	5012936571153	
TH713FG	508983	SOLID COPPER MALLET 70MM X 181MM, 5.7KG, 12 1/2lb	5012936571351	
TH715FG	508987	SOLID COPPER MALLET 70MM X 197MM, 7.5KG, 16 1/2lb	5012936571559	
TH717FG	508991	SOLID COPPER MALLET 70MM X 225MM, 8.5KG, 18 3/4lb	5012936571757	
TH719FG	508992	SOLID COPPER MALLET 85MM X 173MM, 9.0KG, 20lb	5012936571955	
<b>SOLID COPPER MALLET - PLASTIC HANDLE</b>				
Manufactured from 99.9% Pure Extruded Electrolytic Copper rod. The Cylindrical Copper heads provide a firm positive blow without the risk of damage to expensive components. Fitted with a Plastic handle. Ideal for positive blows on highly finished or closely ground machined parts throughout the aircraft, automotive and shipping industries. Also used by tool and gauge makers and for bearing assembly in heavy industrial applications such as earthmoving equipment, shipping, etc.				
TH704	508968	SOLID COPPER MALLET, 950g, 2lb 38mm FACE	5012936570415	
TH705	508969	SOLID COPPER MALLET, 1330g, 3lb, 44mm FACE	5012936570514	
TH706	508970	SOLID COPPER MALLET, 1780g, 4lb, 50mm FACE	5012936570613	
<b>RAWHIDE MALLET</b>				
Cylindrical compressed Rawhide head provides a large striking surface with relatively light head weight. Used in sheet metal forming, jewellery industry and assembling steel rule dies in cutter plattens.				
TH108	508900	RAWHIDE MALLET SIZE 0, 90g, 2oz, 25mm FACE	5012936010805	
TH110	508902	RAWHIDE MALLET SIZE 1, 130g, 4oz, 32mm FACE	5012936011000	
TH112	508903	RAWHIDE MALLET SIZE 2, 190g, 6oz, 38mm FACE	5012936011208	
TH114	508904	RAWHIDE MALLET SIZE 3, 250g, 1/2lb, 44mm FACE	5012936011406	
TH116	508905	RAWHIDE MALLET SIZE 4, 340g, 3/4lb, 50mm FACE	5012936011604	
TH120	508907	RAWHIDE MALLET SIZE 5, 570g, 1 1/4lb, 63mm FACE	5012936012007	
<b>RUBBER MALLET</b>				
One-piece rubber head with self locking handle. The rubber head enables a gentle but firm blow with little rebound. Used as a general-purpose mallet in automotive, industrial, brewery, DIY, camping etc. A softer black head is available from THOR but not stocked locally.				
TH952	508997	BLACK MALLET, 310g, 3/4lb WOOD HANDLE	5012936095208	
TH953	509001	BLACK MALLET, 550g, 1 1/4lb, WOOD HANDLE	5012936095307	
TH954	509005	BLACK MALLET, 800g 1 3/4lb, WOOD HANDLE	5012936095406	
TH957	509009	BLACK MALLET, 1200g, 2 3/4lb, WOOD HANDLE	5012936095703	
One-piece rubber head with self locking handle. The white rubber head enables a gentle but firm blow with little rebound. The white head will not leave marks on work surfaces and is ideal for woodworking, builders, window frame manufacturers, shopfitting, car trim fitting, DIY etc. Larger sizes also available with Fibreglass (FG) handles.				
TH952W	508999	WHITE MALLET, 375g, 3/4lb WOOD HANDLE	5012936095291	
TH953W	509003	WHITE MALLET, 675g, 1 1/2lb, WOOD HANDLE	5012936095390	
TH954W	509007	WHITE MALLET, 970g 2lb, WOOD HANDLE	5012936095499	
TH957W	509011	WHITE MALLET, 1450g, 3lb, WOOD HANDLE	5012936095796	

PART NO.	ITEM	DESCRIPTION	BARCODE	IMAGE
<p>One-piece rubber head with self locking Fibreglass (FG) handle. The rubber head enables a gentle but firm blow with little rebound. Used as a general-purpose mallet in automotive, industrial, brewery, DIY, camping etc. A softer black head is available for use where softer blows are required. .</p>				
TH952FG	508998	BLACK MALLET, 380g, 3/4lb, FIBREGLASS HANDLE	5012936595203	
TH953FG	509002	BLACK MALLET, 640g, 1 1/2lb, FIBREGLASS HANDLE	5012936595302	
TH954FG	509006	BLACK MALLET , 900g, 2lb, FIBREGLASS HANDLE	5012936595401	
TH957FG	509010	BLACK MALLET, 1300g, 3lb, FIBREGLASS HANDLE	5012936595708	
<p>One-piece rubber head with self locking Fibreglass (FG) handle. The white rubber head enables a gentle but firm blow with little rebound. The white head will not leave marks on work surfaces and is ideal for woodworking, builders, window frame manufacturers, shopfitting, car trim fitting, DIY etc.</p>				
TH952WFG	509000	WHITE MALLET, 445g, 1lb, FIBREGLASS HANDLE	5012936595296	
TH953WFG	509004	WHITE MALLET, 765g, 1 3/4lb, FIBREGLASS HANDLE	5012936595395	
TH954WFG	509008	WHITE MALLET, 1070g, 2 1/4lb, FIBREGLASS HANDLE	5012936595494	
TH957WFG	509012	WHITE MALLET, 1550g, 3 1/4lb, FIBREGLASS HANDLE	5012936595791	
<b>HAMMER SPARES</b>				
<b>COPPER FACE</b>				
TH312AF	508939	ALUMINIUM FACE HAMMER SPARE 38MM SUIT TH312	5012936723125	
TH308C	508935	COPPER FACE HAMMER SPARE 25MM SUITS TH308 & TH208	5012936713089	
TH310C	508937	COPPER FACE HAMMER SPARE 32MM SUITS TH310 & TH210	9313540110209	
TH312C	508940	COPPER FACE HAMMER SPARE 38MM SUITS TH312 & TH212	5012936713126	
TH314C	508942	COPPER FACE HAMMER SPARE 44MM SUITS TH314 & TH214	5012936713140	
TH316C	508944	COPPER FACE HAMMER SPARE 50MM SUITS TH316 & TH216	5012936713164	
TH322C	508950	COPPER FACE HAMMER SPARE 70MM SUITS TH322	5012936713225	
<b>NYLON FACE</b>				
TH708NF	508972	NYLON FACE HAMMER SPARE 25MM WHITE SUITS TH708	5012936670818	
TH710NF	508975	NYLON FACE HAMMER SPARE 32MM WHITE SUITS TH710 (Pack of 2)	5012936071028	
TH712NF	508980	NYLON FACE HAMMER SPARE 38MM WHITE SUITS TH712 & TH1212N (Pack of 2)	5012936071226	
TH714NF	508985	NYLON FACE HAMMER SPARE 44MM WHITE SUITS TH714 & TH1414N	5012936671419	
TH716NF	508989	NYLON FACE HAMMER SPARE 50MM WHITE SUITS TH716 & TH1616N	5012936671617	
TH720NF	508995	NYLON FACE HAMMER SPARE 63MM WHITE SUITS TH720 & TH2020N	5012936672010	
<b>PLASTIC FACE</b>				
TH406PF	508954	PLASTIC FACE HAMMER SPARE 19MM SUITS TH406	5012936340636	
TH408PF	508956	PLASTIC FACE HAMMER SPARE 25MM SUITS TH408	5012936340834	
TH410PF	508958	PLASTIC FACE HAMMER SPARE 32MM SUITS TH410	5012936341039	
TH412PF	508960	PLASTIC FACE HAMMER SPARE 38MM SUITS TH412	5012936341237	
TH414PF	508962	PLASTIC FACE HAMMER SPARE 44MM SUITS TH414	5012936341435	
TH416PF	508964	PLASTIC FACE HAMMER SPARE 50MM SUITS TH416	5012936341633	

PART NO.	ITEM	DESCRIPTION	BARCODE	IMAGE
TH710VF	508977	PLASTIC FACE HAMMER SPARE 32MM SOFT(GREY) suits TH710	5012936671051	
TH712VF	508982	PLASTIC FACE HAMMER SPARE 38MM SOFT(GREY) SUITS TH712	5012936671259	
<b>POLYURETHANE FACE</b>				
TH708TF	508973	POLYURETHANE FACE HAMMER SPARE 25MM BROWN SUITS TH708	5012936670894	
TH710TF	508976	POLYURETHANE FACE HAMMER SPARE 32MM BROWN SUITS TH710	5012936671099	
TH712TF	508981	POLYURETHANE FACE HAMMER SPARE 38MM BROWN SUITS TH712 & TH1212N	5012936671297	
TH714TF	508986	POLYURETHANE FACE HAMMER SPARE 44MM BROWN SUITS TH714 & TH1414N	5012936671495	
TH716TF	508990	POLYURETHANE FACE HAMMER SPARE 50MM BROWN SUITS TH716 & TH1616N	5012936671693	
TH720TF	508996	POLYURETHANE FACE HAMMER SPARE 63MM BROWN SUITS TH720 & TH2020N	5012936672096	
<b>RAWHIDE FACE</b>				
TH08R	508897	RAWHIDE FACE HAMMER SPARE 25MM SUIT TH08 & TH208	5012936700805	
TH10R	508901	RAWHIDE FACE HAMMER SPARE 32MM T/S TH10 & TH210 (PACK OF 2)	5012936701000	
TH12R	508910	RAWHIDE FACE HAMMER SPARE 38MM SUITS TH12 & TH212	5012936701208	
TH14R	508913	RAWHIDE FACE HAMMER SPARE 44MM SUITS TH14 & TH214	5012936701406	
TH16R	508918	RAWHIDE FACE HAMMER SPARE 50MM SUITS TH16 & TH216	5012936701604	
TH22R	508930	RAWHIDE FACE HAMMER SPARE 70MM SUITS TH22	5012936702205	
<b>THORLITE FACE</b>				
TH612HF	508965	JNR THORLITE HAMMER SPARE 38MM HARD RUBBER (BLACK)	5012936561215	
TH612SF	508966	JNR THORLITE HAMMER SPARE 38MM SOFT RUBBER (RED)	5012936561222	
<b>HANDLES</b>				
THH1W	509014	WOODEN HANDLE NO 1 SUITS TH10,TH210 & TH310	9313540111077	
THH2W	509015	WOODEN HANDLE NO 2 SUITS TH212 & TH312	9313540111084	
THH3W	509016	WOODEN HANDLE NO 3 SUITS TH214 & TH314	9313540111091	
THH957W	509017	WOODEN HANDLE NO 4 SUITS TH957 RUBBER MALLET		
THH4W	509018	WOODEN HANDLE NO 4 SUITS 16/216/316/720	9313540111107	
THH953W	509019^	WOODEN HANDLE SUITS TH953 RUBBER MALLET		
THH954W	509020^	WOODEN HANDLE SUITS TH954 RUBBER MALLET		
THHAW	509022^	WOODEN HANDLE NO A SUITS TH08,TH208 & TH308	9313540111060	

# SANDO

Sando hammers were developed for use in the underground mines in South Africa to eliminate the possibility of breakage and enhance safety during use – they are almost indestructible!

The handle design is unique, using high tensile steel pins running the length of the handle through the eye of the hammer head. The steel pins are then encased in a shock-absorbing outer rubber shell with a steel lock-plate fitted in the hammer's head to ensure it can't come off.

SANDO

**UNBREAKABLE™ Rubber-Handled Striking Tools**

**SANDO**  
UNBREAKABLE STRIKING TOOLS

**ANSI**  
BS876  
ISO 15601

**FORGED HEAD**

- Superior grain structure
- Striking faces hardened to 50 - 58 HRC

**HIGH VISIBILITY HEAD**

- Instant identification

**ERGONOMIC SHAPE**

- Handle is shaped to provide a comfortable and safe grip

**LOCKED-IN LANYARD HOLE**

- Totally safe attachment

**IMPACT-ABSORBING HANDLE**

- Heavy duty rubber cushions impact, reducing fatigue and injury

**HIGH TENSILE STEEL RODS**

- High strength rubber-to-metal bonding makes the handle unbreakable

**NON-SLIP GRIP**

- Secure grip in both wet and dry conditions





**THICKENED BOSS**

- Further protects the hammer against overstrikes

**POSITIVE LOCKING PLATE**

- Head will not separate from the handle

**Safety  
Reliability  
Efficiency**

PART NO.	ITEM	DESCRIPTION	BARCODE	IMAGE	
<b>HAMMERS</b>					
Sando Hammers. 4-full handle length steel pins used for 900g, 1.4kg and 1.8kg hammers with 6-steel pins used for hammers 3.6kg and heavier. The steel pins are encased in a moulded rubber handle with positive locking of handle into head eliminating danger of head breaking away. Impact absorbing handle with moulded grip that is resistant to most industrial chemicals.					
<b>BALL PEIN</b>					
SDBP/2-14	507897	HAMMER BALL PEIN 32oz / 900g SANDO HANDLE Positive locking of handle into head eliminates danger of head breaking away. Impact absorbing handle. Moulded grip. Chemically resistant to most industrial chemicals.	6005730000522		
<b>CLUB</b>					
SDCLUB/2-12	507898	CLUB HAMMER 2lb/900g SANDO HANDLE	6005730000577		
SDCLUB/4-12	507899	CLUB HAMMER 4lb/1.8kg SANDO HANDLE	6005730000584		
<b>SLEDGE</b>					
SDSLDG/4-24	507911	SLEDGE HAMMER 4lb / 1.8kg WITH 24" HANDLE			
SDSLDG/8-24	507912	SLEDGE HAMMER 8lb / 3.6kg WITH 24" HANDLE	6005730000607		
SDSLDG/8-30	507914	SLEDGE HAMMER 8lb / 3.6kg WITH 30" HANDLE	6005730000614		
SDSLDG/10-30	507906	SLEDGE HAMMER 10lb / 4.5kg WITH 30" HANDLE	6005730000621		
SDSLDG/12-30	507908	SLEDGE HAMMER 12lb 5.5kg WITH 30" HANDLE	6005730000638		
SDSLDG/14-30	507909	SLEDGE HAMMER 14lb / 6.3kg WITH 30" HANDLE	6005730000645		
<b>SLEDGE - SOFT FACE</b>					
SDSLDG/4-12SF	510880	SLEDGE HAMMER SOFT FACE 4lb / 1.8kg WITH 12" HANDLE			
SDSLDG/8-24SF	510878	SLEDGE HAMMER SOFT FACE 8lb / 3.6kg WITH 24" HANDLE			
SDSLDG/8-30SF	510879	SLEDGE HAMMER SOFT FACE 8lb / 3.6kg WITH 30" HANDLE			
SDSLDG/10-30SF	510881	SLEDGE HAMMER SOFT FACE 10lb / 4.5kg WITH 30" HANDLE			
SDSLDG/12-30SF	510882	SLEDGE HAMMER SOFT FACE 12lb / 5.5kg WITH 30" HANDLE			
SDSLDG/14-30SF	510883	SLEDGE HAMMER SOFT FACE 14lb / 6.3kg WITH 30" HANDLE			
<b>SLEDGE - COPPER</b>					
SDSLDG/3-12C	510884	SLEDGE HAMMER COPPER 3lb / 1.4kg WITH 12" HANDLE			
SDSLDG/4-12C	510885	SLEDGE HAMMER COPPER 4lb / 1.8kg WITH 12" HANDLE			
SDSLDG/8-24C	510887	SLEDGE HAMMER COPPER 8lb / 3.6kg WITH 24" HANDLE			
SDSLDG/8-30C	510886	SLEDGE HAMMER COPPER 8lb / 3.6kg WITH 30" HANDLE			
SDSLDG/14-30C	510888	SLEDGE HAMMER COPPER 14lb / 6.3kg WITH 30" HANDLE			
<b>HANDLES</b>					
SDHNDL/12	507900	HANDLE SANDO 12" - 2lb/4lb CLUB			
SDHNDL/30-60	507904	HANDLE SANDO 30" - 10lb/12lb/14lb			

# **FALCON**

Made by







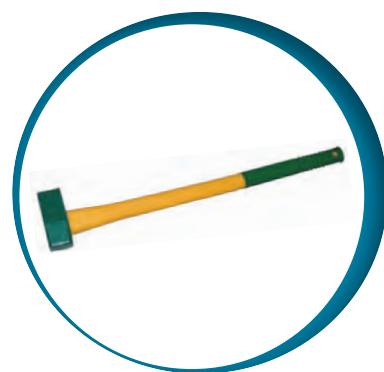



Produced by Lasher Tools, South Africa.



The Sure Grip Falcon sledge hammers are virtually indestructible with a solid steel core encased in a polypropylene outer shell and nonslip cushioned grip.

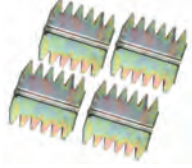

PART NO.	ITEM	DESCRIPTION	BARCODE	IMAGE	
<b>HAMMER</b>					
<b>BALL PEIN</b>					
Designed for driving cold chisels, punches, and for riveting, shaping and straightening metal, and peining the end of metal tubes. Nylon core handle with polypropylene shaft. Polyurethane bonded handle and head. Suregrip high comfort handle.					
FLB500N	502320	HAMMER BALL PEIN 500G/18oz, NYLON CORE HANDLE Overall Length: 300 mm	9313540200672		
FLB700N	502321	HAMMER BALL PEIN 700G/24oz, NYLON CORE HANDLE Overall Length: 350 mm	9313540200689		
FLB900N	502322	HAMMER BALL PEIN 900G/32oz, NYLON CORE HANDLE Overall Length: 350 mm	9313540200696		
FLB1.1N	502319	HAMMER BALL PEIN 1.1KG/40oz, NYLON CORE HANDLE Overall Length: 350 mm	9313540200832		
<b>MALLET</b>					
FLRM32	502375	RUBBER MALLET 32OZ FIBREGLASS HANDLE	9313540201532		
<b>CHIPPING HAMMER</b>					
FLCH	502338	<b>CHIPPING HAMMER - WELDERS</b> Chipping hammers have a forged head welded to a steel shaft with a shock proof spring handle. Used extensively for chipping scale after welding. Epoxy powder coated finish. Overall Length: 290 mm	9313540200467		
<b>BRICK</b>					
FLBH	502325	<b>BRICK HAMMER 800GM TIMBER HANDLE</b> Designed for splitting bricks, masonry, tile and concrete blocks Overall Length: 265 mm	9313540200450		
<b>CLUB</b>					
FLC1.8N	502336	<b>CLUB HAMMER 1.8KG/4LB 240MM NYLON CORE HANDLE</b> Heavy duty handle with nylon glass fibre core and polypropylene outer shell. Polyurethane bonded handle and head. Suregrip comfort grip.	9313540200719		
FLCH4	502339	<b>CLUB HAMMER 4LB/1.8KG, HARDWOOD HANDLE</b>	9313540200603		
<b>SLEDGE - TIMBER HANDLE</b>					
FLSLG/1.8WH	502395	SLEDGE HAMMER 1.8KG/4LB TIMBER HANDLE	9313540200283		
FLSLG/3.6WH	502396	SLEDGE HAMMER 3.6KG/8LB TIMBER HANDLE	9313540200290		
FLSLG/4.5WH	502397	SLEDGE HAMMER 4.5KG/10LB TIMBER HANDLE	9313540200306		
FLSLG/6.3WH	502398	SLEDGE HAMMER 6.3KG/14LB TIMBER HANDLE	9313540200313		
<b>SLEDGE - NYLON CORE</b>					
FLS1.8N	502376	<b>SLEDGE HAMMER 1.8KG/4LB, 410MM NYLON CORE HANDLE</b> Nylon shaft. Nylon core hammer. Polypropylene covering. Polyurethane bonded handle and head. Extra heavy duty handle with non-slip grip	9313540200634		
<b>SLEDGE - STEEL CORE - "FULLY HARDENED HEADS"</b>					
Suregrip Sledge Hammers. The full handle length steel core reinforces the handle and is covered with a tough polypropylene outer. As a safety feature, the head is double fixed to the handle using a combination of mechanical and chemical locking devices with a lifetime guarantee that the head will never leave the shaft.					
FLS3.6S	502380	SLEDGE HAMMER 3.6KG/8lb, 800MM STEEL CORE HANDLE	9313540200641		
FLS4.5S	502383	SLEDGE HAMMER 4.5KG/10lb, 800MM STEEL CORE HANDLE	9313540200658		
FLS6.3S	502387	SLEDGE HAMMER 6.3KG/14lb, 800MM STEEL CORE HANDLE	9313540200665		



PART NO.	ITEM	DESCRIPTION	BARCODE	IMAGE
<b>COPPER SLEDGE - NYLON CORE</b>				
FLS1.8NC	502377	<b>COPPER SLEDGE HAMMER 4lb / 1.8KG 245MM NYLON CORE HANDLE</b> Nylon core hammer with polypropylene covering. Polyurethane bonded handle and head. Extra heavy duty handle with non-slip grip	9313540200924	
<b>COPPER SLEDGE - STEEL CORE</b>				
Suregrip Sledge Hammers. The full handle length steel core reinforces the handle and is covered with a tough polypropylene outer shell. As a safety feature, the head is double fixed to the handle using a combination of mechanical and chemical locking devices with a lifetime guarantee that the head will never leave the shaft.				
FLS3.6SC	502381	<b>COPPER SLEDGE HAMMER 8lb / 3.6KG STEEL CORE HANDLE</b>	9313540200931	
FLS6.3SC	502388	<b>COPPER SLEDGE HAMMER 14lb / 6.3KG STEEL CORE HANDLE</b>	9313540200948	
<b>COPPER SLEDGE - TIMBER HANDLE</b>				
FLS3.6CW	502378	<b>COPPER SLEDGE HAMMER 8lb / 3.6KG TIMBER HANDLE</b>		
<b>SOFT FACE SLEDGE - STEEL CORE (22 to 26 Rockwell Hardness)</b>				
Suregrip Sledge Hammers. The full handle length steel core reinforces the handle and is covered with a tough polypropylene outer shell. As a safety feature, the head is double fixed to the handle using a combination of mechanical and chemical locking devices with a lifetime guarantee that the head will never leave the shaft.				
FLS3.6SS	502382	<b>SLEDGE HAMMER SOFT FACE 14lb / 3.6KG-800MM STEEL CORE HANDLE</b>	9313540200894	
FLS4.5SS	502385	<b>SLEDGE HAMMER SOFT FACE 10lb / 4.5KG-800MM STEEL CORE HANDLE</b>	9313540200900	
FLS6.3SS	502389	<b>SLEDGE HAMMER SOFT FACE 14lb / 6.3KG-800MM STEEL CORE HANDLE</b>	9313540200917	
<b>SCUTCH</b>				
FLSH	502390	<b>SCUTCH HAMMER TIMBER HANDLE</b> Total length 265mm - Head Mass 800g Scutch hammers are intended for the same purpose as brick hammers, but can take replaceable inserts in the form of scutch combs or chisel bits. Loose bits and combs are available. Designed for setting (splitting) bricks, tile and concrete blocks. - Takes 25mm scutch combs	9313540200405	
FLSHC	502392	<b>SCUTCH COMBS - 4PCS/PACK (25mm)</b>	6001844034101	
<b>SPALLING</b>				
FLSH6.3	502391	<b>SPALLING HAMMER 14lb / 6.3KG BLACK POLY HANDLE</b>	9313540200351	
<b>WEDGES</b>				
FLHW	502367	<b>HAMMER WEDGES METAL, HANG SELL PACK OF 4</b>	9313540200610	
<b>AXE</b>				
<b>BLOCK SPLITTER</b>				
FLBS	502327	<b>BLOCK SPLITTER 3KG 800MM STEEL CORE HANDLE</b> Block splitter, heavy duty steel core handle with tough polypropylene outer shell and comfort grip with 3 kg head. Ideal for splitting all types of timber.	9313540200740	

PART NO.	ITEM	DESCRIPTION	BARCODE	IMAGE
<b>KNIVES</b>				
<b>HOOKED CANE</b>				
FLCANEKNIFE	502337	HOOKED CANE KNIFE SHORT HANDLE Blade Length: 355 mm Blade Width: 2.0 mm	9313540200214	
<b>MACHETE</b>				
FLMACHETE	502371	MACHETE POLY HANDLE, 302mm	9313540200443	
<b>HACKING KNIFE</b>				
Used for cutting open old drums and slitting sheet metal. Also used for the removal of old putty from window frames. Forged from the highest quality carbon tool steel. Epoxy powder coating finish and vinyl grip for safety.				
FLHK	502366	HACKING KNIFE CARDED	9313540200627	
<b>BOLSTER</b>				
FLBB	502323	BRICK BOLSTER 100MM - PVC GRIP Brick bolster is designed to cut traditional clay bricks in half. The bolster is struck with club / lump hammer. Epoxy powder coated. Overall Length: 230 mm Blade Width: 100 mm	9313540200863	
<b>HANDLE</b>				
FLSMH	502400	MATTOCK/PICK HANDLE 900MM POLY - STEEL CORE The combination of the tough Polypropylene outer and Steel Core gives improved durability and reducing the risk of breakage. Impact resistant especially from overstrikes. Eliminates splinters. Will not rot. Lighter and better shaft design giving user more comfort during use. Consistent product – quality standards. It will outlast the pick / mattock head.	6001844003381	
<b>SCRAPER</b>				
<b>FLOOR SCRAPER</b>				
FLLHMS	502368	FLOOR SCRAPER 190MM BLADE 1300MM HANDLE	9313540200009	
FLLHMS/S	502369	FLOOR SCRAPER SPARE BLADE TO SUIT FLLHMS	9313540199990	











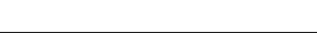















# TRAMONTINA

Tramontina is a highly diversified Brazilian manufacturer offering a range of quality forged hammers and hardwood handles.

All handles are kiln dried, fine sanded & lacquered ensuring long life even in dry environments



PART NO.	ITEM	DESCRIPTION	BARCODE	IMAGE
<b>HAMMERS</b>				
<p>The head is forged and hardened with special steel assuring great resistance to the product. Perfect balance between head and handle to increase comfort and safety. The fixing system by epoxy resin or steel wedges helps to increase the safety. The hammer's head is protected against rust with varnish or electrostatic painting. The hammers are subjected to a specific hardening process to give a suitable hardness at the striking face and claw/pein to ensure long life. Tools are produced and tested according to specific standards</p>				
<b>BALL PEIN</b>				
Ball Pein Hammer polished. Drop forged head, polished face, hardwood handle				
TR40400/004	509035	HAMMER BALL PEIN 4OZ/100GR TIMBER HANDLE	7891114045222	
TR40400/008	509036	HAMMER BALL PEIN 8OZ/200G TIMBER HANDLE	7891114045239	
TR40400/012	509037	HAMMER BALL PEIN 12OZ/300g TIMBER HANDLE	7891114045246	
TR40400/016	509038	HAMMER BALL PEIN 16OZ 400g TIMBER HANDLE	7891114045253	
TR40400/024	509039	HAMMER BALL PEIN 24OZ/600G TIMBER HANDLE	7891114045277	
TR40400/032	509040	HAMMER BALL PEIN 32OZ/800G TIMBER HANDLE	7891114045284	
TR40400/040	509041	HAMMER BALL PEIN 40OZ/1KG TIMBER HANDLE	7891114045291	
<b>CLAW HAMMER - Fibreglass Handle</b>				
TR40700/027	509047	CLAW HAMMER 20 OZ FIBREGLASS HANDLE Forged and hardened special steel head. Polished and varnished head. Fibreglass handle fixed with epoxy and elastic safety pin. Injected PVC grip. Size: 27mm	7891114001006	
<b>CLAW HAMMER - Timber Handle</b>				
Forged and hardened special steel head. Polished and varnished head. Hardwood handle fixed with epoxy.				
TR40200/27	509033	CLAW HAMMER 20oz TIMBER HANDLE	7891114000658	
TR40200/29	509034	CLAW HAMMER 24oz TIMBER HANDLE	7891114000665	
<b>CLUB HAMMER - Fibreglass Handle</b>				
TR40720/002	509048	CLUB HAMMER 3lb / 1.2KG FIBREGLASS HANDLE	7891114004816	
<b>CLUB HAMMER - Timber Handle</b>				
TR40503/002	509045	CLUB HAMMER 2.5lb / 1.1KG TIMBER HANDLE Double face club hammer painted black. Drop forged steel, heat treated and fully painted head with polished face. Hardwood handle fixed with epoxy.	7891114002812	
<b>CROSS PEIN</b>				
Cross Pein hammer, polished, drop forged head, polished face and pein, hardwood handle				
TR40402/012	509044	HAMMER CROSS PEIN 12oz / 300g TIMBER HANDLE	7891114004229	
<b>ENGINEERS</b>				
TR40504/004	509046	ENGINEERS HAMMER 5lb / 2KG TIMBER HANDLE Double face engineers hammer painted black. Drop forged steel, heat treated and fully painted head with polished face. Hardwood handle fixed with epoxy.	7891114004328	

PART NO.	ITEM	DESCRIPTION	BARCODE	IMAGE
<b>HANDLES</b>				
TRA600	509057	AXE HANDLE 600MM - HARDWOOD	9313540880010	
TRA700	509058	AXE HANDLE 700MM - HARDWOOD	9313540880027	
TRA800	509059	AXE HANDLE 800MM - HARDWOOD	9313540880034	
TRBP250	509063	BALL PEIN HAMMER HANDLE 250MM - HARDWOOD	9313540880041	
TRBP300	509064	BALL PEIN HAMMER HANDLE 300MM - HARDWOOD	9313540880058	
TRBP350	509065	BALL PEIN HAMMER HANDLE 350MM - HARDWOOD	9313540880065	
TRBP400	509066	BALL PEIN HAMMER HANDLE 400MM - HARDWOOD	9313540880072	
TRBP450	509067	BALL PEIN HAMMER HANDLE 450MM - HARDWOOD	9313540880089	
TRB1350/22	509060	BROOM HANDLE 22MM X 1350MM - HARDWOOD	9313540880119	
TRB1500/25	509061	BROOM HANDLE 25MM X 1500MM - HARDWOOD	9313540880126	
TRB1800/25	509062	BROOM HANDLE 25MM x 1800MM - HARDWOOD	9313540880133	
TRCL360	509070	CLAW HAMMER HANDLE 360MM - HARDWOOD	7896403730810	
TRC250	509068	CLUB HAMMER HANDLE 250MM - HARDWOOD	9313540880157	
TRA380	509056	HATCHET HANDLE 380MM - HARDWOOD	9313540880164	
TRH1350	509071	HOE HANDLE 1350MM - HARDWOOD	9313540880171	
TRH1500	509072	HOE HANDLE 1500MM - HARDWOOD	9313540880188	
TRMP900	509073	MATTOCK/PICK HANDLE 900MM - HARDWOOD	9313540880195	
TRR1350/25	509074	RAKE HANDLE 25MM X 1350MM - HARDWOOD	9313540880201	
TRR1500/25	509075	RAKE HANDLE 25MM X 1500MM - HARDWOOD	9313540880225	
TRR1500/29	509076	RAKE HANDLE 29MM X 1500MM - HARDWOOD	9313540880218	
TRSLB1300	509081	SHOVEL HANDLE BENT 1300MM HARDWOOD	9313540880232	
TRSD670	509080	SHOVEL/FORK HANDLE 670MM PLAS."D" STR HARDWOOD	9313540880256	
TRS600	509077	SLEDGE HANDLE 600MM - HARDWOOD	9313540880263	
TRS750	509078	SLEDGE HANDLE 750MM - HARDWOOD	9313540880270	
TRS900	509079	SLEDGE HANDLE 900MM - HARDWOOD	9313540880287	
TRWS750	509082	WOOD SPLITTER HANDLE 750MM - HARDWOOD	9313540880096	
TRWS900	509083	WOOD SPLITTER HANDLE 900MM - HARDWOOD	9313540880102	

## REFORESTATION AND THE ENVIRONMENT

Following are extracts from the Tramontina website explaining their commitment to the environment and reforestation, their membership of (FSC) the Forest Stewardship Council etc.

FSC certification is voluntary and has as its main goal to identify companies, communities, associations that adopt good practices of forest handling, according to strict environmental, social and economic standards.

Tramontina is certified by Imaflo/SmartWood's Program that is a linked program to the SmartWood network, which brings together non-profit independent certifiers, present in 10 countries and led by the American Rainforest Alliance, with its headquarters in New York, USA. SmartWood is the world's largest and oldest program of certification and one of the members of the Forest Stewardship Council (FSC), the international organisation recognised for monitoring the certification of forest production.

For Tramontina, the FSC certificate is an asset which differentiates it from other suppliers and is recognised and valued, especially by the Australian market. The Tramontina Group believes that the forest is important for the conservation of the soil, preservation of animal life, renovation of the air, for the balance of the water sources and for the supply of wood. The group understands that the forest is vital for the ecosystem Earth. Therefore, besides investing in the industrial area, the Tramontina Group is also investing in reforestation.

The important reforestation project developed by Tramontina in the State of Para, in the Aurora do Para County, is aimed exactly at the recovery of the these degraded areas through the heterogeneous reforestation system (mahogany, cedar, senna and other species).

For each m<sup>2</sup> of raw material used to manufacture wood products, Tramontina Belém plants 6 noble species tree samplings. Annually 70,000 new trees are planted, which besides allowing the regeneration of semi-destroyed forests, prevent the extinction of the native species.

The reforestation with noble species, supplemented with rapid growth species, to cut at 25 years intervals, offer an average production of 300 m<sup>2</sup>/ha. In a native forest, this production is about 40 m<sup>2</sup>/ha in 50 years intervals.

## Environmental Preservation Policy

Tramontina invests in production forests, as they are aware that it is fundamental to preserve forests, for the protection of the soil and wildlife, for the renewal of the air and balancing of the water tables and for the supply of wood, as a noble raw material, that is renewable and biodegradable.

Wood is a renewable component, and during its decomposition, it is naturally absorbed by the environment. This defines it as a very desirable ecological raw material. The planned management of forests, observing strict technical parameters, contributes to control the climate, establish the soil, avoid runoff into rivers, preserves the fauna, filters pollutants and reduces the risks of global warming, amongst other benefits.





## GERMAN QUALITY SINCE 1862

Stahlwille are committed to designing and manufacturing “State of the art” tools to maximize customer satisfaction.

- Perfect tools designed for practical applications.
- Stahlwille’s entire range of tightening tools are manufactured exclusively in German production facilities from the forging blank to the finished product.
- Stahlwille hand tools are designed on the basis that they are an extension of your hand. Intelligent design provides tools with optimum load capacity, close tolerances and ergonomic qualities that are the

## BEST IN THE WORLD.

- Tools marked as “High Performance Quality®” exceed the stringent requirements of American and European aerospace standards



### TERMS AND CONDITIONS

Our warranty commences from the date of purchase and is not transferable. The warranty only covers the original owner, purchaser or end user and is subject to the Trade Practices Act and Goods and Consumer Protection legislation of the various states. Proof of purchase along with appropriate documentations is required before consideration under warranty is given.

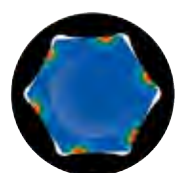

# Tool solutions for aircraft

**AOG  
Mobile Maintenance  
Tool Kits  
Maintenance Kits  
Cabin Kits  
Line Maintenance Sets**



Everything in its place and a place for everything. A working environment with interdependent processes and tight schedules requires sophisticated, intelligent and intuitive tool storage. The same holds true for safety-critical maintenance operations, such as aerospace and food processing plants.

The STAHLWILLE Tool Control System combines the highest degree of safety and efficiency with the confidence that no tool is left where it may pose a security risk.

Originally developed for the aerospace industry together with leading aerospace manufacturers, the award-winning STAHLWILLE Tool Control System gives you control over your tools and ensures a high level of organisation and security.





13232a

**Cabin Kit Systems Mechanic imperial**



13225a

**Line Maintenance Set imperial**



13237

**Maintenance Mechanic Eurocopter metric + imperial**



Code 97 83 00 74  
21.07 kg, 46.46 lbs  
Number of tools: 253 - Tool trolley not included.

13223

**AOG Kit Avionic metric**



# Value Packs

## SWVP10/6

### 6 Piece Metric Double Open Ended Spanner Set

Contents	Ø mm	L mm
40 03 10 11	10 x 11	155
40 03 12 13	12 x 13	170
40 03 14 15	14 x 15	190
40 03 16 17	16 x 17	205
40 03 18 19	18 x 19	220
40 03 20 22	20 x 22	235



SW Code	Item Code	Description
SWVP10/6	709728	6 Piece in plastic display pack

## SWVP14/8

### 8 Piece Long Metric Ring Open End Spanner Set

Contents	Ø mm	L mm
40 10 08 08	8	145
40 10 10 10	10	165
40 10 12 12	12	180
40 10 13 13	13	195
40 10 14 14	14	210
40 10 15 15	15	215
40 10 17 17	17	240
40 10 19 19	19	265



SW Code	Item Code	Description
SWVP14/8	709739	8 Piece in plastic display pack

## SWVP10a/5

### 5 Piece Imperial Double Open Ended Spanner Set

Contents	Ø "	L mm
40 43 24 28	3/8 x 7/16	155
40 43 32 34	1/2 x 9/16	205
40 43 36 38	5/8 x 11/16	205
40 43 40 44	3/4 x 7/8	235
40 43 46 48	15/16 x 1	270



SW Code	Item Code	Description
SWVP10a/5	709732	5 Piece in plastic display pack

## SWVP20/5

### 5 Piece Metric Ring Spanner Set

Contents	Ø mm	L mm
41 04 10 11	10 x 11	200
41 04 12 13	12 x 13	220
41 04 14 15	14 x 15	245
41 04 16 17	16 x 17	255
41 04 18 19	18 x 19	275



SW Code	Item Code	Description
SWVP20/5	709742	5 Piece in plastic display pack

## SWVP13/9

### 9 Piece Metric Ring Open End Spanner Set

Contents	Ø mm	L mm
40 08 08 08	8	115
40 08 10 10	10	125
40 08 12 12	12	140
40 08 13 13	13	160
40 08 14 14	14	165
40 08 15 15	15	170
40 08 16 16	16	180
40 08 17 17	17	190
40 08 19 19	19	230



SW Code	Item Code	Description
SWVP13/9	709734	9 Piece in plastic display pack

## SWVP20a/5

### 5 Piece Imperial Ring Spanner Set

Contents	Ø "	L mm
41 44 16 20	1/4 x 5/16	180
41 44 24 28	3/8 x 7/16	200
41 44 32 34	1/2 x 9/16	220
41 44 36 40	5/8 x 3/4	270
41 44 38 42	11/16 x 13/16	300



SW Code	Item Code	Description
SWVP20a/5	709746	5 Piece in plastic display pack

## SWVP13a/7

### 7 Piece Imperial Ring Open End Spanner Set

Contents	Ø "	L mm
40 48 24 24	3/8	125
40 48 28 28	7/16	135
40 48 32 32	1/2	160
40 48 34 34	9/16	165
40 48 36 36	5/8	180
40 48 38 38	11/16	200
40 48 40 40	3/4	230



SW Code	Item Code	Description
SWVP13a/7	709736	7 Piece in plastic display pack

## SWVP21/4

### 4 Piece Metric Short Ring Spanner Set

Contents	Ø mm	L mm
41 05 08 10	8 x 10	115
41 05 12 13	12 x 13	150
41 05 14 15	14 x 15	165
41 05 16 17	16 x 17	170



SW Code	Item Code	Description
SWVP21/4	709748	4 Piece in plastic display pack

### SWVP21TX/4 4 Piece Torx® Double Ended Spanner Set

Contents	⌀ mm	L mm
41 25 06 08	E6 X E8	115.5
41 25 10 12	E10 X E12	149.5
41 25 14 18	E14 X E18	185
41 25 20 24	E20 X E24	227



SW Code	Item Code	Description
SWVP21TX/4	709750	4 Piece in plastic display pack

### SWVP24/3 3 Piece Metric Flare Nut Spanner Set

Contents	⌀ mm	L mm
41080810	8 x 10	145
41081113	11 x 13	170
41081214	12 x 14	180



SW Code	Item Code	Description
SWVP24/3	709755	3 Piece in plastic display pack

### SWVP24A/2 2 Piece Imperial Flare Nut Spanner Set

Contents	⌀ "	L mm
41 48 24 28	3/8 X 7/16	155
41 48 32 34	1/2 X 9/16	180



SW Code	Item Code	Description
SWVP24a/2	709757	2 Piece in plastic display pack

### SWVP49/5 5 Piece Metric Inhex 3/8" Drive Socket Set

Contents	⌀ mm	L mm
02 05 00 03	3	52
02 05 00 04	4	52
02 05 00 05	5	52
02 05 00 06	6	52
02 05 00 08	8	52
80 45 00 01	clipstrip	



SW Code	Item Code	Description
SWVP49/5	709764	5 Piece on clipstrip with plastic display pack

### SWVP54/6 6 Piece Metric Inhex 1/2" Drive Socket Set

Contents	⌀ mm	L mm
03 05 00 05	5	60
03 05 00 06	6	60
03 05 00 08	8	60
03 05 00 10	10	60
03 05 00 12	12	60
03 05 00 14	14	60
80 45 00 01	clipstrip	



SW Code	Item Code	Description
SWVP54/6	709766	6 Piece on clipstrip with plastic display pack

### SWVP2049/5 5 Piece Metric Long Inhex 3/8" Drive Socket Set

Contents	⌀ mm	L mm
02 15 10 04	4	100
02 15 10 05	5	100
02 15 10 06	6	100
02 15 12 08	8	100
02 15 12 10	10	100



SW Code	Item Code	Description
SWVP2049/5	709744	5 Piece in plastic display pack

### SWVP1054/4 4 Piece Metric Long Inhex 1/2" Drive Socket Set

Contents	⌀ mm	L mm
03151206	6	120
03151208	8	100
03151410	10	140
03151412	12	140



SW Code	Item Code	Description
SWVP1054/4	709730	4 Piece in plastic display pack

### GLOVE Mechanics Gloves

Close fitting padded gloves for professional workshop use. Gives protection, comfort and allows the user to carry out delicate work without loss of finger sensitivity



SW Code	Item Code	Size
SWGLOVE-M	709597	Medium
SWGLOVE-L	709596	Large
SWGLOVE-XL	709598	X-Large



## Strong, extremely tough and durable. STAHLWILLE spanners

1

### Conventional spanners

When force is applied to a spanner, the greatest force acts on the joint between the jaw and the shaft. Standard-quality open-jaw spanners do not take this fact into consideration. In the context of normal hard work, this can lead to the tool breaking, causing considerable personal injury.

### STAHLWILLE spanners

To reduce the danger of breakage, we add more material where the greatest loads are to be found and take it away from the places that are not under such stress.

In this way, we are able to manufacture extremely sturdy, slim and light tools which also facilitate working in confined spaces due to their compact designs.

2

### Extremely resilient, remarkably durable

- Drop-forged from high-grade special steels.
- Optimum hardening in continuous furnaces with no scale build-up or skin decarburisation.
- Gentle quenching in oil.

3

### Light and easy to handle

- High resistance to bending and low weight thanks to STAHLWILLE's typical double-T profile.
- Snug-fitting, skin-friendly surfaces thanks to STAHLWILLE's rounded finish.

4

### Key benefits when tightening and loosening screws

- Tougher than any screw thanks to the forged double hex.
- Thinner than conventional rings – facilitating work in confined spaces.
- Higher than standard nuts – prevents the spanner jamming on the nut.

5

### Quality assured

STAHLWILLE's Quality Assurance System was awarded an internationally recognised certificate in accordance with DIN ISO 9001 by the DQS (German Association for the Certification of Quality Assurance Systems).



This one – and the next one:  
tailored to fit – perfect  
chrome plating

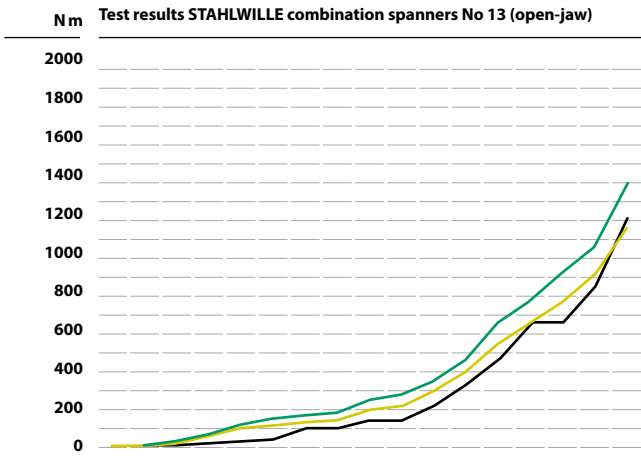

Size	6	8	10	13	16	17	18	19	21	22	24	27	30	32	34	36	41
Thread M	3,5	5	6	8	10	*10	12	*12	14	*14	16	18	20	*22	22	24	27

- Test results for STAHLWILLE
- Test results to DIN 899 or ISO 1711
- Clamping torque for 8.8 screws at 100% tensile yield strength ( $\mu=0,14$ )  
\*Reference to older screw thread standards

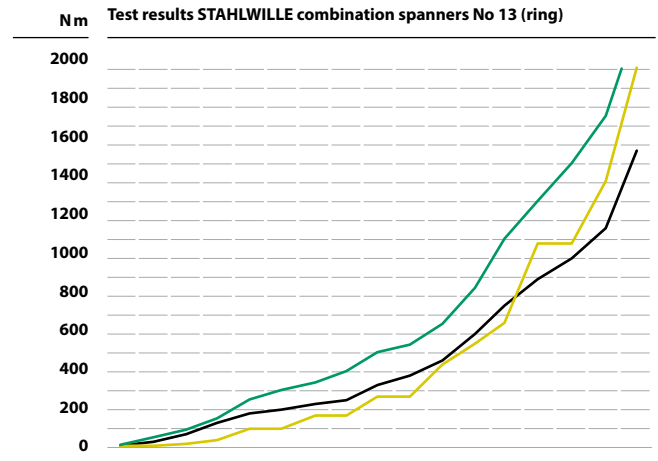

Size	6	8	10	13	16	17	18	19	21	22	24	27	30	32	34	36	41
Thread M	3,5	5	6	8	10	*10	12	*12	14	*14	16	18	20	*22	22	24	27

- Test results for STAHLWILLE
- Test results to DIN 899 or ISO 1711
- Clamping torque for 12.9 screws at 100% tensile yield strength ( $\mu=0,14$ )



Load zones in standard-quality spanners

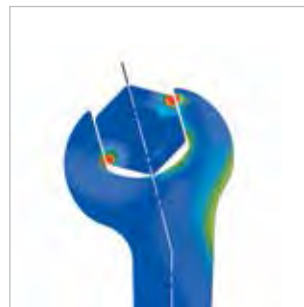

Load zones in spanners by STAHLWILLE

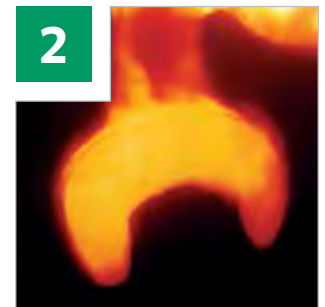

Open-jaw spanners in oil



Absolutely resistant to bending thanks to the double-T profile



Snug-fitting, skin-friendly surfaces thanks to STAHLWILLE's rounded finish

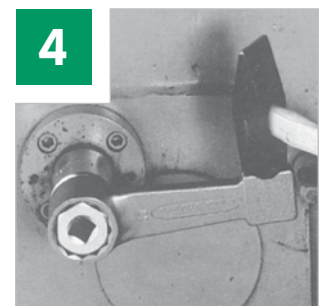

STAHLWILLE No 8 striking face double hex box-spanners are tougher, thinner and higher.







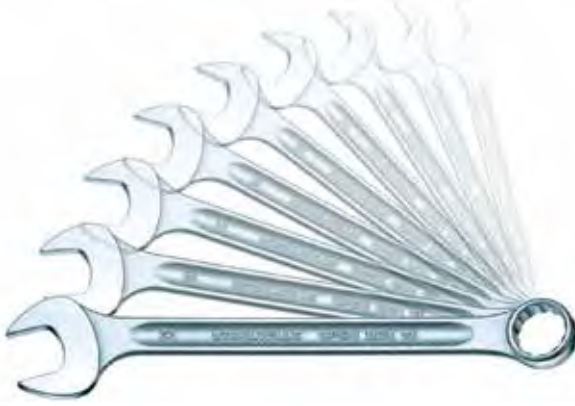

### Sets: Combination spanners OPEN-BOX

SW Code	Item Code	No.	Content mm/"	△	g
96 40 08 13	706040 <sup>^</sup>	13/6 <sup>3)</sup>	7; 8; 10; 13; 17; 19mm		430
96 40 08 01	706041 <sup>^</sup>	13/9	9; 10; 11; 12; 13; 14; 17; 19; 22mm		758
96 40 08 08	706027	13/10KT <sup>1)</sup>	8; 9; 10; 11; 12; 13; 14; 15; 17; 19mm		746
96 40 08 02	706030 <sup>^</sup>	13/11	8; 9; 10; 11; 12; 13; 14; 15; 17; 19; 22mm		915
96 40 08 03	706032 <sup>^</sup>	13/15	6; 7; 8; 9; 10; 11; 12; 13; 17; 19; 22; 24; 27; 30; 32mm		2236
96 40 08 16	706033 <sup>^</sup>	13/16 <sup>2)</sup>	7; 8; 9; 10; 11; 12; 13; 14; 15; 16; 17; 18; 19; 21; 22; 24mm		1620
96 40 08 04	706034 <sup>^</sup>	13/17	6; 7; 8; 9; 10; 11; 12; 13; 14; 15; 16; 17; 18; 19; 20; 21; 22mm		1493
96 40 08 05	706039	13/26 <sup>2)</sup>	6; 7; 8; 9; 10; 11; 12; 13; 14; 15; 16; 17; 18; 19; 20; 21; 22; 23; 24; 25; 26; 27; 28; 29; 30; 32mm		4705
96 40 48 03	706121 <sup>^</sup>	13a/8	7/16; 1/2; 9/16; 5/8; 11/16; 3/4; 13/16; 7/8"		959
96 40 48 12	706113	13a/10KT <sup>1)</sup>	1/4; 5/16; 11/32; 3/8; 7/16; 1/2; 9/16; 5/8; 11/16; 3/4"		750
96 40 48 04	706118	13a/20 <sup>2)</sup>	1/4; 9/32; 5/16; 11/32; 3/8; 7/16; 1/2; 9/16; 19/32; 5/8; 11/16; 3/4; 25/32; 13/16; 7/8; 15/16; 1; 1 1/16; 1 1/8; 1 1/4"		3210

Standard packing: clear view wallet.

<sup>1)</sup> carton with clear view cover

<sup>2)</sup> packed in carton

<sup>3)</sup> in convenient clip holder

### TCS 13/17



Foam: 350 x 350 x 60mm

SW Code	Item Code	No.	Content mm	△	g
96 83 01 64	706035 <sup>^</sup>	TCS 13/17	6; 7; 8; 9; 10; 11; 12; 13; 14; 15; 16; 17; 18; 19; 21; 22; 24mm		1615

### TCS 13/21



in TCS inlay

Foam: 530 x 350 x 75mm

SW Code	Item Code	No.	Content mm	△	g
96 83 01 74	706037 <sup>^</sup>	TCS 13/21	6; 7; 8; 9; 10; 11; 12; 13; 14; 15; 16; 17; 18; 19; 21; 22; 24; 27; 30; 32; 34mm		3571

### 14

### Combination spanners OPEN-BOX, long



DIN 3113 form B/ ISO 7738 form B,  
Chrome Alloy Steel, chrome plated.

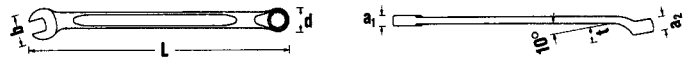

SW Code	Item Code	mm	L mm	b mm	d mm	a <sub>1</sub> mm	a <sub>2</sub> mm	t mm	△	g
40 10 06 06	706158	6	125	14	9.5	4.5	6	7	18	10
40 10 07 07	706160	7	135	16	10.8	5	7	8	25	10
40 10 08 08	706162	8	145	17.5	12.1	5	7	8	28	10
40 10 09 09	706164	9	155	19	13.3	5.5	8	9	34	10
40 10 10 10	706122	10	165	21	14.6	5.5	8	9	43	10
40 10 11 11	706124	11	180	23.5	15.9	6	9	10	55	10
40 10 12 12	706126	12	180	25.5	17.3	6	9	10	61	10
40 10 13 13	706128	13	195	27.5	18.6	6.5	10	11	83	10
40 10 14 14	706130	14	210	29.5	20.1	6.5	10	11	88	10
40 10 15 15	706132	15	215	31	21.4	7	11	13	109	10
40 10 16 16	706134	16	230	33	22.7	7	11	14	108	10
40 10 17 17	706136	17	240	35	24.1	7.5	12	15	151	10
40 10 18 18	706138	18	255	37	25.5	7.5	12	16	151	10
40 10 19 19	706140	19	265	39.5	27	8	13	18	190	10
40 10 20 20	706142	20	280	41.5	28.5	8	13	19	219	10
40 10 21 21	706143	21	280	43	29.8	8.5	13	19	244	10
40 10 22 22	706144	22	300	45	31.3	8.5	14	20	268	10
40 10 24 24	706147	24	330	50	34.3	9.5	14	22	363	5
40 10 27 27	706150	27	385	56	38.6	10.5	16	24	502	5
40 10 30 30	706152	30	415	63	42.6	12	18	26	645	5
40 10 32 32	706153	32	430	67	45.2	12	18	27	666	5
40 10 34 34	706155	34	460	72	48	13	18	27	900	1
40 10 36 36	706156	36	480	74	50.8	13	19	28	951	1
40 10 41 41	706157	41	560	84	57.8	14	20	32	1322	1



### Tool Control System The safety inlay system

Designed to fit Stahlwille Tool Trolleys and Tool Boxes

With yellow signal cut-outs to show whether all tools are in their places

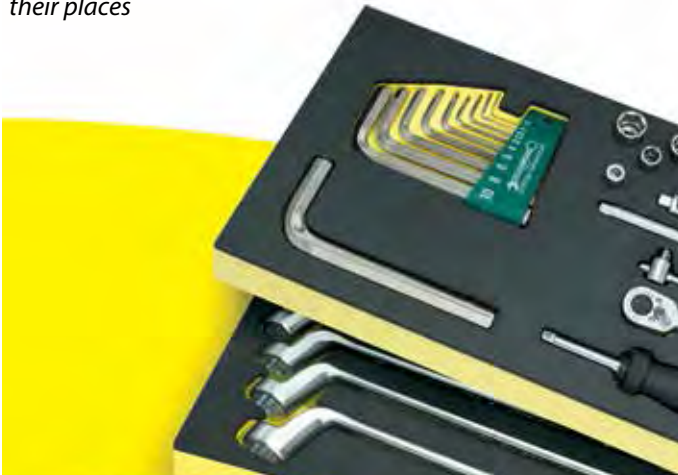





### Sets: Combination spanners OPEN-BOX, long

SW Code	Item Code	No.	Content mm	△△ g
96 40 10 08	706177	14/6 <sup>2)</sup>	10; 13; 17; 19; 22; 24mm	1175
96 40 10 09	706181 <sup>^</sup>	14/9 <sup>2)</sup>	10; 11; 13; 17; 19; 22; 24; 27; 30mm	2395
96 40 10 07	706169	14/10 KT <sup>1)</sup>	8; 10; 11; 12; 13; 14; 16; 17; 18; 19mm	1235
96 40 10 06	706170 <sup>^</sup>	14/11	8; 9; 10; 11; 12; 13; 14; 15; 17; 19; 22mm	1465
96 40 10 04	706171	14/15	6; 7; 8; 9; 10; 11; 12; 13; 17; 19; 22; 24; 27; 30; 32mm	3370
96 40 10 10	706174 <sup>^</sup>	14/15N <sup>2)</sup>	10; 11; 12; 13; 14; 15; 16; 17; 18; 19; 21; 22; 24; 27; 30mm	3165
96 40 10 05	706175 <sup>^</sup>	14/17	6; 7; 8; 9; 10; 11; 12; 13; 14; 15; 16; 17; 18; 19; 20; 21; 22mm	1874

Standard packing: clear view wallet.

<sup>1)</sup> packed in plastic with transparent cover

<sup>2)</sup> packed in carton

## 12

### Small double open ended spanners ELECTRIC

Chrome Alloy Steel, chrome plated.

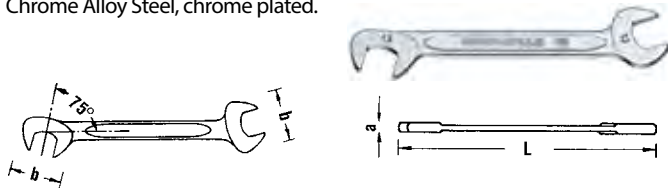

SW Code	Item Code	△ mm	L mm	b mm	a mm	△△ g	☐
40 06 32 32	705682	3.2	70	10.5	2	5	10
40 06 35 35	705683	3.5	70	10.5	2	5	10
40 06 04 04	705684	4	70	10.5	2	5	10
40 06 45 45	705685	4.5	70	10.5	2	5	10
40 06 05 05	705686	5	78	12.6	2	7	10
40 06 55 55	705687	5.5	78	12.6	2	7	10
40 06 06 06	705688	6	78	12.6	2	6	10
40 06 07 07	705689	7	91	14.7	2	9	10
40 06 08 08	705690	8	96	16.8	3	16	10
40 06 09 09	705691	9	103	18.9	3	19	10
40 06 10 10	705676	10	105	21	3	22	10
40 06 11 11	705677	11	116	24.2	3	27	10
40 06 12 12	705678	12	116	24.2	3	27	10
40 06 13 13	705679	13	131	28.3	3	37	10
40 06 14 14	705680	14	131	28.3	3	36	10

## 12a

### Small double open ended spanners ELECTRIC

SW Code	Item Code	△ "	L mm	b mm	a mm	△△ g	☐
40 46 10 10	705700	5/32	70	10.5	2	5	10
40 46 12 12	705697	3/16	70	10.5	2	5	10
40 46 13 13	705695	13/64	78	12.6	2	7	10
40 46 14 14	705702	7/32	78	12.6	2	6	10
40 46 15 15	705696	15/64	78	12.6	2	6	10
40 46 16 16	705693	1/4	91	14.7	2	9	10
40 46 18 18	705704	9/32	91	14.7	2	9	10
40 46 20 20	705699	5/16	96	16.8	3	16	10
40 46 22 22	705694	11/32	103	18.9	3	19	10
40 46 24 24	705698	3/8	105	21	3	22	10
40 46 28 28	705701	7/16	116	24.2	3	28	10
40 46 32 32	705692	1/2	131	28.3	3	37	10
40 46 34 34	705703	9/16	131	28.3	3	36	10



### Sets: Small double open ended spanners ELECTRIC

SW Code	Item Code	No.	Content mm/"	△△ g
96 40 06 53	705705	12/10Pc	4; 4.5; 5; 5.5; 6; 7; 8; 9; 10; 11mm	161
96 40 06 51	705706	12/15Pc	3.2; 3.5; 4; 4.5; 5; 5.5; 6; 7; 8; 9; 10; 11; 12; 13; 14mm	296
96 40 46 54	705940	12a/13Pc	5/32; 3/16; 13/64; 7/32; 15/64; 1/4; 9/32; 5/16; 11/32; 3/8; 7/16; 1/2; 9/16"	270

Pc: in plastic-wallet



**20 Double ended ring spanners**

AS-drive

**StahlwilleSTABIL®**

offset, DIN 838/ISO 10104 (metric sizes),  
Chrome Alloy Steel, chrome plated.

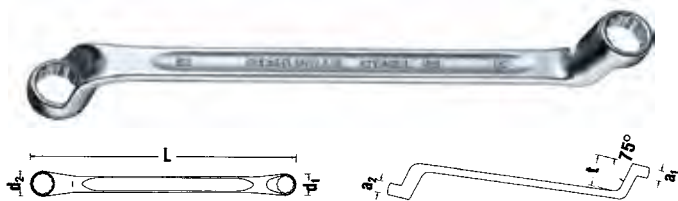

SW Code	Item Code	⌀ mm	L mm	d <sub>1</sub> mm	d <sub>2</sub> mm	a <sub>1</sub> mm	a <sub>2</sub> mm	t mm	g	
41 04 06 07	706354	6 x 7	165	10.5	11.8	6	7	18	46	10
41 04 08 09	706357	8 x 9	180	13.1	14.5	7	8	20	62	10
41 04 08 10	706356	8 x 10	180	13.1	15.8	7	9	21	61	10
41 04 10 11	706327	10 x 11	200	15.8	17.2	9	9	23	93	10
41 04 10 13	706329 <sup>^</sup>	10 x 13	220	15.8	20	9	10	25	122	10
41 04 12 13	706330	12 x 13	220	18.6	20	9	10	25	126	10
41 04 13 17	706331	13 x 17	245	20	25.3	10	12	27	169	10
41 04 14 15	706332	14 x 15	245	21.3	22.6	10	12	27	163	10
41 04 16 17	706334	16 x 17	255	23.9	25.3	11	12	27	181	10
41 04 17 19	706336	17 x 19	270	25.3	28	12	13	29	220	10
41 04 18 19	706337	18 x 19	275	26.6	28	12	13	29	228	10
41 04 18 21	706338	18 x 21	300	26.6	30.7	12	13	31	279	10
41 04 19 22	706339	19 x 22	300	28	32.1	13	14	31	315	10
41 04 20 22	706340	20 x 22	300	29.4	32.1	13	14	31	317	5
41 04 21 23	706341	21 x 23	315	30.7	33.4	13	14	31	312	5
41 04 21 24	706342	21 x 24	330	30.7	34.7	13	14	34	384	5
41 04 22 24	706343	22 x 24	330	32.1	34.7	14	14	34	368	5
41 04 24 26	706344	24 x 26	330	34.7	37.3	14	15	34	427	5
41 04 24 27	706345	24 x 27	330	34.7	38.6	14	15	34	447	5
41 04 25 28	706346	25 x 28	350	36	40	14	15	34	414	5
41 04 27 30	706347	27 x 30	360	38.3	42.6	15	15	37	595	5
41 04 27 32	706348	27 x 32	360	39.3	47.2	15	16	37	596	5
41 04 30 32	706349	30 x 32	365	42.6	45.4	15	16	37	603	5
41 04 30 34	706350	30 x 34	365	42.6	48	15	16	37	670	1
41 04 34 36	706351 <sup>^</sup>	34 x 36	400	48	51	16	17	38	750	1
41 04 36 41	706352	36 x 41	440	53	60	17	18	40	1063	1
41 04 46 50	706353	46 x 50	535	65.2	73	19	20	45	1015	1



**Sets: Double ended ring spanners**

**StahlwilleSTABIL®**  
offset.

SW Code	Item Code	No.	Content mm/"	
96 41 04 08	706378	20/7N	6 x 7; 8 x 9; 10 x 11; 12 x 13; 14 x 15; 16 x 17; 18 x 19mm	930
96 41 04 05	706379	20/8	6 x 7; 8 x 9; 10 x 11; 12 x 13; 14 x 15; 16 x 17; 18 x 19; 20 x 22mm	1291
96 41 04 09	706381 <sup>^</sup>	20/9	6 x 7; 8 x 9; 10 x 11; 12 x 13; 14 x 15; 16 x 17; 18 x 19; 20 x 22; 21 x 24mm	1650
96 41 04 07	706374	20/10	6 x 7; 8 x 9; 10 x 11; 12 x 13; 14 x 15; 16 x 17; 18 x 19; 20 x 22; 24 x 27; 30 x 32mm	2331
96 41 04 06	706377	20/12	6 x 7; 8 x 9; 10 x 11; 12 x 13; 14 x 15; 16 x 17; 18 x 19; 20 x 22; 21 x 23; 24 x 27; 25 x 28; 30 x 32mm	3137
96 41 44 02	706408	20a/6	1/4 x 5/16; 3/8 x 7/16; 1/2 x 9/16; 5/8 x 3/4; 11/16 x 13/16; 7/8 x 15/16"	1244
96 41 44 05	706407	20a/10	1/4 x 5/16; 3/8 x 7/16; 1/2 x 9/16; 9/16 x 5/8; 19/32 x 11/16; 5/8 x 3/4; 11/16 x 13/16; 3/4 x 7/8; 25/32 x 13/16; 7/8 x 15/16"	2260

Standard packing: carton

**20a Double ended ring spanners**

SW Code	Item Code	⌀ "	L mm	d <sub>1</sub> mm	d <sub>2</sub> mm	a <sub>1</sub> mm	a <sub>2</sub> mm	t mm	g	
41 44 16 20	706359	1/4 x 5/16	180	11.8	13.1	7	7	20	61	10
41 44 24 28	706365	3/8 x 7/16	200	15.8	17.2	9	9	23	88	10
41 44 32 34	706358	1/2 x 9/16	220	20	21.3	9	10	25	131	10
41 44 34 36	706368	9/16 x 5/8	245	21.3	25.3	10	12	27	168	10
41 44 35 38	706362	19/32 x 11/16	255	23.9	25.3	11	12	27	177	10
41 44 36 40	706366	5/8 x 3/4	270	23.9	28	12	13	29	235	10
41 44 38 42	706360	11/16 x 13/16	300	25.3	30.7	12	13	31	280	5
41 44 40 44	706364	3/4 x 7/8	300	28	32.1	13	14	31	299	5
41 44 41 42	706363	25/32 x 13/16	300	29.4	32.1	13	14	31	333	5
41 44 44 46	706367	7/8 x 15/16	330	32.1	34.7	14	14	34	363	5
41 44 46 48	706361	15/16 x 1	330	34.7	37.3	14	15	34	419	5
41 44 52 58	706406 <sup>^</sup>	1 1/8 x 1 1/16	365	42.6	45.4	15	16	37	581	1

**16 Combination spanners OPEN-BOX**

ISO 3318,  
Chrome Alloy Steel,  
chrome plated.

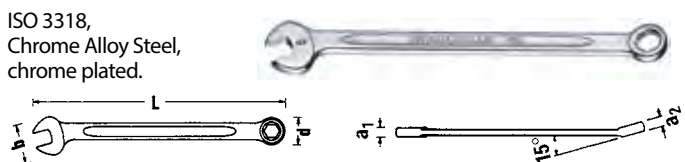

SW Code	Item Code	⌀ mm	L mm	b mm	d mm	a <sub>1</sub> mm	a <sub>2</sub> mm	t mm	g	
40 09 32 32	706293	3.2	75	10	6.6	3	3.2	6	10	10
40 09 35 35	706294	3.5	75	10	6.6	3	3.2	6	10	10
40 09 40 40	706295	4	85	12.5	7.8	3	3.2	9	10	10
40 09 45 45	706296	4.5	85	12.5	7.8	3	3.2	8	10	10
40 09 50 50	706297	5	95	14	9.8	3	3.2	11	10	10

**16/5Pc Set: Combination spanners OPEN-BOX**



SW Code	Item Code	No.	Content mm	
96 40 09 02	706298	16/5Pc	3.2; 3.5; 4; 4.5; 5mm	46

Pc: in green plastic-wallet





**Sets: Double ended ring spanners**

SW Code	Item Code	No.	Content mm	g
96 41 05 03	706434	21/7	8 x 9; 10 x 11; 12 x 13; 14 x 15; 16 x 17; 18 x 19; 20 x 22mm	397
96 41 05 01	706433 <sup>^</sup>	21/10	6 x 7; 8 x 9; 10 x 11; 12 x 13; 14 x 15; 16 x 17; 18 x 19; 20 x 22; 24 x 27; 30 x 32mm	943

Standard packing: carton

**21TX TORX® ring spanners**

for external TORX® screws, straight,  
Chrome Alloy Steel, chrome plated.

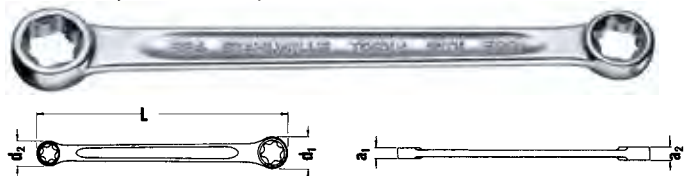

SW Code	Item Code	Size	L mm	d <sub>1</sub> mm	d <sub>2</sub> mm	a <sub>1</sub> mm	a <sub>2</sub> mm	g	
41 25 06 08	706432	E6 x E8	115.5	9.6	11.6	4.5	5.5	17	10
41 25 10 12	706429	E10 x E12	149.5	13.7	15.7	6.5	7.5	33	10
41 25 14 18	706430	E14 x E18	185	17.8	22.5	8	9.5	71	10
41 25 20 24	706431	E20 x E24	227	24.7	29.2	10.5	12.5	129	10

**24 Flare nut spanners, angled**

AS-drive

DIN 3118/ISO 3318 (metric sizes),  
Chrome Alloy Steel, chrome plated.  
Commonly known as Flare Nut Spanners

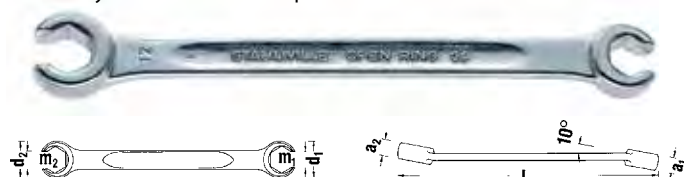

SW Code	Item Code	Size mm	L mm	d <sub>1</sub> mm	d <sub>2</sub> mm	a <sub>1</sub> mm	a <sub>2</sub> mm	m <sub>1</sub> mm	m <sub>2</sub> mm	g
41 08 08 10	706559	8 x 10	145	17.5	19.5	7	8.5	6.3	7.1	39
41 08 09 11	706560	9 x 11	155	18.5	21.5	8.5	9	6.7	8.6	54
41 08 10 11	706546	10 x 11	155	19.5	21.5	8.5	9	7.1	8.6	55
41 08 10 12	706547	10 x 12	160	19.5	22.5	8.5	9.5	7.1	9	59
41 08 11 13	706548	11 x 13	170	21.5	24	9	10	8.6	10	80
41 08 12 14	706549	12 x 14	180	24	26	9.5	10.5	9	11	89

**24a Flare nut spanners, angled**

SW Code	Item Code	Size "	L mm	d <sub>1</sub> mm	d <sub>2</sub> mm	a <sub>1</sub> mm	a <sub>2</sub> mm	m <sub>1</sub> mm	m <sub>2</sub> mm	g
41 48 16 20	706562	1/4 x 3/16	105	16.5	18	5.5	7	3.7	5	32
41 48 20 24	706565	5/16 x 3/8	145	17.5	19.5	7	8.5	6.3	7.1	39
41 48 24 28	706564	3/8 x 7/16	155	19.5	21.5	8.5	9	7.1	8.6	57
41 48 32 34	706561	1/2 x 9/16	180	24	26	9.5	10.5	9.5	11	87

**24 Flare nut spanners, angled**

AS-drive

DIN 3118/ISO 3318 (metric sizes),  
Chrome Alloy Steel, chrome plated.

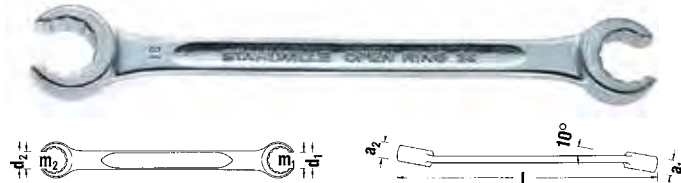

SW Code	Item Code	Size mm	L mm	d <sub>1</sub> mm	d <sub>2</sub> mm	a <sub>1</sub> mm	a <sub>2</sub> mm	m <sub>1</sub> mm	m <sub>2</sub> mm	g
41 08 14 17	706550	14 x 17	200	26	30	10.5	12	11	14	115
41 08 17 19	706552	17 x 19	220	30	33	12	13	14	15.8	151
41 08 19 22	706554	19 x 22	230	33	37	13	15	15.8	17	192
41 08 22 24	706555	22 x 24	245	37	40.5	15	16	17	18	251
41 08 24 27	706556	24 x 27	270	40.5	44.5	16	17.5	18	20	310
41 08 27 36	706557	27 x 36	300	42	54	16	19	20	27	414
41 08 30 32	706558	30 x 32	300	48.5	50.5	20	22	22	24	455

**24a Flare nut spanners, angled**

SW Code	Item Code	Size "	L mm	d <sub>1</sub> mm	d <sub>2</sub> mm	a <sub>1</sub> mm	a <sub>2</sub> mm	m <sub>1</sub> mm	m <sub>2</sub> mm	g
41 48 36 40	706566	5/8 x 3/4	218	29	33	12	13	12.7	15.8	148
41 48 40 48	706563	3/4 x 1	232	33	40.2	13	16	15.8	19	199

**Set: Flare nut spanners No-24**



SW Code	Item Code	No.	Content mm	g
96 83 81 71	706567 <sup>^</sup>	24/7	8 x 10; 10 x 11; 11 x 13; 12 x 14; 14 x 17; 17 x 19; 19 x 22mm	835

**240 Ratchet wrenches FastRatch**

patented, specially suitable for union nuts. Using a single wrench, it is possible to tighten/loosen both metric and imperial nuts and bolts. Made of hardened and tempered stainless steel.

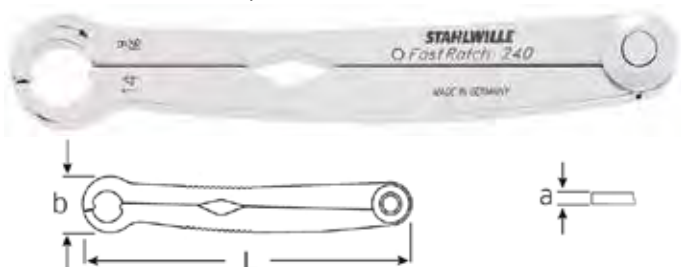

SW Code	Item Code	Size mm/"	L mm	b mm	a mm	g
41 10 08 08	706577 <sup>^</sup>	8 5/16	121.4	16	4	60
41 10 10 10	706568 <sup>^</sup>	10 3/8	133.3	20	4	70
41 10 11 11	706569	11 7/16	140.4	23	5	103
41 10 12 12	706570	12 15/32	146.3	25	5	100
41 10 13 13	706571	13 1/2	168.4	26.8	6	154
41 10 14 14	706572	14 9/16	174.6	29.6	6	180
41 10 16 16	706573	16 5/8	191.3	32.8	7	270
41 10 17 17	706574	17 21/32	201.7	34.3	7	310
41 10 18 18	706575	18 11/16	212.8	36.2	7	310
41 10 19 19	706576	19 3/4	238.5	38.5	7	380

## 240/5 Set: Open-end ratchet wrenches



SW Code	Item Code	No.	Content mm/"	g
96 41 10 01	706578 <sup>^</sup>	240/5	10mm - 3/8"; 11mm - 7/16"; 14mm - 9/16"; 17mm - 21/32"; 19mm - 3/4"	1022

## 25 Ratchet ring spanners

AS-drive

with bi-hexagon, straight, Fed. Spec. GGG-W-001405 (American sizes), chrome plated.



SW Code	Item Code	Ø mm	L mm	d <sub>1</sub> mm	d <sub>2</sub> mm	a mm	g	g	g
41 13 07 08	706586 <sup>^</sup>	7 x 8	109	15	17	9	55	1	1
41 13 09 10	706587 <sup>^</sup>	9 x 10	139	20	23	9	80	1	1
41 13 10 11	706580 <sup>^</sup>	10 x 11	170	26	30	12	144	1	1
41 13 12 13	706581 <sup>^</sup>	12 x 13	170	26	30	12	135	1	1
41 13 14 15	706582 <sup>^</sup>	14 x 15	170	26	30	12	126	1	1
41 13 16 18	706583 <sup>^</sup>	16 x 18	205	33	36	12	196	1	1
41 13 17 19	706584 <sup>^</sup>	17 x 19	205	33	36	12	188	1	1

## 25aN Ratchet ring spanners

as No-25, but made of solid steel.



SW Code	Item Code	Ø "	L mm	d <sub>1</sub> mm	d <sub>2</sub> mm	a mm	g	g	g
41 56 16 20	706591 <sup>^</sup>	1/4 x 5/16	109	15	17	9	65	1	1
41 56 20 22	706594 <sup>^</sup>	5/16 x 11/32	109	15	17	9	60	1	1
41 56 24 28	706593 <sup>^</sup>	3/8 x 7/16	139	20	23	9	90	1	1
41 56 32 34	706590 <sup>^</sup>	1/2 x 9/16	174	26	30	12	164	1	1
41 56 36 38	706595 <sup>^</sup>	5/8 x 11/16	205	33	36	12	257	1	1
41 56 40 44	706592 <sup>^</sup>	3/4 x 7/8	235	36	40	13	296	1	1
41 56 42 46	706610 <sup>^</sup>	13/16 x 15/16	235	36	40	12	281	1	1

## 27 Starter or half moon spanners

AS-drive

ISO 3318, Chrome Alloy Steel, chrome plated.

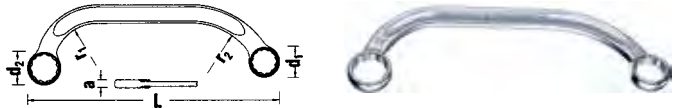

SW Code	Item Code	Ø mm	L mm	d <sub>1</sub> mm	d <sub>2</sub> mm	a mm	r <sub>1</sub> mm	r <sub>2</sub> mm	g	g
41 09 10 12	706625	10 x 12	150	16.5	19.5	6.5	35	60	53	10
41 09 11 13	706626	11 x 13	150	16.5	19.5	6.5	35	60	50	10
41 09 14 16	706627	14 x 16	179	21	24.5	7.5	36	64	91	10
41 09 14 17	706628	14 x 17	179	21	24.5	7.5	36	64	89	10
41 09 15 17	706629	15 x 17	184	22.5	25	7.5	38	66	96	10
41 09 16 18	706630	16 x 18	200	25.3	27.5	8.5	47	68	130	5
41 09 19 22	706631	19 x 22	225	28	32	9	48	67	164	5

## 29 Double ended flexi-joint spanners FLEXI

AS-drive

Chrome Alloy Steel, chrome plated.



SW Code	Item Code	Ø mm	L mm	d <sub>1</sub> mm	d <sub>2</sub> mm	a <sub>1</sub> mm	a <sub>2</sub> mm	g	g
43 01 08 09	706652	8 x 9	201	11.9	13.4	26	27.5	81	10
43 01 10 11	706636 <sup>^</sup>	10 x 11	202	14.7	15.9	30.5	32	102	10
43 01 10 13	706637	10 x 13	230.5	14.7	18.4	30	33.5	137	10
43 01 12 13	706638	12 x 13	228	17.2	18.4	33	33.5	153	10
43 01 14 15	706641	14 x 15	227	19.7	20.9	35	37	197	10
43 01 16 17	706642 <sup>^</sup>	16 x 17	247	22.2	23.7	38.5	39	234	10
43 01 16 18	706643	16 x 18	249	22.2	24.7	38.5	40	267	10
43 01 17 19	706644	17 x 19	250	23.7	26.3	39	41	277	5
43 01 18 19	706645	18 x 19	246.5	24.7	26.3	40	41	294	5
43 01 20 22	706647	20 x 22	287.5	27.3	29.8	45.5	48	430	5
43 01 21 23	706648	21 x 23	286.5	28.6	31.1	46.5	50	447	5
43 01 24 27	706649	24 x 27	349.5	32.4	36.1	50.5	60.5	716	5

## 29a Double ended flexi-joint spanners FLEXI

SW Code	Item Code	Ø "	L mm	d <sub>1</sub> mm	d <sub>2</sub> mm	a <sub>1</sub> mm	a <sub>2</sub> mm	g	g
43 41 24 28	706654	3/8 x 7/16	202	14	16	30.5	32	98	5
43 41 32 34	706653	1/2 x 9/16	227	18.1	20	35	37	195	5
43 41 36 38	706655	5/8 x 11/16	249.5	22.1	24	39	40	269	5

## 29/7 Set: Double ended flexi-joint spanners FLEXI



SW Code	Item Code	No.	Content mm/"	g
96 43 01 01	706656	29/7	8 x 9; 10 x 11; 12 x 13; 14 x 15; 16 x 17; 18 x 19; 20 x 22mm	1503

Standard packing: carton

### 4004 Single-end spanners

DIN 894, Special Tool Steel, grey finish.



SW Code	Item Code	Ø mm	L mm	b mm	a mm	g	⚖	📦
40 04 02 40	706846 <sup>^</sup>	24	215	50	8.9	147	1	
40 04 02 70	706847 <sup>^</sup>	27	238	56	9.8	193	1	
40 04 03 00	706848	30	261	62	10.8	268	1	
40 04 03 20	706849	32	273	66	11.8	315	1	
40 04 03 60	706850	36	300	74	12.8	421	1	
40 04 04 10	706851	41	335	83.5	12.8	555	1	
40 04 04 60	706852	46	369	93	14.8	770	1	
40 04 05 00	706853	50	412	102	17	1003	1	
40 04 05 50	706854	55	457	112	18	1267	1	
40 04 06 00	706855	60	492	122	18	1650	1	
40 04 06 50	706856	65	528	132	19	2012	1	
40 04 07 00	706857	70	572	142	20	2425	1	
40 04 07 50	706858	75	608	152	21	2758	1	
40 04 08 00	706859 <sup>^</sup>	80	645	162	22	2963	1	
40 04 08 50	706860 <sup>^</sup>	85	690	173	23	3717	1	
40 04 09 00	706861 <sup>^</sup>	90	690	173	23	3570	1	
40 04 09 50	706862 <sup>^</sup>	95	847	195	25	5943	1	

### 10750 Box spanners

DIN 896, B shape, ST 55, tubular, high carbon alloy steel, seamless drawn, chrome plated.

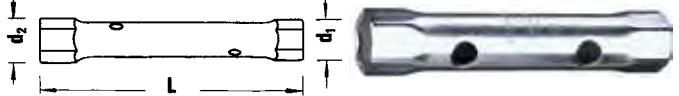

SW Code	Item Code	Ø mm	L mm	d <sub>1</sub> mm	d <sub>2</sub> mm	g	⚖	📦
43 32 06 07	705245 <sup>^</sup>	6 x 7	110	7.52	10.5	26	10	
43 32 08 09	705246 <sup>^</sup>	8 x 9	110	12.2	13.2	30	10	
43 32 10 11	705229 <sup>^</sup>	10 x 11	120	14.2	15.2	48	10	
43 32 12 13	705230	12 x 13	140	17.2	18.2	68	10	
43 32 14 15	705231 <sup>^</sup>	14 x 15	140	19.2	20.2	78	10	
43 32 16 17	705232 <sup>^</sup>	16 x 17	150	22.2	23.2	123	10	
43 32 17 19	705233 <sup>^</sup>	17 x 19	160	24.2	26.2	147	10	
43 32 18 19	705234 <sup>^</sup>	18 x 19	160	25.2	26.2	148	10	
43 32 20 22	705235 <sup>^</sup>	20 x 22	170	27.2	29.3	200	5	
43 32 21 23	705236 <sup>^</sup>	21 x 23	170	28.2	30.2	191	5	
43 32 24 26	705237 <sup>^</sup>	24 x 26	190	32.2	34.2	293	5	
43 32 24 27	705238 <sup>^</sup>	24 x 27	190	32.2	35.2	289	5	
43 32 30 32	705239 <sup>^</sup>	30 x 32	200	39.2	42.3	382	5	
43 32 32 36	705240 <sup>^</sup>	32 x 36	220	42.2	46.2	535	2	
43 32 36 41	705241 <sup>^</sup>	36 x 41	220	47.2	52.5	662	2	
43 32 41 46	705242 <sup>^</sup>	41 x 46	240	53.2	59.2	750	2	
43 32 46 50	705243 <sup>^</sup>	46 x 50	240	58.5	63.5	959	2	
43 32 55 60	705244 <sup>^</sup>	55 x 60	240	70.2	76.2	1125	2	

### 4025 Single-end spanners, adjustable

right-handed, DIN 3117/ISO 6787, B shape, jaw offset 22°, Chrome Vanadium, chrome plated.

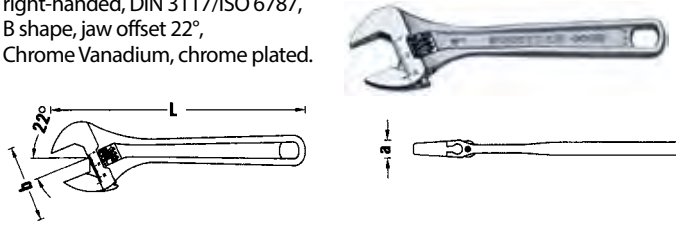

SW Code	Item Code	Size	Ø max mm	L mm	b mm	a mm	g	⚖	📦
40 25 00 04	706887	4	13	114	33	9.5	53	5	
40 25 00 06	706888	6	20	159	48	12	123	5	
40 25 00 08	706889	8	24	206	60	13.5	241	5	
40 25 00 10	706883	10	29	257	71	16	399	5	
40 25 00 12	706884	12	34	309	83	19	708	5	
40 25 00 15	706885	15	43	384	103	25	1287	1	
40 25 00 18	706886	18	53	460	120	30	2105	1	



### Sets: Box spanners

SW Code	Item Code	No.	Content mm	g
96 43 12 01	705248 <sup>^</sup>	10750/7	8 x 9; 10 x 11; 12 x 13; 14 x 15; 16 x 17; 18 x 19; 20 x 22mm	725
96 43 12 04	705247 <sup>^</sup>	10750/11	6 x 7; 8 x 9; 10 x 11; 12 x 13; 14 x 15; 16 x 17; 18 x 19; 20 x 22; 21 x 23; 24 x 27; 30 x 32mm	1585

### 4026 Single-end spanners, adjustable

left-handed, DIN 3117/ISO 6787, A shape, jaw offset 15°, Chrome-Vanadium, gun finish.

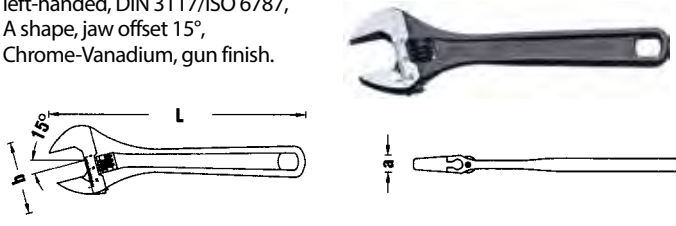

SW Code	Item Code	Size	Ø max mm	L mm	b mm	a mm	g	⚖	📦
40 26 00 04	706894 <sup>^</sup>	4	13	114	33	9.5	50	5	
40 26 00 06	706895 <sup>^</sup>	6	20	159	48	12	138	5	
40 26 00 08	706896 <sup>^</sup>	8	24	206	60	13.5	247	5	
40 26 00 10	706890 <sup>^</sup>	10	29	257	71	16	397	5	
40 26 00 12	706891 <sup>^</sup>	12	34	309	83	19	699	5	
40 26 00 15	706892 <sup>^</sup>	15	43	384	103	25	1324	1	
40 26 00 18	706893 <sup>^</sup>	18	53	460	120	30	2076	1	

## 4205 Flogging Spanners - Metric

Striking Face Ring Spanner



SW Code	Item Code	Ø mm	No.	
42 05 00 24	707037 <sup>^</sup>	24	SW4205 24	1
42 05 00 26	707038 <sup>^</sup>	26	SW4205 26	1
42 05 00 27	707039	27	SW4205 27	1
42 05 00 28	707040 <sup>^</sup>	28	SW4205 28	1
42 05 00 30	707041 <sup>^</sup>	30	SW4205 30	1
42 05 00 32	707042 <sup>^</sup>	32	SW4205 32	1
42 05 00 33	707043 <sup>^</sup>	33	SW4205 33	1
42 05 00 36	707044 <sup>^</sup>	36	SW4205 36	1
42 05 00 37	707045 <sup>^</sup>	37	SW4205 37	1
42 05 00 38	707046 <sup>^</sup>	38	SW4205 38	1
42 05 00 41	707047 <sup>^</sup>	41	SW4205 41	1
42 05 00 42	707048 <sup>^</sup>	42	SW4205 42	1
42 05 00 46	707049	46	SW4205 46	1
42 05 00 47	707050 <sup>^</sup>	47	SW4205 47	1
42 05 00 48	707051 <sup>^</sup>	48	SW4205 48	1
42 05 00 50	707052	50	SW4205 50	1

SW Code	Item Code	Ø mm	No.	
42 05 00 52	707053 <sup>^</sup>	52	SW4205 52	1
42 05 00 55	707054	55	SW4205 55	1
42 05 00 56	707055	56	SW4205 56	1
42 05 00 60	707056 <sup>^</sup>	60	SW4205 60	1
42 05 00 64	707057 <sup>^</sup>	64	SW4205 64	1
42 05 00 65	707058	65	SW4205 65	1
42 05 00 70	707059 <sup>^</sup>	70	SW4205 70	1
42 05 00 75	707060 <sup>^</sup>	75	SW4205 75	1
42 05 00 80	707061 <sup>^</sup>	80	SW4205 80	1
42 05 00 85	707062 <sup>^</sup>	85	SW4205 85	1
42 05 00 90	707063 <sup>^</sup>	90	SW4205 90	1
42 05 00 95	707064 <sup>^</sup>	95	SW4205 95	1
42 05 01 00	707022 <sup>^</sup>	100	SW4205 100	1
42 05 01 05	707023 <sup>^</sup>	105	SW4205 105	1
42 05 01 10	707024 <sup>^</sup>	110	SW4205 110	1
42 05 01 15	707025 <sup>^</sup>	115	SW4205 115	1
42 05 01 20	707026 <sup>^</sup>	120	SW4205 120	1
42 05 01 30	707027 <sup>^</sup>	130	SW4205 130	1
42 05 01 35	707028 <sup>^</sup>	135	SW4205 135	1
42 05 01 45	707029 <sup>^</sup>	145	SW4205 145	1
42 05 01 50	707030 <sup>^</sup>	150	SW4205 150	1
42 05 01 60	707031 <sup>^</sup>	160	SW4205 160	1
42 05 01 65	707032 <sup>^</sup>	165	SW4205 165	1
42 05 01 70	707033 <sup>^</sup>	170	SW4205 170	1
42 05 01 75	707034 <sup>^</sup>	175	SW4205 175	1
42 05 01 80	707035 <sup>^</sup>	180	SW4205 180	1
42 05 02 10	707036 <sup>^</sup>	210	SW4205 210	1

## Tool sets for the aerospace industry



For maintenance on aeroplanes and helicopters.

All of our Stahlwille tool sets for the aerospace industry come with the Tool Control System for built in safety. The QuickRelease System for socket spanners and inserts has a safety lock to prevent damage to workpieces and guarantee secure, rapid connection of all components to form a single combined unit, so you can't inadvertently release a tool. This combined with our Anti Slip Drive and High Performance Quality Steel ensure you have the best tools for the job. Contact Customer Service on 1300 780 876 for more information and to enquire about the range of tool sets available.



## Provide guaranteed safety and efficiency. STAHLWILLE sets of socket spanners and inserts

The professionals in industry and the trades are under pressure to work quickly, accurately and economically. Which is why they make heavy demands on their tools. Due to the numerous technical innovations incorporated in them, STAHLWILLE ratchets and sockets make a valuable contribution to the prevention of both mistakes and injuries.

By using ratchets, adaptors and inserts made by STAHLWILLE, professional tradesmen are quite simply "making sure". It does not matter whether it is a full set of tools or individual components – users can be sure they will get top-of-the-range quality every time. This is guaranteed by adherence to the closest tolerances during production and stringently applied quality assurance measures in accordance with DIN EN ISO 9001. The legendary reliability and precision of these tools is enhanced by a large number of user-friendly features.



Set No 45/14/5iQR  
in sturdy plastic case

- Non-slip, ergonomically manufactured 2-component handles facilitate strain-free working.
- Slim-design sockets enable access to awkward places.
- The QuickRelease system ensures full control over the joint between the ratchet, the adaptors and the sockets.
- Sculpted chemical-resistant cut-outs in special PE foam inlays prevent tools rattling and sliding around.



- 1** Ergonomically designed 2-component handle made of impact-resistant, skydrol resistant plastic.
- 2** All metal parts are made of high-grade steel (Chrome Alloy Steel, chrome plated).
- 3** Firm seating and yet easy release of sockets and adaptors.
- 4** Wear parts can be easily replaced using sets of spares for sockets.
- 5** Separate pawl to switch from clockwise to anti-clockwise.







**Safety advantage 1**  
STAHLWILLE QuickRelease system

The problem: imagine what happens if a tool falls into an inaccessible place during repair or overhaul work.

The consequences: arduous, costly search and recovery, possibly involving disassembly of an aeroengine or machine.

The solution: the safety lock built into the QuickRelease system prevents damage to workpieces and guarantees secure, rapid connection of all individual components to form a single combined unit. Nothing can get lost because it is not possible to inadvertently release a tool. To release a tool, it is first necessary to press the release button deliberately. Even if you have oily or greasy hands, attaching and separating the individual components is so simple it noticeably smoothes your workflows.

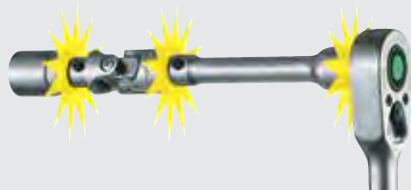

**Safety advantage 2**  
STAHLWILLE AS-Drive

The problem: removing heavily corroded screws requires the application of considerable force. The socket slips off the head of the screw.

The consequences: uncontrolled movements cause injuries and damage to both the workpiece and the tools.

The solution: STAHLWILLE sockets are equipped with the AS-Drive\* profile. This permits high transmission of forces to the lands of nuts and bolts without damaging them. The risk of injury is minimised and the corners of the screw heads and nuts are no longer damaged.

\*AS-Drive = Anti-Slip-Drive

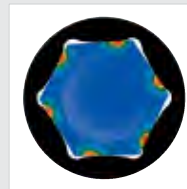

**Safety advantage 3**  
STAHLWILLE HPQ®-inserts

The problem: although there is hardly enough room to move, you still have to apply considerable torque to loosen a stubborn screw.

The consequences: many of the sockets available are useless simply because their wall thickness makes them impracticable in awkward places.

The solution: STAHLWILLE HPQ®-sockets are manufactured from selected tough steel alloys. These sockets will not slip off the head of the screw, nor will they stretch when subjected to heavy loads. Their extremely thin walls and unbelievably high load capacity are simply exemplary. HPQ®-sockets are free of cadmium and are therefore suitable for use on titanium alloy parts and titanium fasteners as used e.g. in the aerospace industry, where safety is a crucial factor. They meet these aerospace standards: E DIN EN 3709, E DIN EN 3710, SAE AS 954-E, S.B.A.C. AS 40605/40606, MS-33787, MIL-W-8982.

\* = High Performance Quality



Some sets of STAHLWILLE socket spanners are supplied in sturdy plastic cases.







# 1/4" Drive Sockets and Tools

## 44P Screwdriver sockets

for recessed head screws Phillips-Recess®, tips to DIN 5260, Chrome Alloy Steel, chrome plated.

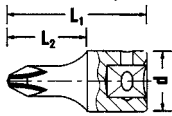

SW Code	Item Code	PH Size	L <sub>1</sub> mm	L <sub>2</sub> mm	d mm	△△ g	
01 29 00 01	707228 <sup>^</sup>	1	28	16	11.6	10	5
01 29 00 02	707229 <sup>^</sup>	2	28	16	11.6	11	5
01 29 00 03	707230 <sup>^</sup>	3	28	16	11.6	12	5
01 29 00 04	707231 <sup>^</sup>	4	28	16	11.6	14	5

## 40CL Clip strips

for socket retention, with 9 or 10 retaining clips. Supplied without sockets.



SW Code	Item Code	Size	L mm	△△ g	
80 40 00 01	706777 <sup>^</sup>	1	200	36	5
80 40 00 02	706778 <sup>^</sup>	2	300	52	5

## Drive tools and accessories

1/4" □, finish: Chrome Alloy Steel, chrome plated.

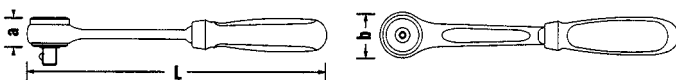

## 415 Ratchet

reversible (22 teeth), with 2-component handle DIN 3122/ISO 3315.



SW Code	Item Code	L mm	b mm	a mm	△△ g	
11 11 10 10	706977	117	22	12.5	80	5

## 415QR QuickRelease ratchet



reversible (22 teeth), with QuickRelease safety lock and 2-component handle, DIN 3122/ISO 3315.



SW Code	Item Code	L mm	b mm	a mm	△△ g	
11 11 00 20	706990	117	22	12.5	79	1

## QR The QuickRelease system

Ratchets, handles, extensions, universal joints with safety locks.

Secure, rapid connection between the individual components to form a single combined unit.

Can only be separated by releasing the locking mechanism.

Variable combinations of components possible.



## 415SG-QR Ratchet



reversible (22 teeth), with QuickRelease safety lock and steel handle, DIN 3122/ISO 3315.



SW Code	Item Code	L mm	b mm	a mm	△△ g	
11 11 00 30	706993	117	22	12.5	90	1

## 416 Flexible joint ratchet

reversible (60 teeth), handle may be raised or lowered by approx. 90°. Lockable in following positions: straight, 30° up, 60° up, 30° down. Unlocked by depressing button in handle, registered design.



SW Code	Item Code	L mm	b mm	a mm	△△ g	
11 26 00 01	706995 <sup>^</sup>	170	25	19.5	237	1

## Spare parts for ratchets No-415, 415SK, 415SG

### 4150 Spare parts set

- Content:
- 1 Pinion
- 1 Pawl
- 1 Lever with pin
- 1 Ball
- 2 Compression Springs
- 2 Screws M 1.7 x 8
- 1 Cover plate

SW Code	Item Code	△△ g	
19 01 00 00	706981	26	1

# 1/4" Drive Sockets and Tools

## Spare parts for ratchets No-415QR, 415SG-QR

### 4150 QR Spare parts set



Content:  
1 Pinion  
1 Pawl  
2 Levers with pin  
1 Ball  
2 Compression Springs  
2 Screws M 1.7 x 8  
1 Cover plate

SW Code	Item Code	⚖️ g	📦
19 01 10 20	706986	19	1

### 400N Drive handle

DIN 3122/ISO 3315.



SW Code	Item Code	L mm	⚖️ g	📦
11 05 00 10	706868	150	70	5

### 400QR QuickRelease drive handle



DIN 3122/ISO 3315,  
with QuickRelease safety lock,  
patent



SW Code	Item Code	L mm	⚖️ g	📦
11 05 10 10	706842 <sup>^</sup>	150	80	1

### 403N Flexible handle

DIN 3122/ISO 3315.  
with 2-component handle.



SW Code	Item Code	L mm	⚖️ g	📦
11 06 10 10	706901 <sup>^</sup>	154.5	70	1

### 404 Sliding T-handle

DIN 3122/ISO 3315.



SW Code	Item Code	L mm	⚖️ g	📦
11 07 00 00	706902	116	38	5

### 413 Speeder brace

with steel handle, for greater axial  
power transmission, detachable palm  
head, working radius 70-mm.



SW Code	Item Code	L mm	⚖️ g	📦
11 10 00 01	706973	440	352	1

### 405 Extensions

DIN 3123/ISO 3316.

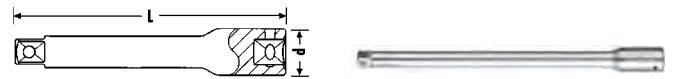

SW Code	Item Code	Size	L mm	d mm	⚖️ g	📦
11 01 00 01	706915	2	54	11.6	29	5
11 01 00 06	706918	4	100	11.6	46	5
11 01 00 02	706920	6	150	11.6	65	5
11 01 00 10	706910	10	254	11.6	115	1
11 01 00 14	706912	14	356	11.6	155	1

### Extensions with wobble-drive

swivel angle 8°  
each side,  
max. torque 40 N m.



SW Code	Item Code	No.	L mm	d mm	⚖️ g	📦
11 01 00 11	706917	405/2W	54	11.6	28	1
11 01 00 16	706919	405/4W	100	11.6	45	1
11 01 00 12	706922	405/6W	150	11.6	55	1
11 01 00 20	706911	405/10W	254	11.6	110	1
11 01 00 24	706914	405/14W	356	11.6	155	1

### QuickRelease extensions



patent, DIN 3123/ISO 3316.



SW Code	Item Code	No.	L mm	d mm	⚖️ g	📦
11 01 10 01	706916 <sup>^</sup>	405/2QR	54	11.6	28	1
11 01 10 02	706921 <sup>^</sup>	405/6QR	150	11.6	65	1

### 406 Extension, flexible

(right hand rotation only)  
maximum torque 5 N m.



SW Code	Item Code	L mm	d mm	⚖️ g	📦
11 04 00 00	706930	152	11.6	61	5

### 407 Universal joint

DIN 3123/ISO 3316.



SW Code	Item Code	L mm	d mm	⚖️ g	📦
11 02 00 00	706932	37	12.8	23	5

# 1/4" Drive Sockets and Tools

## 409 Adaptor



1/4" socket x 3/8" plug  
(6.3 X 10mm),  
DIN 3123/ISO 3316,  
HPQ® high performance steel.



SW Code	Item Code	L mm	d mm	ΔΔ g	☐
11 03 00 02	706934	25	12.8	18	5

## 410 Adaptor



1/4" socket x 1/2" plug  
(6.3 x 12.5mm),  
HPQ® high performance steel.



SW Code	Item Code	L mm	d mm	ΔΔ g	☐
11 03 00 03	706966	28	16.5	36	5

## 412 Bit holder



1/4" inside hexagon,  
DIN 3126/ISO 1173 form D 6.3.  
Internal hex drive with a collar-thrust spring. Bits are easy to insert, lock securely in position and can be removed just as easily; even hex bits with a wide groove (Type E, DIN 3126/ISO 1173).  
HPQ® high performance steel



SW Code	Item Code	L mm	d mm	ΔΔ g	☐
11 18 00 10	706972 <sup>^</sup>	25	11.6	15	5

## 4008 Ratcheting bit holder

Positions selectable are clockwise/counterclockwise/fixed with fixed blade. Inner hex. with magnet, for 1/4" screwdriver bits with outside hexagon 1/4" DIN 3126/ISO 1173 C 6.3.

The square drive extension No-3115/1 can be used to adapt 1/4" socket inserts (outer hex. to 1/4" outer square).

The ratcheting bit holder is fitted with a quick-twist knurled socket to allow the user to tighten or untighten loosely by hand. Socket mountings are toothed, heavy-duty and angled at 30°. Ergonomically shaped handle with 1/4" inner square drive, for use with cross-handle, extension bar etc.

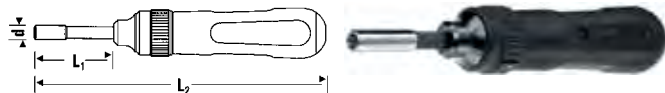

SW Code	Item Code	inside O	"	L <sub>1</sub> mm	L <sub>2</sub> mm	d mm	ΔΔ g	☐
18 12 00 00	706866 <sup>^</sup>	D 6.3	1/4	56	206.5	10	185	8

inside O DIN 3126/ISO 1173

## 415SGH Ratchet for Hi-Lok bolts

reversible, patented, axially drilled pinion, locking facility for sockets. For use on Hi-Lok bolts in the aerospace industry (22 teeth)



SW Code	Item Code	L mm	b mm	a mm	ΔΔ g	☐
11 11 00 02	706979 <sup>^</sup>	117	22	12.5	90	5

## STAHLWILLE AS-Drive

STAHLWILLE sockets are equipped with the AS Drive\* profile: this permits high transmission of forces to the lands of nuts and bolts without damaging them. No longer will you have to worry about stripping the corners off nuts and bolts.

\*Anti-Slip Drive

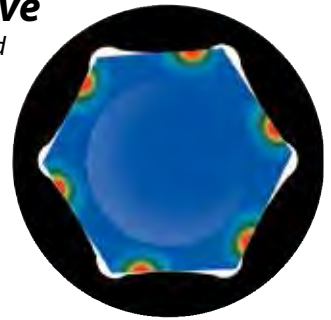

## 40D/9/4 Socket set 1/4" ☐

In sturdy sheet steel case

13 pieces

Content:

- 9 sockets with bi-hexagon No 40D: sizes 4; 5; 5.5; 6; 7; 8; 10; 11; 13 mm
- 1 ratchet No 415
- 2 extensions No 405/2 (54 mm), No 405/6 (150 mm)
- 1 universal joint No 407



SW Code	Item Code	ΔΔ g
96 01 03 04	706956 <sup>^</sup>	852

## 40ma/25/8 Socket set 1/4" ☐

In sturdy sheet steel case,

33 pieces

Content:

- 25 sockets with hexagon No-40: sizes 3.2; 3.5; 4; 4.5; 5; 5.5; 6; 7; 8; 9; 10; 11; 12; 13; 14-mm
- No-40a: sizes 3/16; 7/32; 1/4; 9/32; 5/16; 11/32; 3/8; 7/16; 1/2; 9/16"
- 1 ratchet No-415
- 2 extensions No-405/2 (54-mm), No-405/6 (150-mm)
- 1 extension, flexible No-406 (152-mm)
- 1 universal joint No-407
- 1 drive handle No-400
- 1 flexible handle No-403
- 1 T-handle No-404



SW Code	Item Code	ΔΔ g
96 01 01 62	706958 <sup>^</sup>	2050

## SW40D/40AD/18/5TCS Socket set 1/4" ☐



In plastic case with TCS foam, all 12pt sockets  
23 pieces

Content:

- No-40: sizes 5, 6, 7, 8, 9, 10, 11, 12, 13mm Sockets
- No-40a: sizes 3/16; 7/32; 1/4; 9/32; 5/16; 11/32; 3/8; 7/16; 1/2" Sockets

Plus:

- 1 ratchet 415qr
- 2 extensions 405/2qr (52-mm), 405/6qr (150-mm)
- 1 universal joint 407qr
- 1 drive handle 400qr



SW Code	Item Code
91 22 82 14	706955





# 3/8" Drive Sockets and Tools

## 4606 Spark plug socket



extra deep, with rubber insert,  
HPQ® high performance steel, chrome plated.



SW Code	Item Code	⌀ mm/"	d <sub>1</sub> mm	d <sub>2</sub> mm	L mm	t <sub>1</sub> mm	t <sub>2</sub> mm	⚖ g	📦
02 13 00 18	707470 <sup>△</sup>	18-11/16	24.2	22	65	18	52.8	132	10

Assembly of spark plugs on motorcycles, mopeds

## 45TX/7 Set: Sockets



for external TORX® screws.  
Content:  
E5; E6; E7; E8; E10; E12; E14



SW Code	Item Code	⚖ g	📦
96 02 27 02	707435	219	1

in carton packing

## 49 INHEX sockets

for socket head screws, DIN 7422,  
Chrome Alloy Steel, chrome plated.



SW Code	Item Code	⌀ mm	L <sub>1</sub> mm	L <sub>2</sub> mm	d mm	⚖ g	📦
02 05 00 03	707761	3	52	20	17.8	38	5
02 05 00 04	707762	4	52	20	17.8	40	5
02 05 00 05	707763	5	52	20	17.8	44	5
02 05 00 06	707764	6	52	20	17.8	46	5
02 05 00 07	707765	7	52	20	17.8	51	5
02 05 00 08	707766	8	52	20	17.8	55	5
02 05 00 10	707760	10	52	20	17.8	62	5

## 49a INHEX sockets

SW Code	Item Code	⌀ "	L <sub>1</sub> mm	L <sub>2</sub> mm	d mm	⚖ g	📦
02 45 00 08	707768	1/8	52	20	17.8	40	5
02 45 00 09	707774 <sup>△</sup>	9/64	52	20	17.8	40	5
02 45 00 10	707772	5/32	52	20	17.8	40	5
02 45 00 12	707769	3/16	52	20	17.8	44	5
02 45 00 14	707773	7/32	52	20	17.8	46	5
02 45 00 16	707767	1/4	52	20	17.8	48	5
02 45 00 20	707771	5/16	52	20	17.8	55	5
02 45 00 24	707770	3/8	52	20	17.8	61	5

## 2049 INHEX sockets

for socket head screws,  
extra long, DIN 7422,  
Chrome Alloy Steel, chrome plated.



SW Code	Item Code	⌀ mm	L <sub>1</sub> mm	L <sub>2</sub> mm	d mm	⚖ g	📦
02 15 10 04	706392	4	100	68	17.8	45	5
02 15 10 05	706393	5	100	68	17.8	50	5
02 15 10 06	706394	6	100	68	17.8	57	5
02 15 12 08	706395 <sup>△</sup>	8	120	88	17.8	85	5
02 15 12 10	706391	10	120	88	17.8	106	5

## 49TX Screwdriver sockets

for inside TORX® screws,  
Chrome Alloy Steel, chrome plated.



SW Code	Item Code	Size	⌀ mm	L <sub>1</sub> mm	L <sub>2</sub> mm	d mm	⚖ g	📦
02 10 00 09	707784	T9	2.5	49	17	17.8	45	5
02 10 00 10	707776	T10	2.7	49	17	17.8	45	5
02 10 00 15	707777	T15	3.3	49	17	17.8	45	5
02 10 00 20	707778	T20	3.8	49	17	17.8	46	5
02 10 00 25	707779	T25	4.4	49	17	17.8	46	5
02 10 00 27	707780	T27	5	49	17	17.8	46	5
02 10 00 30	707781	T30	5.5	49	17	17.8	47	5
02 10 00 40	707782	T40	6.6	49	17	17.8	48	5
02 10 00 45	707783	T45	7.8	49	17	17.8	49	5

## 49TX/8 Set: Screwdriver sockets

for inside TORX® screws.  
Content: T9; T10; T15; T20; T25; T27; T30; T40



SW Code	Item Code	⚖ g	📦
96 02 10 01	707775	456	1

in carton packing

## 49X Screwdriver sockets

for tri-square socket head screws (XZN®), DIN 2324,  
Chrome Alloy Steel, chrome plated.



SW Code	Item Code	Size	L <sub>1</sub> mm	L <sub>2</sub> mm	d mm	⚖ g	📦
02 06 00 05	707786	M5	52	20	17.8	45	5
02 06 00 06	707787	M6	52	20	17.8	47	5
02 06 00 08	707788	M8	52	20	17.8	56	5
02 06 00 10	707785	M10	52	20	17.8	63	5



# 3/8" Drive Sockets and Tools

## 540 CROW-FOOT spanners

Caution! Modified settings on torque wrench (refer to note on page 196), Chrome Alloy Steel, chrome plated.

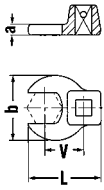

SW Code	Item Code	mm	"	L mm	b mm	a mm	V mm	g	
01 20 00 08	708198 <sup>^</sup>	8	1/4	25.5	19.8	6.3	14.8	21	1
01 20 00 09	708199 <sup>^</sup>	9	1/4	25.5	19.8	6.3	14.6	21	1
01 20 00 10	708170 <sup>^</sup>	10	1/4	25.5	19.8	6.3	14.6	20	1
02 20 00 11	708171 <sup>^</sup>	11	3/8	32	22.2	6.3	17.4	36	1
02 20 00 12	708172 <sup>^</sup>	12	3/8	34.3	25.4	6.3	18.2	37	1
02 20 00 13	708173 <sup>^</sup>	13	3/8	34.3	25.4	6.3	17.8	36	1
02 20 00 14	708174 <sup>^</sup>	14	3/8	37.7	30	6.3	20.8	46	1
02 20 00 15	708175 <sup>^</sup>	15	3/8	37.7	30	6.3	20.4	45	1
02 20 00 16	708176 <sup>^</sup>	16	3/8	37.7	30	6.3	19.9	45	1
02 20 00 17	708177 <sup>^</sup>	17	3/8	42.5	38	6.3	23.8	62	1
02 20 00 18	708178 <sup>^</sup>	18	3/8	42.5	38	6.3	22.9	61	1
02 20 00 19	708179 <sup>^</sup>	19	3/8	42.5	38	6.3	22.5	64	1
02 20 00 20	708180 <sup>^</sup>	20	3/8	42.5	38	6.3	25	55	1
02 20 00 21	708181 <sup>^</sup>	21	3/8	44.5	41	6.3	23.6	59	1
02 20 00 22	708182 <sup>^</sup>	22	3/8	44.5	41	6.3	24.2	64	1
02 20 00 23	708183 <sup>^</sup>	23	3/8	44.5	41	6.3	25.6	63	1
02 20 00 24	708184 <sup>^</sup>	24	3/8	44.5	41	6.3	26.2	60	1
02 20 00 25	708185 <sup>^</sup>	25	3/8	47	45	8	26.4	75	1
02 20 00 26	708186 <sup>^</sup>	26	3/8	47	45	8	27.6	80	1
02 20 00 27	708187 <sup>^</sup>	27	3/8	47	45	8	27.6	76	1
02 20 00 28	708188 <sup>^</sup>	28	3/8	50	50	8	29.3	78	1
02 20 00 30	708189 <sup>^</sup>	30	3/8	50	50	8	29.3	84	1
02 20 00 32	708190	32	3/8	53	57	8	30.5	95	1
02 20 00 34	708191 <sup>^</sup>	34	3/8	54.5	60	8	31.6	107	1
02 20 00 36	708192	36	3/8	56.5	62	8	32.8	100	1
02 20 00 40	708193 <sup>^</sup>	40	3/8	63	70	8	37.6	130	1
02 20 00 41	708194 <sup>^</sup>	41	3/8	63	70	8	37.2	130	1
02 20 00 42	708195 <sup>^</sup>	42	3/8	63	70	8	37.8	125	1
02 20 00 46	708196 <sup>^</sup>	46	3/8	72	82	8	43.1	191	1
02 20 00 50	708197 <sup>^</sup>	50	3/8	75	88	8	45.4	217	1

## 45CL Clip strips

for socket retention, with 9 or 10 retaining clips. Supplied without sockets.



SW Code	Item Code	Size	L mm	g	
80 45 00 01	707352	1	200	40	5
80 45 00 02	707353 <sup>^</sup>	2	300	58	5

## Drive tools and accessories

3/8" finish: Chrome Alloy Steel, chrome plated.

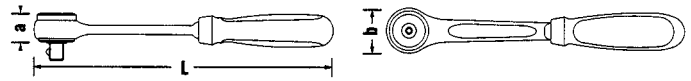

### 422N Ratchet

fine tooth, reversible, 60 teeth, with 2-component handle, for use in confined spaces, re-engages after movement of 6°, DIN 3122/ISO 3315.



SW Code	Item Code	L mm	b mm	a mm	g	
12 23 10 11	707106 <sup>^</sup>	194	32	24	236	1

### 435N Ratchet

reversible, 30 teeth, with 2-component handle, DIN 3122/ISO 3315.



SW Code	Item Code	L mm	b mm	a mm	g	
12 11 10 10	707189	193	29	17.9	245	5

### 435QR QuickRelease ratchet



reversible, 30 teeth, with QuickRelease safety lock and 2-component handle, DIN 3122/ISO 3315.



SW Code	Item Code	L mm	b mm	a mm	g	
12 11 00 20	707190	193	29	17.9	244	1

## QR The QuickRelease system

Ratchets, handles, extensions, universal joints with safety locks.

Secure, rapid connection between the individual components to form a single combined unit.

Can only be separated by releasing the locking mechanism.

Variable combinations of components possible.



# 3/8" Drive Sockets and Tools

## 435SG-QR Ratchet



reversible, 30 teeth, with QuickRelease safety lock and steel handle, DIN 3122/ISO 3315.



SW Code	Item Code	L mm	b mm	a mm	△△ g	
12 11 00 30	707192 <sup>^</sup>	193	29	17.9	275	1

## 452 Flexible joint ratchet

reversible, 60 teeth, handle may be raised or lowered by approx. 90°. Lockable in following positions: straight, 30° up, 60° up, 30° down. Unlocked by depressing button in handle, registered design.



SW Code	Item Code	L mm	b mm	a mm	△△ g	
12 26 00 01	707393	300	34	24	505	1

## Spare parts for ratchets No-422, 452

### 7350/5 Spare parts set

Content:  
1 Pinion  
1 Pawl  
1 Switching disk  
1 Spring  
3 Screws

SW Code	Item Code	△△ g	
59 25 10 05	709095	85	1

for ratchets from 12/97

## Spare parts for ratchets No-435, 435SG, 438, 439

### 4350 Spare parts set

Content:  
1 Pinion  
1 Pawl  
1 Lever with pin  
1 Ball  
2 Compression Springs  
2 Screws

SW Code	Item Code	△△ g	
19 02 00 00	707179	50	1

for ratchets from 1992

## Individual Spare Parts

SW Code	Item Code	
SW4350 D	707180 <sup>^</sup>	Pinion only
SW4350 SCH	707186 <sup>^</sup>	Screw only

## Spare parts for ratchets No-435QR, 435SG-QR

### 4350 QR Spare parts set



Content:  
1 Pinion  
1 Pawl  
1 Lever with pin  
1 Ball  
2 Compression Springs  
2 Screws

SW Code	Item Code	△△ g	
19 02 00 20	707183	51	1

### 424 Flexible handle

DIN 3122/ISO 3315.  
with 2-component handle



SW Code	Item Code	L mm	△△ g	
12 06 10 10	707107	253.5	222	1

### 425 Sliding T-handle

DIN 3122/ISO 3315.



SW Code	Item Code	L mm	△△ g	
12 07 00 00	707108	165	133	5

### 427 Extensions

DIN 3123/ISO 3316.

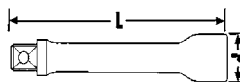

SW Code	Item Code	Size	L mm	d mm	△△ g	
12 01 00 05	707110	1.5	38	17	36	5
12 01 00 01	707114	3	76	17	67	5
12 01 00 06	707118	5	125	17	104	5
12 01 00 02	707120	6	160	17	127	5
12 01 00 03	707111	10	240	17	188	5
12 01 00 04	707113	18	455	17	345	5

### 427QR QuickRelease extensions



Patent, DIN 3123/ISO 3316.



SW Code	Item Code	Size	L mm	d mm	△△ g	
12 01 10 01	707116 <sup>^</sup>	3	76	17	66	1
12 01 10 02	707122 <sup>^</sup>	6	160	17	127	1
12 01 10 03	707112 <sup>^</sup>	10	240	17	185	1

# 3/8" Drive Sockets and Tools

## Extensions with wobble-drive

swivel angle 15°  
each side,  
max. torque 80 N m.

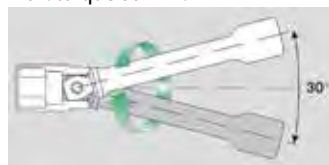

SW Code	Item Code	No.	L mm	d mm	△△ g	
12 01 00 07	707117	427/3W	76	17	67	5
12 01 00 08	707119	427/5W	125	17	104	5
12 01 00 09	707123	427/6W	160	17	127	5

## 1225 Special extension

curved, for use on magnetic switch  
diesel pump.



SW Code	Item Code	L mm	d mm	△△ g	
12 25 00 01	705742	150	17	128	5

## 428 Universal joint

DIN 3123/ISO 3316.



SW Code	Item Code	L mm	d mm	△△ g	
12 02 00 00	707124	46	18.8	55	5

## 431 Adaptor



3/8" socket x 1/4" plug  
(10 x 6.3mm),  
maximum torque 62 N m,  
DIN 3123/ISO 3316,  
HPQ® high performance steel



SW Code	Item Code	L mm	d mm	△△ g	
12 03 00 01	707127	28	17.2	26	5

## 432 Adaptor



3/8" socket x 1/2" plug  
(10 x 12.5mm),  
DIN 3123/ISO 3316,  
HPQ® high performance steel



SW Code	Item Code	L mm	d mm	△△ g	
12 03 00 03	707129	31	17.2	36	5

## SW45/45A/21/4TCS

## Socket set 3/8"

Metric and Imperial 3/8" Drive Socket Set with  
12 point sockets and quick release accessories.  
25 pieces In TCS foam, and plastic case



Content:

Metric: 8, 9, 10, 11, 12, 13, 14, 15,  
16, 17, 18, 19mm  
Imperial: 1/4, 5/16, 3/8, 7/16, 1/2, 9/16, 5/8,  
11/16, 3/4"

Plus:

1 ratchet 435qr  
2 extensions 427/3qr (76 mm),  
427/6qr (160 mm)  
1 universal joint 428qr



SW Code	Item Code
91 28 82 38	707383



# 1/2" Drive Sockets and Tools

## 50 Sockets



metric sizes: DIN 3124/ISO 2725-1, E DIN EN 3709, ASME B 107.5 M,  
American sizes: ASME B 107.1, Fed. Spec. GGG-W-641,  
SAE AS 954-E (test loads),  
HPQ® high performance steel, chrome plated.

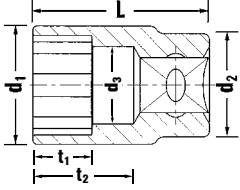

SW Code	Item Code	mm	d <sub>1</sub> mm	d <sub>2</sub> mm	d <sub>3</sub> mm	L mm	t <sub>1</sub> mm	t <sub>2</sub> mm	g	g	g
03 01 00 08	707839	8	13	22	7	38	9	22	56	10	10
03 01 00 09	707840	9	13.7	22	8	38	9	22	57	10	10
03 01 00 10	707814	10	14.5	22	9	38	9	22	57	10	10
03 01 00 11	707815	11	15.8	22	10	38	9.5	22	52	10	10
03 01 00 12	707816	12	17	22	11	38	13	22	58	10	10
03 01 00 13	707817	13	18.3	22	12	38	13	22	60	10	10
03 01 00 14	707818	14	19.9	22.7	13	38	13	20.5	60	10	10
03 01 00 15	707819	15	21.2	22.7	14	38	13.5	20.2	62	10	10
03 01 00 16	707820	16	22.4	23.7	15	38	13.5	19.6	63	10	10
03 01 00 17	707821 <sup>^</sup>	17	24	23.7	15.2	38	15	19.6	66	10	10
03 01 00 18	707822	18	24.7	23.7	17	38	15.5	19.1	71	10	10
03 01 00 19	707823	19	26.2	25	18	38	16	21.7	78	10	10
03 01 00 20	707824	20	27.2	25	19	42	17	25.5	89	10	10
03 01 00 21	707825	21	28.7	26	20	42	18	25.2	104	10	10
03 01 00 22	707826	22	29.7	26	21	42	18	24.9	113	10	10
03 01 00 23	707827	23	30.7	26	20	42	18	25.4	114	5	5
03 01 00 24	707828	24	32	26	21	42	18.5	24.9	117	5	5
03 01 00 25	707829	25	33.2	25	22	42	18.5	24.6	119	5	5
03 01 00 26	707830	26	34.4	25	23	42	18.5	24.3	122	5	5
03 01 00 27	707831	27	36.2	26	24	45	19.5	27	150	5	5
03 01 00 28	707832	28	37.4	27	25	45	19.5	26.7	158	5	5
03 01 00 30	707834	30	39.7	28	27	45	20.5	26.1	171	5	5
03 01 00 31	707835	31	42.2	28	28	47	22	27.9	215	5	5
03 01 00 32	707837	32	42.2	28	29	47	22	27.6	189	5	5
03 01 00 34	707838	34	45	28	31	47	22	27	209	5	5

## 50a Sockets

SW Code	Item Code	mm	d <sub>1</sub> mm	d <sub>2</sub> mm	d <sub>3</sub> mm	L mm	t <sub>1</sub> mm	t <sub>2</sub> mm	g	g	g
03 41 00 24	707857	3/8	14.3	22	8.3	38	9	22	57	10	10
03 41 00 28	707859	7/16	16.3	22	9.9	38	9	22	59	10	10
03 41 00 32	707850	1/2	18.3	22	11.5	38	13	22	59	10	10
03 41 00 34	707861	9/16	20.3	22.7	13.1	38	13	20.2	62	10	10
03 41 00 35	707854	19/32	21.3	22.7	13.5	38	13.5	20.1	61	10	10
03 41 00 36	707858	5/8	22.4	23.7	15	38	13.5	19.6	62	10	10
03 41 00 38	707851	11/16	24.2	23.7	16.5	38	15.5	19.2	68	10	10
03 41 00 40	707856	3/4	26.2	25	18	38	16	21.7	78	10	10
03 41 00 41	707855 <sup>^</sup>	25/32	27	25	18.6	41	16	24.6	90	5	5
03 41 00 42	707852	13/16	28.2	25	19.4	41	16.5	24.3	95	5	5
03 41 00 44	707860	7/8	29.7	26	21	42	18	24.9	111	5	5
03 41 00 46	707853	15/16	32	26	22.6	42	18.5	24.4	121	5	5
03 41 00 48	707841	1	33.7	27	24.2	42	18.5	24	135	5	5
03 41 00 50	707842	1 1/16	36.2	26	25.8	45	19.5	26.5	155	5	5
03 41 00 52	707845	1 1/8	38.1	28	27.4	45	20	26	167	5	5
03 41 00 54	707846	1 3/16	39	28	28	45	20.5	25.9	178	5	5
03 41 00 56	707844	1 1/4	40	28	30.5	45	21	25.1	196	5	5
03 41 00 58	707848	1 5/16	41.8	28	32.1	47	22	26.7	210	5	5
03 41 00 60	707847 <sup>^</sup>	1 3/8	46	28	33.7	50	23	29.2	232	5	5
03 41 00 62	707849 <sup>^</sup>	1 7/16	49.4	31	34	54	26	33.1	320	5	5
03 41 00 64	707843 <sup>^</sup>	1 1/2	51	31	35	54	26	32.8	330	5	5

6 Point sockets are also available - please contact customer service.

## 51 Sockets



extra deep, metric sizes: DIN 3124/ISO 2725-1, E DIN EN 3710,  
E DIN EN 3709, ASME B 107.5M,  
American sizes: ASME B 107.1, Fed. Spec. GGG-W-641, SAE AS 954-E,  
HPQ® high performance steel, chrome plated.

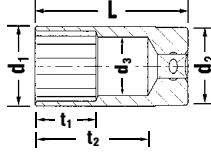

SW Code	Item Code	mm/"	d <sub>1</sub> mm	d <sub>2</sub> mm	d <sub>3</sub> mm	L mm	t <sub>1</sub> mm	t <sub>2</sub> mm	g	g	g
03 02 00 10	707939 <sup>^</sup>	10	14.5	22	9	83	19	67	90	10	10
03 02 00 13	707940 <sup>^</sup>	13	18.3	22	12	83	35	67	122	10	10
03 02 00 14	707941	14	19.9	22.7	13	83	35	65.2	129	10	10
03 02 00 15	707942	15	21.2	22.7	14	83	35	64.9	132	10	10
03 02 00 16	707943	16	22.4	23.7	15	83	35	64.6	145	10	10
03 02 02 16	707944 <sup>^</sup>	16-3/8 <sup>1)</sup>	22.4	23.7	15.4	83	19	64.5	137	10	10
03 02 00 17	707945 <sup>^</sup>	17	24	23.7	16	83	35	64.3	132	10	10
03 02 00 18	707946	18	24.7	23.7	17	83	35	64.1	170	10	10
03 02 00 19	707947 <sup>^</sup>	19	26.2	25	18	83	35	66.7	186	10	10
03 02 02 08	707949 <sup>^</sup>	20.8-19/16 <sup>1)</sup>	27.7	26	20	83	22	66.2	194	10	10
03 02 00 21	707950	21	28.7	26.5	20	83	35	66.2	231	10	10
03 02 00 22	707951	22	29.7	27.5	21	83	35	65.5	200	10	10
03 02 00 24	707952 <sup>^</sup>	24	32	30	21	83	35	66.1	280	5	5
03 02 00 26	707953	26	34.4	32.5	23	83	35	65.3	334	5	5
03 02 00 27	707954	27 <sup>2)</sup>	36.2	34	27	83	20	60	294	5	5
03 02 00 30	707955	30 <sup>2)</sup>	39.7	37.5	30.2	83	35	65	381	5	5
03 02 00 32	707956	32	42.4	40	29	83	35	63.9	461	5	5

<sup>1)</sup> with rubber insert for spark plugs

<sup>2)</sup> for diesel injector (VW, Audi, Mercedes, Opel, Ford, Peugeot, Volvo, Toyota, Mazda, Nissan, Mitsubishi, Daihatsu)

## 51a Sockets

SW Code	Item Code	mm	d <sub>1</sub> mm	d <sub>2</sub> mm	d <sub>3</sub> mm	L mm	t <sub>1</sub> mm	t <sub>2</sub> mm	g	g	g
03 42 00 24	707971 <sup>^</sup>	3/8	14.3	22	8.3	83	19	67	93	5	5
03 42 00 28	707973 <sup>^</sup>	7/16	16.3	22	9.9	83	19	67	102	5	5
03 42 00 32	707966 <sup>^</sup>	1/2	18.3	22	11.5	83	35	67	122	5	5
03 42 00 34	707975 <sup>^</sup>	9/16	20.3	22.7	13.1	83	35	65.2	131	5	5
03 42 00 36	707972 <sup>^</sup>	5/8	22.4	23.7	15	83	35	64.6	145	5	5
03 42 00 38	707967 <sup>^</sup>	11/16	24.2	23.7	16.5	83	35	64.2	158	5	5
03 42 00 40	707970 <sup>^</sup>	3/4	26.2	25	18	83	35	66.7	188	5	5
03 42 00 42	707968 <sup>^</sup>	13/16	27.7	26	19.5	83	35	66.3	170	5	5
03 42 00 44	707974 <sup>^</sup>	7/8	29.7	27.5	21	83	35	65.9	200	5	5
03 42 00 46	707969 <sup>^</sup>	15/16	32	30	22.6	83	35	65.7	281	5	5
03 42 00 48	707957 <sup>^</sup>	1	33.7	32	24.2	83	35	65	260	5	5
03 42 00 50	707958 <sup>^</sup>	1 1/16	36.2	34	25.8	83	35	64.5	359	5	5
03 42 00 52	707961 <sup>^</sup>	1 1/8	38.1	36	27.4	83	35	64	300	5	5
03 42 00 54	707962 <sup>^</sup>	1 3/16	39	37	28	83	35	63.9	377	5	5
03 42 00 56	707960 <sup>^</sup>	1 1/4	40	38	30.5	83	35	63.1	433	5	5
03 42 00 58	707964 <sup>^</sup>	1 5/16	41.8	40	32.1	83	35	62.7	479	5	5
03 42 00 60	707963 <sup>^</sup>	1 3/8	46	44	33.7	83	35	62.2	506	5	5
03 42 00 62	707965 <sup>^</sup>	1 7/16	49.4	47	34	83	35	62.1	635	5	5
03 42 00 64	707959 <sup>^</sup>	1 1/2	51	49	35	83	35	61.8	675	5	5



# 1/2" Drive Sockets and Tools

## 54 INHEX sockets

for hexagon socket head screws, DIN 7422,  
Chrome Alloy Steel, chrome plated.

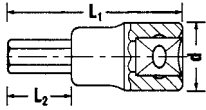

SW Code	Item Code	mm	L <sub>1</sub> mm	L <sub>2</sub> mm	d mm	g	
03 05 00 04	708099	4	60	22	22.7	68	5
03 05 00 05	708100	5	60	22	22.7	68	5
03 05 00 06	708101	6	60	22	22.7	71	5
03 05 00 07	708102	7	60	22	22.7	75	5
03 05 00 08	708103	8	60	22	22.7	79	5
03 05 00 10	708094 <sup>^</sup>	10	60	22	22.7	97	5
03 05 00 12	708095	12	60	20	23.7	122	5
03 05 00 14	708096	14	60	20	23.7	135	5
03 05 00 17	708097	17	60	20	27.5	186	5
03 05 00 19	708098	19	60	20	31	242	5

## 54a INHEX sockets

SW Code	Item Code	"	L <sub>1</sub> mm	L <sub>2</sub> mm	d mm	g	
03 45 00 14	708111	7/32	60	22	22.7	70	5
03 45 00 16	708105	1/4	60	22	22.7	75	5
03 45 00 20	708108	5/16	60	22	22.7	81	5
03 45 00 24	708107	3/8	60	22	22.7	97	5
03 45 00 28	708110	7/16	60	22	22.7	103	5
03 45 00 32	708104	1/2	60	20	23.7	125	5
03 45 00 34	708112	9/16	60	20	23.7	137	5
03 45 00 36	708109	5/8	60	20	27.5	169	5
03 45 00 40	708106 <sup>^</sup>	3/4	60	20	31	244	2

## 54/10 INHEX socket set No-54

sizes 4; 5; 6; 7; 8; 10; 12; 14; 17; 19-mm



SW Code	Item Code	g
96 03 05 08	708166 <sup>^</sup>	1655

in sturdy sheet steel case

## INHEX sockets

for hexagon socket head screws,  
extra long, DIN 7422,  
Chrome Alloy Steel, chrome plated.

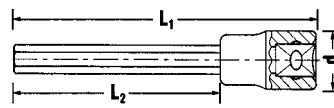

SW Code	Item Code	No.	mm	L <sub>1</sub> mm	L <sub>2</sub> mm	d mm	g	
03 15 12 05	706398	2054/5	5	120	82	22.7	78	5
03 15 12 06	706399	2054/6	6	120	82	22.7	84	5
03 15 12 07	706400	2054/7	7	120	82	22.7	96	5
03 15 12 08	705160	1054/8K	8	120	82	22.7	104	5
03 15 14 10	705152	1054/10	10	140	102	22.7	150	5
03 15 14 12	705153	1054/12 <sup>1)</sup>	12	140	100	23.7	197	5
03 15 14 14	706397	2054/14	14	140	100	23.7	231	5

<sup>1)</sup> For fitting radiators

## INHEX sockets

for hexagon socket head screws,  
special lengths, DIN 7422,  
Chrome Alloy Steel, chrome plated.



SW Code	Item Code	No.	mm	L <sub>1</sub> mm	L <sub>2</sub> mm	d mm	g	
03 15 18 05	705155	1054/5	5	180	20	22	118	5
03 15 07 06	705156	1054/6	6	70	32	22.7	72	5
03 15 10 06	706682 <sup>^</sup>	3054/6 <sup>1)</sup>	6	100	62	22.7	80	5
03 15 22 06	705157 <sup>^</sup>	1054/6L	6	220	182	22.7	108	5
03 15 10 07	705158	1054/7	7	100	62	22.7	87	5
03 15 08 08	706683 <sup>^</sup>	3054/8	8	80	42	22.7	88	5
03 15 14 08	705159	1054/8	8	140	102	22.7	114	5
03 15 07 13	705154	1054/13	13	70	25	24	130	5

<sup>1)</sup> for intake manifolds on 5-cylinder diesel engines on VW/Audi and T4 vans

## 54KK INHEX sockets

with ball point hexagon,  
for hexagon socket head screws,  
swivel angle up to 25° each side,  
Chrome Alloy Steel, chrome plated.

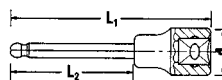

SW Code	Item Code	mm	L <sub>1</sub> mm	L <sub>2</sub> mm	d mm	g	
03 28 00 05	708131	5	100	62	22.7	75	5
03 28 00 06	708132	6	100	62	22.7	80	5
03 28 00 07	708133 <sup>^</sup>	7 <sup>1)</sup>	100	62	22.7	84	5
03 28 00 08	708134	8	100	62	22.7	95	5
03 28 00 10	708130	10	100	62	22.7	120	5

<sup>1)</sup> Application: BMW brakes

# 1/2" Drive Sockets and Tools

## 1054KK ● INHEX sockets

with ball point hexagon,  
for hexagon socket head screws,  
swivel angle up to 25° each side,  
special lengths,  
Chrome Alloy Steel, chrome plated.



SW Code	Item Code	mm	L <sub>1</sub> mm	L <sub>2</sub> mm	d mm	g	
03 31 00 05	705142	5	238	200	22.7	145	5
03 31 00 08	705143	8	238	200	22.7	154	5

## 54CV ● Screwdriver sockets

for spline socket head screws  
(Ribe CV®), Chrome Alloy Steel, chrome plated.

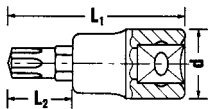

SW Code	Item Code	Size	L <sub>1</sub> mm	L <sub>2</sub> mm	d mm	g	
03 09 00 05	708123	M5	60	22	22.7	69	5
03 09 00 06	708118	M6	60	22	22.7	71	5
03 09 00 07	708119	M7	60	22	22.7	78	5
03 09 00 08	708120	M8	60	22	22.7	78	5
03 09 00 09	708121	M9	60	22	22.7	92	5
03 09 00 10	708113	M10	60	22	22.7	95	5
03 09 00 12	708114	M12	60	20	23.7	119	5
03 09 00 13	708115	M13	60	20	23.7	123	5
03 09 00 14	708116	M14	60	20	23.7	126	5
03 09 00 16	708117 <sup>^</sup>	M16	63	23	27.5	163	5

Application:

Size M7, for brakes, cylinder head screws, bodywork and motor jobs incl. valve covers and spark plug covers on Fiat vehicles  
Size M8, bodywork and motor jobs incl. valve covers and spark plug covers on Fiat vehicles  
Size M9, brakes, cylinder head screws (1.2 l; 8V/16V) on Fiat vehicles  
Size M10, for cylinder head screws (1.2 l; 8V/16V) on Fiat vehicles  
Size M12 for cylinder head screws on Fiat 2.0 l engines  
Size M13, for brakes, cylinder head screws on Fiat vehicles; cylinder head screws on Alfa vehicles, e.g. 1.6 l; 16V engines  
Size M14; M16, for cylinder head screws on Alfa vehicles, e.g. 1.6 l; 16V engines

## 54X ● Screwdriver sockets

for trisquare socket head screws (XZN<sup>®</sup>), DIN 2324,  
Chrome Alloy Steel, chrome plated.

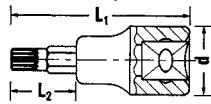

SW Code	Item Code	Size	L <sub>1</sub> mm	L <sub>2</sub> mm	d mm	g	
03 06 00 05	708163	M5	60	22	22.7	67	5
03 06 00 06	708164	M6	60	22	22.7	74	5
03 06 00 08	708165	M8	60	22	22.7	79	5
03 06 00 10	708159	M10	60	22	22.7	94	5
03 06 00 12	708160	M12	60	20	23.7	120	5
03 06 00 14	708161	M14	60	20	23.7	128	5
03 06 00 16	708162	M16	60	20	27.5	174	5

## 3054X ● Screwdriver sockets

for trisquare socket head screws (XZN<sup>®</sup>), DIN 2324,  
extra long,  
Chrome Alloy Steel, chrome plated.

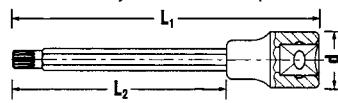

SW Code	Item Code	Size	L <sub>1</sub> mm	L <sub>2</sub> mm	d mm	g	
03 26 14 08	706681	M8	140	102	22.7	109	5
03 26 14 10	706678	M10	140	102	22.7	142	5
03 26 14 12	706679	M12	140	102	22.7	160	5
03 26 14 14	706680	M14	140	100	23.7	225	1

Application: sizes M10 and M12 for cylinder head screws on VW/Audi, Opel, mercedes-Benz.  
size M14 for cylinder head screws on VM diesel engines, Chrysler

## ● Screwdriver sockets

for trisquare socket head screws (XZN<sup>®</sup>), special lengths,  
DIN 2324,  
Chrome Alloy Steel, chrome plated.



SW Code	Item Code	No.	Size	L <sub>1</sub> mm	L <sub>2</sub> mm	d mm	g	
03 16 08 08	705151 <sup>^</sup>	1054x	M8	80	42	22.7	86	5
03 16 12 08	706405	2054x	M8	120	82	22.7	104	5
03 16 11 10	706403	2054x	M10	110	72	22.7	130	5
03 16 11 12	706404	2054x	M12	110	70	23.7	168	5

Application: No-1054x, size M8, for jointed shafts on VW/Audi

## 54TX ● Screwdriver sockets

for inside TORX<sup>®</sup> screws,  
Chrome Alloy Steel, chrome plated.

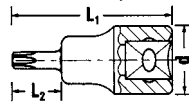

SW Code	Item Code	Size	mm	L <sub>1</sub> mm	L <sub>2</sub> mm	d mm	g	
03 10 00 20	708149	T20	3.8	55	17	22.7	71	5
03 10 00 25	708150	T25	4.4	55	17	22.7	71	5
03 10 00 27	708151	T27	5	55	17	22.7	72	5
03 10 00 30	708152 <sup>^</sup>	T30	5.5	55	17	22.7	72	5
03 10 00 40	708153	T40	6.6	55	17	22.7	72	5
03 10 00 45	708154	T45	7.8	55	17	22.7	74	5
03 10 00 50	708155	T50	8.8	55	17	22.7	86	5
03 10 00 55	708156	T55	11.2	58	18	23.7	112	5
03 10 00 60	708157	T60	13.2	58	18	23.7	113	5

Application: size T55 for the cylinder head screws on the Opel Omega V6

## 54TX/9 ● Set: Screwdriver sockets

for inside TORX<sup>®</sup> screws, 9 pieces,  
Content: sizes T20; T25; T27; T30; T40; T45; T50; T55; T60



SW Code	Item Code	g	
96 03 10 04	708137	820	1

packed in carton

# 1/2" Drive Sockets and Tools

## Screwdriver sockets

for inside TORX® screws,  
extra long,  
Chrome Alloy Steel, chrome plated.

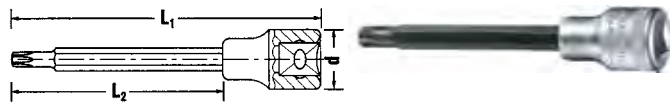

SW Code	Item Code	No.	Size	mm	L <sub>1</sub> mm	L <sub>2</sub> mm	d mm	$\Delta$ g	
03 13 12 30	705144	1054TX	T30	5.5	120	82	22.7	99	5
03 13 14 40	706401	2054TX	T40	6.6	140	102	22.7	110	5
03 13 14 45	706402	2054TX	T45	7.8	140	102	22.7	111	5
03 13 14 50	705147	1054TX	T50	8.8	140	102	22.7	143	5
03 13 14 55	705148	1054TX	T55	11.2	140	102	22.7	159	5
03 13 14 60	705149	1054TX	T60	13.2	140	100	23.7	221	5

Application: size T45 for the intake rail of the Ford Scorpio with a 2.4; 2.8; 2.9 l injection engine and for the VW Passat from April 1989 with a 1.6; 1.8; 2.0 l engine and gearbox type 02A, size T55 for the cylinder head screws on various Ford models, e.g. Mondeo 16V

## 1054TX Screwdriver sockets

for inside TORX® screws,  
extra long,  
Chrome Alloy Steel, chrome plated.

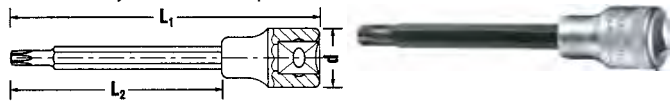

SW Code	Item Code	Size	mm	L <sub>1</sub> mm	L <sub>2</sub> mm	d mm	$\Delta$ g	
03 13 12 40	705145 <sup>^</sup>	T40	6.6	120	82	22.7	100	5
03 13 12 45	705146 <sup>^</sup>	T45	7.8	120	82	22.7	100	5
03 13 10 70	705150	T70 <sup>1)</sup>	15.5	107	67	23.7	201	5

1) for cylinder head screws type Ford 1.8 l diesel (Turbo) Fiesta, Escort, Sierra, P100 from 8/92

## Drive tools and accessories

1/2", finish: Chrome Alloy Steel, chrome plated.

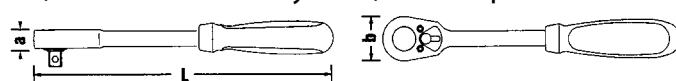

## 512 Ratchet

reversible (36 teeth),  
with 2-component handle  
DIN 3122/ISO 3315.



SW Code	Item Code	L mm	b mm	a mm	$\Delta$ g	
13 11 10 10	707998	265.5	41	18	600	1

## 512QR QuickRelease ratchet



reversible (36 teeth),  
with QuickRelease safety  
locks and 2-component  
handles, DIN 3122/ISO 3315.



SW Code	Item Code	L mm	b mm	a mm	$\Delta$ g	
13 11 00 20	708012	265.5	41	21	599	1

## 512SG-QR Ratchet



reversible (36 teeth), with  
QuickRelease safety  
lock and steel handle,  
DIN 3122/ISO 3315.



SW Code	Item Code	L mm	b mm	a mm	$\Delta$ g	
13 11 00 30	708014	265.5	41	18	680	1

## 517 Flexible joint ratchet

reversible (60 teeth),  
handle may be raised or lowered by  
approx. 90°. Lockable in following  
positions: straight, 30° up,  
60° up, 30° down.



Unlocked by depressing button  
in handle, registered design.

SW Code	Item Code	L mm	b mm	a mm	$\Delta$ g	
13 26 00 01	708029	415	43	26	798	1

## Spare parts for ratchets No-512, 512SG, 532, 538

### 5120 + 7210/15 Spare parts set

Content:  
1 Pinion  
1 Pawl  
1 Lever with pin  
1 Ball  
2 Compression Springs  
2 Screws

SW Code	Item Code	$\Delta$ g	
19 04 00 00	708006	127	1

for ratchets from 1990



# 1/2" Drive Sockets and Tools

## Spare parts for ratchets No-512, 512SG-QR

### 5120 QR Spare parts set



Content:  
1 Pinion  
1 Pawl  
1 Lever with pin  
1 Ball  
2 Compression Springs  
2 Screws

SW Code	Item Code	g	Box
19 04 00 20	708003	127	1

## Spare parts for ratchets No-515, 517

### 7350/20 Spare parts sets

Content:  
1 Pinion  
1 Pawl  
1 Switching disk  
1 Spring  
3 Screws

SW Code	Item Code	g	Box
59 25 10 20	709090	146	1

for ratchets from 4/96

### 504 Flexible handle

DIN 3122/ISO 3315.  
with 2-component handle.



SW Code	Item Code	Size	L mm	g	Box
13 06 10 12	707907	15	397	674	1
13 06 10 13	707908	18	469	770	1

### 504 Spare parts set

for No-504.  
Content:  
1 Universal Joint  
1 Screw  
1 Spring Washer



SW Code	Item Code	g	Box
96 19 08 00	707909	75	1

### 506 Sliding T-handle

DIN 3122/ISO 3315.



SW Code	Item Code	L mm	g	Box
13 07 00 00	707910 <sup>^</sup>	300	436	5

### 506QR QuickRelease sliding T-handle



Patent, with QuickRelease safety lock.

SW Code	Item Code	L mm	g	Box
13 07 10 00	707911 <sup>^</sup>	300	470	1

### 509 Extensions

DIN 3123/ISO 3316.

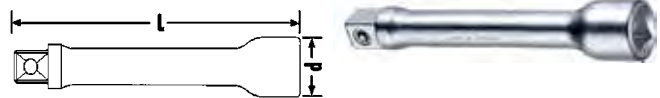

SW Code	Item Code	Size	L mm	d mm	g	Box
13 01 00 01	707916	2	52	23	88	5
13 01 00 04	707920	3	75	23.2	120	5
13 01 00 02	707923	5	130	23.2	191	5
13 01 00 03	707912	10	255	23.2	341	5

### Extensions with wobble-drive

swivel angle 15°  
each side,  
maximum torque 200 N m.

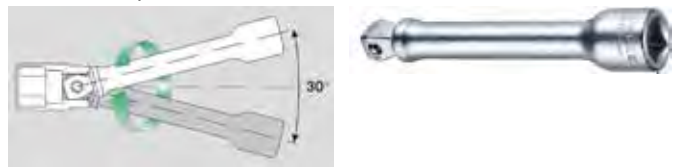

SW Code	Item Code	No.	L mm	d mm	g	Box
13 01 00 05	707919	509/2W	52	23	88	5
13 01 00 06	707922	509/3W	75	23.2	120	5
13 01 00 07	707926	509/5W	130	23.2	191	5
13 01 00 08	707915	509/10W	255	23.2	341	5

### QuickRelease extensions



Patent  
DIN 3123/ISO 3316.



SW Code	Item Code	No.	L mm	d mm	g	Box
13 01 10 01	707918 <sup>^</sup>	509/2QR	52	23	90	1
13 01 10 04	707921 <sup>^</sup>	509/3QR	75	23	123	1
13 01 10 02	707925 <sup>^</sup>	509/5QR	130	23	187	1
13 01 10 03	707914 <sup>^</sup>	509/10QR	255	23	341	1

### 3505 Special extension

for CROW-FOOT spanner No-3540



SW Code	Item Code	L mm	d mm	g	Box
13 21 00 01	706704	120	23.2	186	1



# 1/2" Drive Sockets and Tools

## 510 Universal joint

DIN 3123/ISO 3316.



SW Code	Item Code	L mm	d mm	g	
13 02 00 00	707993 <sup>^</sup>	71	25	146	5

## 510QR QuickRelease universal joint



Patent, DIN 3123/ISO 3316, with QuickRelease safety lock.

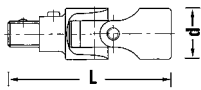

SW Code	Item Code	L mm	d mm	g	
13 02 10 00	707997 <sup>^</sup>	80	25	157	1

## 513 Adaptor



1/2" socket x 3/8" plug  
(12.5 x 10mm),  
maximum torque 202 N m,  
DIN 3123/ISO 3316,  
HPQ<sup>®</sup> high performance steel.



SW Code	Item Code	L mm	d mm	g	
13 03 00 02	708015	35	22.7	55	5

## 514 Adaptor



1/2" socket x 3/4" plug  
(12.5 x 20mm),  
DIN 3123/ISO 3316,  
HPQ<sup>®</sup> high performance steel.



SW Code	Item Code	L mm	d mm	g	
13 03 00 05	708017	44	25	118	5

## 50a/17/6 Socket set 1/2"

in sturdy sheet steel case,  
23 pieces

Content:

17 sockets with bi-hexagon No 50a:  
sizes 3/8; 7/16; 1/2; 9/16; 19/32; 5/8; 11/16; 3/4;  
25/32; 13/16; 7/8; 15/16; 1; 1 1/16; 1 1/8; 1 3/16;  
1 1/4"

1 ratchet No 512

3 extensions No 509/2 (52 mm), No  
509/5 (130 mm),

No 509/10 (255 mm)

1 T-handle No 506

1 universal joint No 510



SW Code	Item Code	g
96 03 41 25	707932 <sup>^</sup>	5145

## SW50/50A/29/5TCS Socket set 1/2"



Metric and Imperial 1/2" Drive  
Socket Set with 12 point sockets  
and quick release accessories.

34 pieces in TCS foam, and  
plastic case

Content:

Metric: 10, 11, 12, 13, 14, 15, 16, 17,

18, 19, 21, 22, 24, 27, 30, 32mm

Imperial: 3/8; 7/16; 1/2; 9/16; 5/8; 11/16; 3/4; 13/16; 7/8; 15/16; 1; 1 1/16; 1 1/8"

Plus:

1 ratchet 512qr

3 extensions 509/3qr (75 mm), 509/5qr (130 mm), 509/10qr (255 mm)

1 universal joint 510qr



SW Code	Item Code
91 33 82 12	707901



# 3/4" Drive Sockets and Tools

## 568 Adaptor

**HPQ**  
 3/4" socket x 1/2" plug (20 x 12.5mm),  
 maximum torque 512 N m,  
 DIN 3123/ISO 3316,  
 HPQ® high performance steel.



SW Code	Item Code	L mm	d mm	△△ g	☐
15 03 00 03	708356	55	34.7	203	5

## 569 Adaptor

**HPQ**  
 3/4" inside x 1" plug (20 x 25mm),  
 DIN 3123/ISO 3316,  
 HPQ® high performance steel.



SW Code	Item Code	L mm	d mm	△△ g	☐
15 03 00 06	708358 <sup>^</sup>	61	34.7	295	5

## 55/10/6 Socket set 3/4" ☐

in sturdy sheet steel case,  
 16 pieces  
 Content:  
 10 sockets with hexagon No 55:  
 sizes 22; 24; 27; 30; 32; 34; 36;  
 41; 46; 50 mm  
 1 ratchet No 552  
 2 extensions No 559/8 (200 mm),  
 No 559/16 (400 mm)  
 1 flexible head No 554  
 1 sliding head for T-handle No 556  
 1 bar handle No 558



SW Code	Item Code	△△ g
96 05 01 04	708291 <sup>^</sup>	13965

# 1" Drive Sockets and Tools

## Drive tools and accessories

1" ☐, finish: Chrome Alloy Steel, chrome plated.

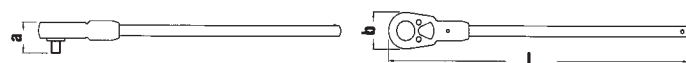

## 882 Ratchet

reversible (36 teeth),  
 without Bar Handle No-888.



SW Code	Item Code	L mm	b mm	a mm	△△ g	☐
16 11 00 00	709370 <sup>^</sup>	185	70	60	2000	1

## 886 Sliding head

without bar handle No 888.



SW Code	Item Code	L mm	d mm	△△ g	☐
16 07 00 00	709376	80	48	605	1

## 884 Flexible head



SW Code	Item Code	L mm	d mm	△△ g	☐
16 06 00 00	709374 <sup>^</sup>	195	48	1800	1

## 888 Bar handle



SW Code	Item Code	L mm	d mm	△△ g	☐
16 17 00 00	709378 <sup>^</sup>	700	28	3320	1

# MANOSKOP® 714

## Electromechanical torque and angle-controlled wrench

Benefits at a glance:

- Indicating and with cut-out
- 4 measuring methods (torque, angle, torque backed up by angle, angle backed up by torque)
- Freely configurable menu structure
- Includes Sensomaster software for easy configuration of the tool
- 3 function modes: cut-out, peak (indicating mode displaying peak reading) and track (indicating mode displaying current value)
- Angle-controlled measurement without a reference arm
- Data storage (≤ 2,500 tightening jobs)
- Acoustic and visual assessment of the joint
- Clockwise and anticlockwise tightening
- Tactile and acoustic trigger signals
- Torque and angle are simultaneously visible
- All readings are independent of the point of application of force with sizes 1, 2 and 4
- Display deviation value ± 2 % for torque and ± 1% for angle



- |  |  |
|--|--|
| <p><b>1</b> High-definition graphical colour display with additional side-mounted indicator lamps</p> <p><b>2</b> Automatic key-lock prevents inadvertent changes</p> <p><b>3</b> Fast, accurate setting via keypad</p> <p><b>4</b> Own ident number can be stored in the wrench</p> <p><b>5</b> Indicator lamps clearly visible from all sides<br/>Yellow light: advance warning threshold reached<br/>Green light: within the target range<br/>Red light: reading is outside the tolerance range</p> <p><b>6</b> In a sturdy plastic case with foam inlays (sizes 40–100 in steel case)<br/>With certificate</p> | <p><b>7</b> Optional extras: Li-Ion battery No 7195-2 and charger No 7160</p> <p><b>8</b> Individually configurable menus</p> <p><b>9</b> Micro USB interface</p> <p><b>10</b> Battery compartment with smooth-action bayonet fitting</p> <p><b>11</b> Up to 200 joints can be programmed in up to 25 sequences</p> <p><b>12</b> The wrench reminds the user automatically when calibration is due – either by the number of joints or the time interval</p> |
|--|--|



## MANOSKOP® 714 – indicating and cut-out Electromechanical torque and angle-controlled wrench

- 4 measuring modes (torque, angle, torque backed up by angle, angle backed up by torque)
- high-definition colour display with additional side-mounted indicator lamps
- freely configurable menu structure
- Optionally: Li-ion battery No 7195-2 and charger No 7160
- 3 function modes: cut-out, peak (indicating mode with peak value) and track (indicating mode with current value)
- Micro USB 2.0 interface
- bayonet connection for battery compartment
- QuickRelease safety lock change system for insert tools
- angle-controlled measurement without a reference arm
- data storage (< 2500 tightening jobs)
- as many as 200 joints can be programmed in up to 25 preset sequences.
- different tolerance limits can be set for each joint
- acoustic and visual assessment of the joint
- rapid, accurate setting via keypad
- the automatic keypad lock prevents inadvertent changes
- overload protection by means of acoustic and visual signals and a fail-safe system (clockwise)
- automatic notification of the next calibration date, either by the number of joints or the time interval
- fully automated calibrating and adjusting using the perfectControl calibrating and adjusting unit No 7794-2 (torque) or 7794-3 (torque and angle)
- units of measure: N m, ft.lb, in.lb.
- tightening torque is automatically corrected if a deviating extension is entered
- immediately reusable after release
- clockwise and anticlockwise tightening – it may be necessary to refit the insert tool rotated through 180° for anticlockwise tightening in the cut-out mode
- tactile, visual and acoustic trigger signal.
- torque and angle are simultaneously visible
- all readings are independent of the point of application of force (with sizes 1, 2 and 4)
- safe handling due to ergonomically designed handle (resistant to oils, grease, fuels, brake fluid and Skydrol)
- 2 certificates (torque, angle)
- in sturdy plastic case (size 40 in steel case)
- design patent, other patents applied for
- supplied with Sensomaster software, USB cable, 4 AAA/LR03 micro-batteries, 1.5 V. AAA, 1.2 V, micro NiMH rechargeable batteries can be used
- display resolution, angle 0.1°
- display deviation value, angle ±1%, ±1 digit
- display resolution, torque (< 40 N m: 0.01 N m; > 40 N m: 0.1 N m)
- display deviation value, angle ±2%, ±1 digit

### 714 Basic wrenches with tool carrier for insert tools

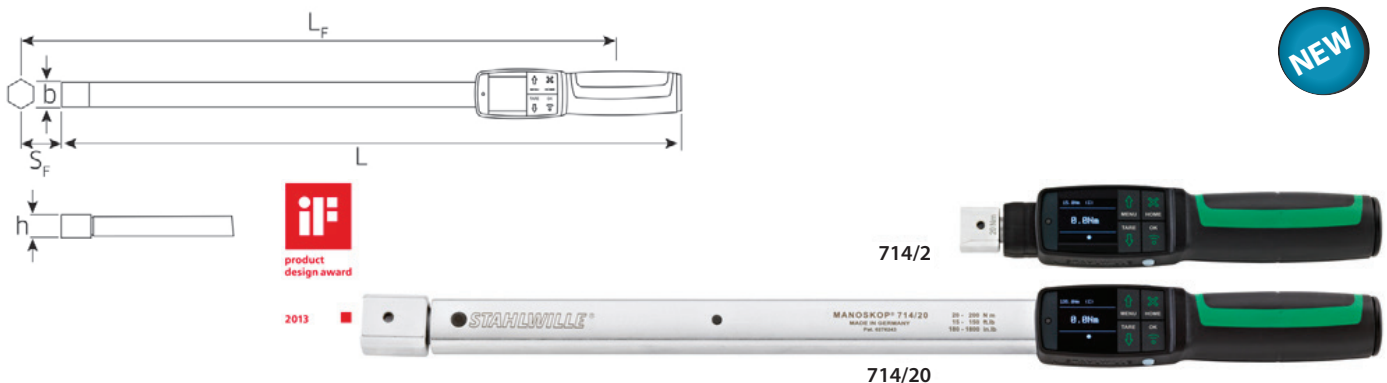

SW Code	Item Code	size	N m	ft.lb	in.lb	mm	b mm	h mm	L mm	L <sub>F</sub> mm	S <sub>F</sub> mm	g	g with box
96 50 09 01	800650 <sup>^</sup>	1	1 - 10	0.75 - 7.5	9 - 90	9x12	28	23	226	188	17.5	370	795
96 50 09 02	800651 <sup>^</sup>	2	2 - 20	1.5 - 15	18 - 180	9x12	28	23	226	188	17.5	380	805
96 50 09 04	800652 <sup>^</sup>	4	4 - 40	3 - 30	36 - 360	9x12	28	23	252	214	17.5	420	845
96 50 09 06	800653 <sup>^</sup>	6	6 - 60	4.5 - 45	54 - 540	9x12	28	23	393	355	17.5	810	1235
96 50 09 10	800654 <sup>^</sup>	10	10 - 100	7.5 - 75	90 - 900	9x12	28	23	466	428	17.5	1085	1510
96 50 09 20	800655 <sup>^</sup>	20	20 - 200	15 - 150	180 - 1800	14x18	28	23	547	516	25	1361	1896
96 50 09 40	800656 <sup>^</sup>	40	40 - 400	30 - 300	360 - 3600	14x18	28	23	687	656	25	1765	5155

Refer inserts on page 63-64

# MANOSKOP® 730D

## Electromechanical torque wrench

Benefits at a glance:

- Cut-out and indicating
- Displays the torque actually applied after the wrench cuts out. In this way, the user has the opportunity to optimise his or her working methods.
- Units of measurement: N m / ft.lb / in.lb
- Automatic keypad lock
- Display also works for anticlockwise torque
- Angle-controlled measurement without a reference arm using a supplementary module
- Overload protection by means of acoustic and visual signals
- Automatic compensation to achieve correct tightening torque even if a changed extension is entered
- Different tolerance limits can be set for each joint
- Visual red and green signals in the display confirm the status of the joint
- Additional security for presets using PIN code
- Automatic notification of the next calibration date
- Deviation of indication  $\pm 2\%$

Measure, cut-out and record: When the preset torque is reached, the torque wrench cuts out and indicates this fact to the user via a definite tactile and audible signal. The tightening torques are stored. The data can be transferred to a PC for evaluation and documentation.



7395-1

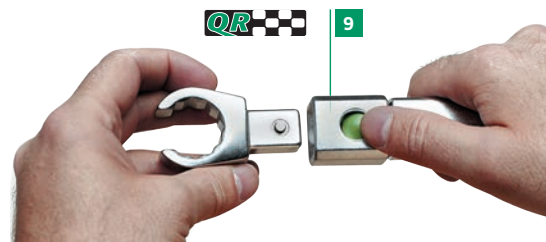

- |   |  |
|---|--|
| <p><b>1</b> The square drive enables a broad range of insert tools</p> <p><b>2</b> Dual stop signal with tactile and acoustic cut-out signals</p> <p><b>3</b> Easy-to-read display</p> <p><b>4</b> Rapid setting<br/>The convenient keypad enables the torque wrench to be quickly and easily set</p> | <p><b>5</b> Power supply two 1.5 V AA batteries</p> <p><b>6</b> Angle controlled tightening<br/>Simply attach the Angle Module No 7395-1 and connect the cable to the interface</p> <p><b>7</b> Data output USB interface</p> <p><b>8</b> 2-component handle has ergonomically designed, green softer layers and is resistant to oils, grease, fuels, brake fluids and Skydrol.</p> <p><b>9</b> QuickRelease safety lock</p> |
|---|--|

## Service work & series production MANOSKOP® 730D – indicating and cut-out

This electromechanical torque wrench combines the “indicating” and “cut-out” functions in a single tool; the function modes can be selected independently of each other.

With a mount for interchangeable sockets and inserts and QuickRelease safety lock;

rapid setting using the convenient foil keypad and large display; tactile and acoustic trigger signal.

Differing tolerance limits can be set for each joint. Visual red and green signals in the display confirm the status of the joint.

Display also works for anti-clockwise torque.

7500 data records can be stored, transferred via a USB interface and evaluated on the PC. Automatic compensation to achieve correct tightening torque even if a changed extension is entered.

Overload protection by means of acoustic and visual signs. The automatic keypad lock prevents inadvertent changes. Additional security for presets (function mode, trigger or preset value, unit of measurement, tolerance, save, deviating extension) using PIN code.

All the sensitive components are protected by the sturdy housing. The 2-component handle with its ergonomically designed green softer layers is resistant to oils, grease, fuels, brake fluid and Skydrol. Included in the set are 2 AA NiMH rechargeable batteries, 1.2 V, 2300 mAh. It is also possible to use 1.5 V AA batteries.

Automatic notification of the next calibration date. Simple calibration and, if required, adjustment without disassembly using Torque Tester No 7707 W.

Units of measurement: N m, ft.lb in.lb

Guaranteed maximum accuracy deviation  $\pm 2\%$ . With certificate.

(Inserts see page 62 of this catalogue)

### 730D Basic wrenches with tool carrier for insert tools

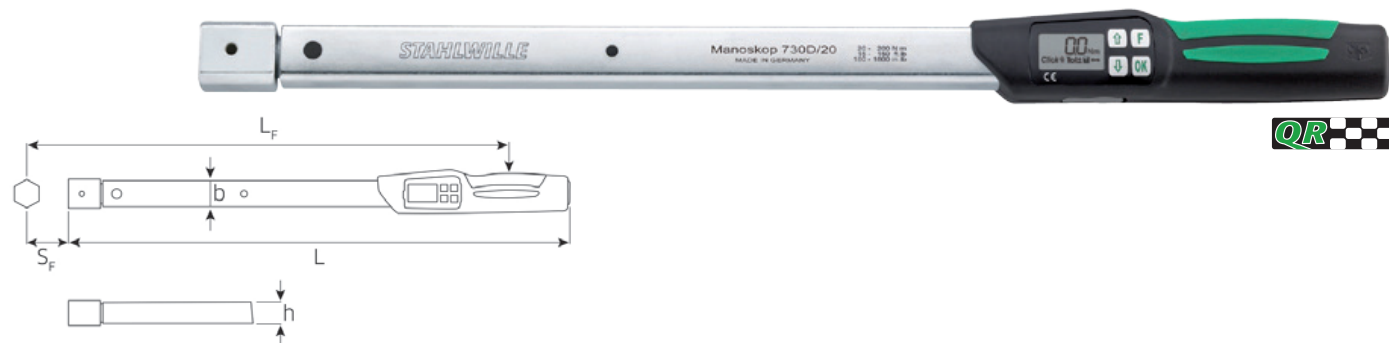

SW Code	Item Code	size	Setting/display resolution			mm	b	h	L	L <sub>F</sub>	S <sub>F</sub>	g	g			
			N m	ft.lb	in.lb									Nm	ft.lb	in.lb
96 50 17 10	708876	10	10 - 100	7.4 - 75	90 - 900	0.2/0.1	0.2/0.1	2/1.0	9x12	28	23	467	426.5	17.5	1085	1510
96 50 17 20	708877	20	20 - 200	15 - 150	180 - 1800	0.5/0.1	0.5/0.1	5/1.0	14x18	28	23	548	515	25	1361	1896
96 50 17 40	708878 <sup>^</sup>	40	40 - 400	30 - 300	360 - 3600	1.0/0.1	1.0/0.1	10/1.0	14x18	28	23	688	655	25	1765	5155
96 50 17 65	708879 <sup>^</sup>	65	65 - 650	48 - 480	580 - 5800	1.0/0.1	1.0/0.1	10/1.0	14x18	30.6	25.6	870	837	25	3300	6000

Refer inserts on page 63-64

# MANOSKOP® 730N

## Mechanical torque wrench

**Benefits at a glance:**

- Accurate one-handed setting – quick & easy control using the knob at the end of the handle
- Audible setting positions
- Fail-safe setting mechanism in the knob
- Clearly readable twin scale (N m and ft.lb)
- Noticeable double signals when the preset torque is reached
- Square drives with
- QuickRelease safety locks – for 9x12, 14x18 and 22x28 mm
- Handle is resistant to oils, grease, fuels, brake fluids and Skydrol
- Deviation of indication  $\pm 3\%$



**STAHLWILLE**

- |   |  |
|---|--|
| <p><b>1</b> Protected mechanism extremely resistant to mechanical wear, protected against dirt inside the outer housing</p>       | <p><b>6</b> No need for manual reset to zero thanks to the wear-free triggering cam system. The measuring element is only under load while force is being applied.</p> |
| <p><b>2</b> Easily readable double scale. The colour differentiation between the N m and ft.lb scales simplifies fine setting</p> | <p><b>7</b> The square drive enables a broad range of tightening tools</p>   |
| <p><b>3</b> Two-component handle made of extremely tough, impact resistant plastic with a kind-to-the-hands softer layer</p>      | <p><b>8</b> Rapid adjustment from outside, no disassembly of the torque wrench</p>   |
| <p><b>4</b> Ring scale with fine settings for the black measuring range on the twin scale</p>                                     | <p><b>9</b> QuickRelease safety lock<br/>Firm locking and rapid change of insert tools thanks o the QuickRelease safety lock</p>                                       |
| <p><b>5</b> QuickSelect rapid setting: Pull, set, lock. All using the one setting knob</p>  | <p><b>10</b> Integrated clockwise and anticlockwise operation simply by turning over the wrench and insert tool</p>  |



## Service MANOSKOP® 730N

Clicking torque wrench with mount for interchangeable socket tools, rapid, accurate setting using QuickSelect quick-action adjuster, with QuickRelease safety lock, double stop signals, very clear twin scales with colour coded N m/ft.lb and ft.lb/inch.lb. markings and long-term repeated accuracy.

The measuring element is only under load while force is being applied, no need for manual reset to zero. All the sensitive components are protected by the sturdy housing. The 2-component handle with its ergonomically designed green softer layers is resistant to oils, grease, fuels, brake fluids and Skydrol. If the wrench is misused – e.g. to force seized-up screws – the measuring mechanism is deactivated. The swap-over inserts can also be used to apply torque in an anticlockwise direction. Easily adjustable without disassembly, e.g. using testers No-798, No-799 or No-7707 W. Guaranteed maximum accuracy deviation  $\pm 3\%$ . With certificate.

### 730N Basic wrenches with tool carrier for insert tools



SW Code	Item Code	Size					Fine scale 		b mm	h mm	L mm	L <sub>F</sub> mm	S <sub>F</sub> mm	$\Delta$ g
50 18 10 02	708887 <sup>^</sup>	2	2 - 20 N m	20 - 180 in.lb	1 N m	10 in.lb	0.2 N m	9x12	28	23	275	226	17.5	737
50 18 10 05	708889	5	10 - 50 N m	7 - 37 ft.lb	5 N m	1 ft.lb	0.25 N m	9x12	28	23	330	280.5	17.5	831
50 18 10 10	708884 <sup>^</sup>	10	20 - 100 N m	15 - 75 ft.lb	10 N m	2.5 ft.lb	0.5 N m	9x12	28	23	386	336	17.5	988
50 18 10 12	708885	12	25 - 130 N m	20 - 95 ft.lb	10 N m	2.5 ft.lb	0.5 N m	14x18	28	23	421	379	25	1128
50 18 10 20	708886	20	40 - 200 N m	30 - 150 ft.lb	10 N m	5 ft.lb	1 N m	14x18	28	23	467	424.5	25	1264
50 18 10 40	708888	40	80 - 400 N m	60 - 300 ft.lb	20 N m	10 ft.lb	2 N m	14x18	28	23	607	564.5	25	1655
50 18 10 65	708890	65	130 - 650 N m	100 - 480 ft.lb	50 N m	20 ft.lb	2.5 N m	14x18	30.6	25.6	890	848	25	3231

Refer inserts on page 63-64

SW Code	Item Code	Size					Fine scale 		b mm	h mm	L mm	L <sub>F</sub> mm	S <sub>F</sub> mm	$\Delta$ g
50 58 10 02	708892 <sup>^</sup>	a/2	20 - 180 in.lb	1.5 - 15 ft.lb	10 in.lb	0.5 ft.lb	2 in.lb	9 x 12	28	23	275	226	17.5	737
50 58 10 05	708895 <sup>^</sup>	a/5	90 - 450 in.lb	7 - 37 ft.lb	50 in.lb	1 ft.lb	2.5 in.lb	9 x 12	28	23	330	280.5	17.5	831
50 58 10 10	708891 <sup>^</sup>	a/10	180 - 900 in.lb	15 - 75 ft.lb	100 in.lb	2.5 ft.lb	5 in.lb	9 x 12	28	23	386	336	17.5	988
50 58 10 20	708893 <sup>^</sup>	a/20	350 - 1800 in.lb	30 - 150 ft.lb	100 in.lb	5 ft.lb	10 in.lb	14 x 18	28	23	467	424.5	25	1264
50 58 10 40	708894 <sup>^</sup>	a/40	60 - 300 ft.lb	800 - 3600 in.lb	20 ft.lb	100 in.lb	2 ft.lb	14 x 18	28	23	607	564.5	25	1655

Refer inserts on page 63-64

### 730NR Basic wrenches with permanently installed ratchets

in sturdy plastic case. Deviation of indication  $\pm 4\%$ .



SW Code	Item Code	Size					Fine scale 		b <sub>1</sub> mm	b <sub>2</sub> mm	h <sub>1</sub> mm	h <sub>2</sub> mm	L mm	L <sub>F</sub> mm	$\Delta$ g	$\Delta$ g with box
96 50 21 05	708900 <sup>^</sup>	5QR FK*	10 - 50 N m	7 - 37 ft.lb	5 N m	1 ft.lb	0.25 N m	3/8"	28	29	23	14.5	372.5	291	961	1386
96 50 21 10	708897 <sup>^</sup>	10QR FK*	20 - 100 N m	15 - 75 ft.lb	10 N m	2.5 ft.lb	0.5 N m	1/2"	28	29	23	14.5	428.5	346.5	1129	1554
96 50 21 20	708898 <sup>^</sup>	20QR FK*	40 - 200 N m	30 - 150 ft.lb	10 N m	5 ft.lb	1 N m	1/2"	28	41	23	18	526	438	1589	2014
96 50 21 40	708899 <sup>^</sup>	40 FK	80 - 400 N m	60 - 300 ft.lb	20 N m	10 ft.lb	2 N m	3/4"	28	50	23	30.7	657	564.5	2122	2657

\* Ratchet has quick-release safety lock

## Service MANOSKOP® 730

Torque wrenches offering quick adjustment, with cut-out, with QuickRelease safety lock (size 5-65) dual signal (size 2-40), dual scale N m/ft.lb. resp. N m/inch.lb. (size 5-80), long term accuracy and facility to accept insert/shell tools.

The robust steel tube completely encloses all working parts. Even when misused (slackening sized bolts for example), the measuring element remains stress free. Reversible insert/shell tools allow anticlockwise operation.

Recalibration, without dismantling, with the aid of checking gauges No-798, No-799 or No-7707 W.

Guaranteed accuracy ± 4%. With certificate.

### 730

#### Basic wrenches with tool carrier for insert tools

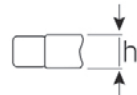
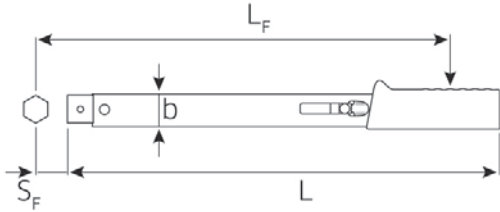

730/2

SW Code	Item Code	Size					b mm	h mm	L mm	L <sub>F</sub> mm	S <sub>F</sub> mm		
50 18 00 02	708862	2	4 - 20 N m	0.5 N m			9x12	27.5	23	178.5	174	17.5	315
50 18 00 04	708864 <sup>^</sup>	4	8 - 40 N m	1 N m			9x12	27.5	23	222	218	17.5	395

Refer inserts on page 63-64

SW Code	Item Code	Size					b mm	h mm	L mm	L <sub>F</sub> mm	S <sub>F</sub> mm		
50 58 00 02	708872 <sup>^</sup>	a/2	30 - 175 in.lb	5 in.lb			9x12	27.5	23	178.5	174	17.5	315
50 58 00 04	708874 <sup>^</sup>	a/4	70 - 350 in.lb	10 in.lb			9x12	27.5	23	222	218	17.5	395

Refer inserts on page 63-64

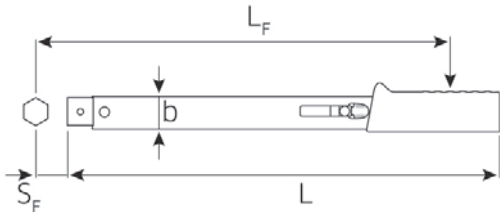

730/5

SW Code	Item Code	Size					b mm	h mm	L mm	L <sub>F</sub> mm	S <sub>F</sub> mm		
50 18 00 05	708866	5	6 - 50 N m	5 - 36 ft.lb	2 N m	1 ft.lb	9x12	28	23	315	288	17.5	805
50 18 00 10	708860	10	20 - 100 N m	15 - 72.5 ft.lb	2.5 N m	2.5 ft.lb	9x12	28	23	370	343	17.5	965
50 18 00 12	708861 <sup>^</sup>	12	25 - 130 N m	20 - 95 ft.lb	2.5 N m	2.5 ft.lb	14 x 18	28	23	410	390	25	1100
50 18 00 20	708863	20	40 - 200 N m	30 - 145 ft.lb	5 N m	5 ft.lb	14 x 18	28	23	455	435	25	1250
50 18 00 40	708865	40	80 - 400 N m	60 - 300 ft.lb	10 N m	10 ft.lb	14 x 18	28	23	590	570	25	1880
50 18 00 65	708867	65	130 - 650 N m	100 - 480 ft.lb	20 N m	20 ft.lb	14 x 18	30.6	25.6	875	855	25	3280

Refer inserts on page 63-64

### 730

#### Basic wrench with tool carrier for shell tools, registered design

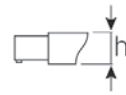
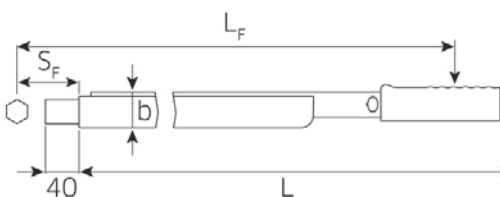

SW Code	Item Code	Size					b mm	h mm	L mm	L <sub>F</sub> mm	S <sub>F</sub> mm		
50 18 00 80	708868 <sup>^</sup>	80	160 - 800 N m	120 - 600 ft.lb	20 N m	20 ft.lb	24.5x28	46	43	970	990	95	5377

Use shell adaptor No-7370/80 to make 14 x 18-mm insert tools fit.

## Standard MANOSKOP® 721

Torque wrenches with dual "Stop" signal and cut-out, rapid adjustment, dual scale N m/ft.lb and long service life. Robust steel tube protects all working parts, even if misused, i.e. attempting to free seized metal fasteners, the measuring element remains stress free. Recalibration, without dismantling, with the aid of checking gauges No-798, No-799 or No-7707 W.

Guaranteed accuracy  $\pm 4\%$ . With certificate.

### 721 Torque wrenches with reversible ratchet

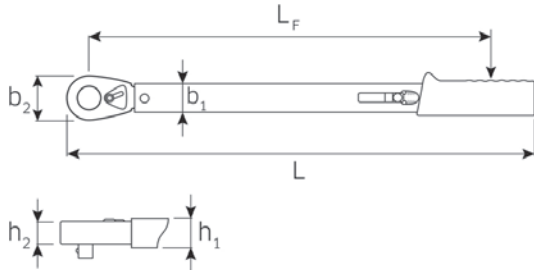

SW Code	Item Code	Size					■ "	b <sub>1</sub> mm	b <sub>2</sub> mm	h <sub>1</sub> mm	h <sub>2</sub> mm	L mm	L <sub>F</sub> mm	△ g
50 20 00 05	708842 <sup>^</sup>	5	6 - 50 N m	5 - 36 ft.lb	2 N m	1 ft.lb	3/8	28	27.5	23	14.5	352	293	900
50 20 00 15	708839 <sup>^</sup>	15	30 - 150 N m	25 - 110 ft.lb	5 N m	5 ft.lb	1/2	28	41	23	18	452	387	1395
50 20 00 30	708841 <sup>^</sup>	30	60 - 300 N m	50 - 220 ft.lb	10 N m	10 ft.lb	1/2	28	44	23	27.5	553	486	1720

size 30 with push through square drive

## Standard MANOSKOP® 721Nf

Torque wrenches with dual "STOP" signal and cut-out, micrometer type adjustment, dual scale N m/ft.lb and long service life.

Robust steel tube and light alloy "U"-profile protect all working parts.

Push through square drive for right and left hand tightening.

Recalibration without dismantling. Guaranteed accuracy  $\pm 4\%$ . With certificate.

### 721Nf Torque wrenches with ratchet

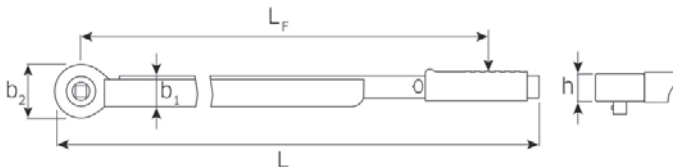

SW Code	Item Code	Size					■ "	b <sub>1</sub> mm	b <sub>2</sub> mm	h mm	L mm	L <sub>F</sub> mm	△ g
50 20 00 81	708850 <sup>^</sup>	80	160 - 800 N m	120 - 600 ft.lb	20 N m	20 ft.lb	3/4	46.5	76	42	1051	938	7222
96 50 20 01	708848 <sup>^</sup>	100	200 - 1000 N m	150 - 725 ft.lb	25 N m	25 ft.lb	3/4	46.5	76	42	1504	1365	7005

# Sensotork® 713R

## Electronic torque wrench/angle-controlled wrench

Benefits at a glance:

- Angle-controlled measurements without a reference arm
- Broad measuring range (5% – 100% of rated value)
- Extremely wide range of angle measurement
- Units of measurement N m / ft.lb / in.lb
- Clockwise and anticlockwise use
- For use with all insert tools 9x12 and 14x18 mm
- QuickSelect rapid recall of predefined sets of operating parameters
- Defined sequence – a number of repeated joints can be grouped as a defined sequence
- Readings can either be directly stored, transmitted to the PC or simply displayed
- Password protection tamper proof use
- Freely selectable names for each series of test
- Various languages available
- Works-specific identifier
- Programmable via PC
- Resistant to oils, grease, fuels, brake fluids and Skydrol
- Wide range of application: -20°C to +60°C
- Meets requirements of DKD-R 3-7, Class 2
- Deviation of indication ± 1%

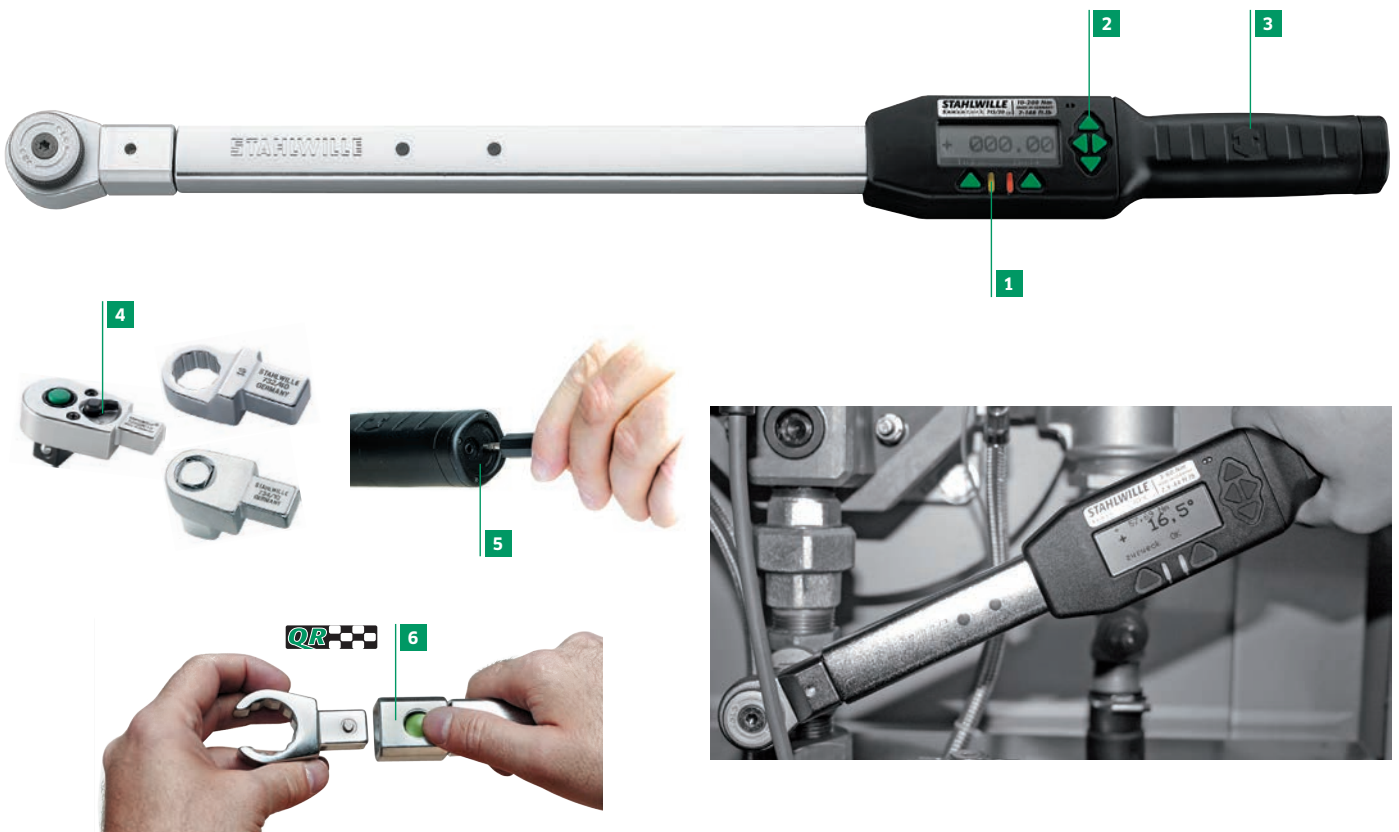

**1** Warning signals: acoustic (buzzer), tactile (vibration in the handle), visual (LEDs and display). The point at which the warning signal is triggered can be freely set

**2** Amazingly simple handling  
All functions are selected using the arrow keys. The visual guidance system makes operation a simple matter

**3** Measurements independent of the point of application of force (sizes 6 and 20)

**4** Easy extension setting  
Where the insert tool requires an extension adjustment, simply enter the new value. Recalculation using complicated formulae is no longer necessary

**5** Data output USB interface

**6** QuickRelease  
Firm locking and rapid change of any insert tools

## Electronic angle-controlled torque wrench Sensotork 713

Simple, flexible operation thanks to operator guidance on large-format display.

Very broad measuring range (5 % to 100 % of rated value) with display deviation value of  $\pm 1\%$  of the current reading. Display deviation value of angle is  $\pm 1^\circ$ .

Repeated joint can be collated to form a single menu-guided sequence.

### 713R Electronic angle-controlled torque wrenches Sensotork

Electronic angle-controlled torque wrench with insert tool pawl-action ratchet, with QuickRelease safety lock, for clockwise and anticlockwise use, readings independent of point of application of force, choice of many units of measurement, advance warning points for visual, tactile and acoustic signals, torque and angle are simultaneously visible, convenient angle measurement across a very wide angle range without a reference arm, choice of individual insert lengths, maintenance friendly due to easy adjustment and automatic reminder of next calibration date, individual identification possible, tamper-proof due to password protection, meets requirements of DKD-R 3-7, Class 2 and DIN EN ISO 6789, with works certificate in accordance with DIN EN 10204, supplied in sturdy plastic case (size 40 in sturdy steel case).

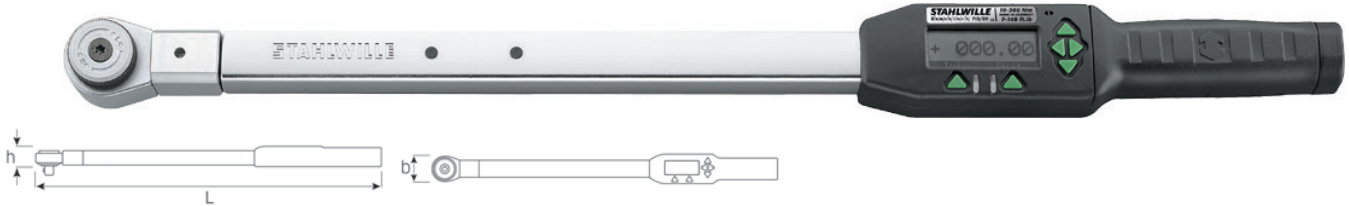

SW Code	Item Code	Size			"	mm	b mm	h mm	L mm		
96 50 16 06	708823 <sup>^</sup>	6	3 - 60 N m	2.5 - 44 ft.lb	3/8	9x12	50	33.5	378	856	1500
96 50 16 20	708821 <sup>^</sup>	20	10 - 200 N m	7 - 148 ft.lb	1/2	14 x 18	50	33.5	608	1552	2430
96 50 16 40	708822 <sup>^</sup>	40	20 - 400 N m	15 - 296 ft.lb	3/4	14 x 18	50	33.5	838	2332	5555

## Insert/shell tools for torque wrenches

### 725QR QuickRelease ratchet insert tool



reversible, with QuickRelease safety lock.  
size 4: 22 teeth, sizes 5 and 10: 30 teeth, size 20: 36 teeth

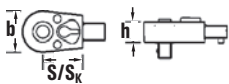

SW Code	Item Code	Size	"	mm	b mm	h mm	S mm	S <sub>k</sub> mm	
58 25 30 04	708858	4	1/4	9x12	22	14.5	17.5	40	60
58 25 30 05	708859 <sup>^</sup>	5	3/8	9x12	29	14.5	28*	100	130
58 25 30 10	708851 <sup>^</sup>	10	1/2	9x12	29	14.5	28*	100	141
58 25 30 20	708852	20	1/2	14 x 18	41	18	38.5*	200	325

Maximum continuous loads of ratchet insert tools are limited to:  
725QR/4 - 40 N m, 725QR/5 and 725QR/10 - 100 N m,  
725QR/20 - 250 N m.

Limits must not be exceeded when these insert tools are used with torque wrenches of larger capacity.

\* Caution! Modified settings on torque wrench

### 735 Ratchet insert tools

reversible, 60 teeth

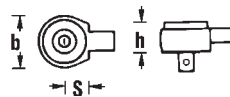

SW Code	Item Code	Size	"	mm	b mm	h mm	S mm	M N m	
58 25 00 05	709086	5	3/8	9x12	33	24	17.5	100	155
58 25 00 10	709082	10	1/2	9x12	33	24	17.5	100	147
58 25 00 20	709083	20	1/2	14 x 18	43	26	25	300	302
58 25 00 40	709084	40	3/4	14 x 18	50	32	25	400	510
58 25 00 65	800298	40HD	3/4	14 x 18	58	36	30*	650	737

Maximum continuous loads of ratchet insert tools are limited to:  
735/5 and 735/10 - 100 N m, 735/20 - 300 N m, 735/40 - 400 N m.

Limits must not be exceeded when these insert tools are used with torque wrenches of larger capacity.





# Sensotork® 7707 W

## Workshop testers

### Benefits at a glance:

- transducers can be individually recalibrated, your torque tester stays on site
- compact, can be used as a mobile laboratory (power supply is via the USB connection)
- the readings can be evaluated and digitalised inside the transducer (no external interference from a data cable)
- effect of lateral forces considerably reduced thanks to low-profile construction
- many operating modes
- automatic transducer detection
- wide range of application (-20°C to 60°C).
- acoustic overload warning
- clockwise and anticlockwise use
- broad measuring range (0.9 %-100 % of rated value)
- display deviation value up to  $\pm 0.25$  % of reading
- meets DIN 51309, Class 2, with works calibration certificate
- traceable to national standards
- solid aluminium mounting block incl. attachment for horizontal and vertical testing

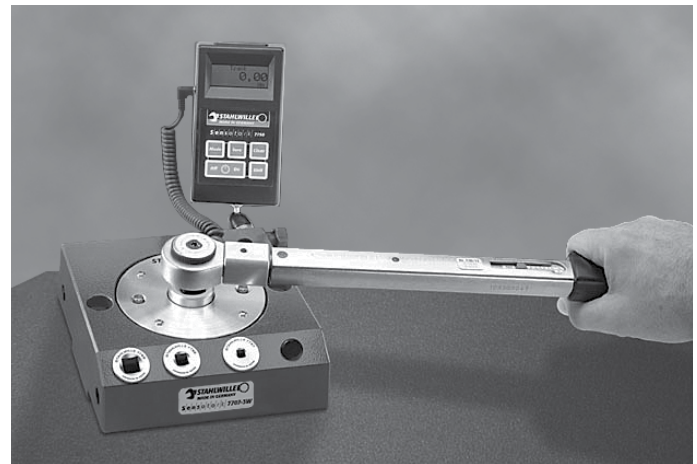

1

Displays and controls: This highly user-friendly unit can display both the preset torque value and the actual torque applied at the same time. The unit can be positioned the way it suits you best – especially convenient where the measuring axis is horizontal or if you are using the tripod supplied, which includes the cable (1.5 m).

2

Quick Release  
Rapid change and firm locking of the transducers thanks to the QuickRelease safety lock.

3

Interchangeable square drive adapters:  
A set of interchangeable square drive adapters are conveniently stored in the mounting block for a range of different drive sizes.

4

Intelligent transducers:  
The readings are fully evaluated and digitalised inside the transducer using special, integrated circuitry. As an alternative to the display unit, you can use a PC and connect the unit via a USB cable, which also allows you to perform and organise measurements and generate a calibration certificate directly.

5

Interchangeable transducers:  
The measuring range of the torque tester can be extended flexibly simply by changing the transducer for one with a different range.

## Electronic Torque Tester for torque wrenches Sensotork 7707 W

Compact workshop-based torque tester for easy adaptation by replacement of the transducers.

High degree of accuracy (from 20-100 % of the rated value  $\pm 0.25$  % display deviation from actual measured value, up to 20 % of rated value  $\pm 1$  %) thanks to flat transducer and conversion and digitalisation of readings within the transducer.

High degree of safety through display showing actual torque read-off where clicking torque wrenches are used.

### 7707 W Workshop torque tester Sensotork

Electronic workshop torque tester for torque wrenches, consisting of:

- transducer (registered design)
- holder
- display unit (registered design)
- tripod for display unit (with 1.5 m cable)
- spiral cable
- mains adaptor (220 V) or direct connection to 12 V in-car supply is possible
- square drive adaptor (No-7707-2W, No-7707-3W)
- kit for attaching the unit to a workbench or wall in a horizontal or vertical testing position

for clockwise and anticlockwise use. The easily interchangeable transducers are attached to the holder by means of a QuickRelease safety lock.

Low lateral forces thanks to low-profile transducers, automatic detection of the transducer, flexible and user friendly because the unit can be used horizontally or vertically and the display unit can be placed in many positions, additional tripod with 1.5 m cable for mounting the display unit to facilitate visual monitoring when using longer torque wrenches, especially broad measuring range from 2% to 100% of rated value ( $< 1\%$  at 1100 N m).

Readings can be transferred to PC via the USB cable (no separate power supply needed, power comes from PC). While individual transducers are being recalibrated, the torque tester itself remains on-site for further use. Wide range of application ( $-20^{\circ}\text{C}$  to  $+60^{\circ}\text{C}$ ). Meets DIN 51309, Class 2.

With works certificate in accordance with DIN EN 10204. Supplied in sturdy plastic case.

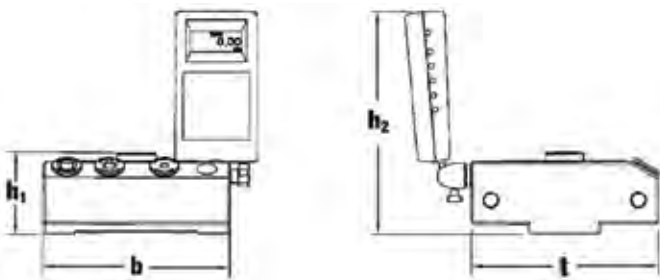

SW Code	Item Code	Size	Capacity N m	Capacity ft.lb	Capacity in.lb	Ø "	b mm	h <sub>1</sub> mm	h <sub>2</sub> mm	t mm	Δ g	Δ g with box
96 52 10 80	709166 <sup>^</sup>	7707-1W	0.4 - 20	0.3 - 15	3.5 - 177	1/4	180	79	215	180	6255	9500
96 52 10 72	709169 <sup>^</sup>	7707-2W <sup>1)</sup>	2 - 100	1.5 - 74	18 - 885	3/8	180	79	215	180	7025	10300
96 52 10 83	709167 <sup>^</sup>	7707-2-1W <sup>2)</sup>	4 - 200	3 - 148	35 - 1770	1/2	180	79	215	180	7511	10975
96 52 10 84	709168 <sup>^</sup>	7707-2-2W <sup>3)</sup>	8 - 400	6 - 295	71 - 3540	3/4	180	79	215	180	7654	11100
96 52 10 82	709170 <sup>^</sup>	7707-3W <sup>3)</sup>	25 - 1100	18 - 812	221 - 9736	3/4	180	79	215	180	7495	11000

<sup>1)</sup> with square drive adaptor No-409M (1/4"  $\square$  x 3/8"  $\blacksquare$ )

<sup>2)</sup> with square drive adaptors No-7789-4 (1/4"  $\square$  x 1/2"  $\blacksquare$ ), No-7789-5 (3/8"  $\square$  x 1/2"  $\blacksquare$ )

<sup>3)</sup> with square drive adaptors No-7787 (1/4"  $\square$  x 3/4"  $\blacksquare$ ), No-7788 (3/8"  $\square$  x 3/4"  $\blacksquare$ ), No-7789 (1/2"  $\square$  x 3/4"  $\blacksquare$ )



## Accessories for workshop torque tester

### 7721-7723 Transducers

registered design, high degree of accuracy thanks to conversion and digitalisation of readings within the transducer itself. Not susceptible to lateral forces due to low-profile construction.

Within the range of 20-100 % of rated value  $\pm 0.25$  % display deviation value from actual torque reading, up to 20 % of rated value,  $\pm 1$  %.

Can also be used as part of a calibration system.



SW Code	Item Code	No.	Capacity N m	Ø "	ΔΔ g
52 10 00 26	709172 <sup>^</sup>	7721-1	0.4 – 20	1/4	1735
52 10 00 22	709173 <sup>^</sup>	7722	2 – 100	3/8	2486
52 10 10 23	709174 <sup>^</sup>	7723-1	4 – 200	1/2	2983
52 10 20 23	709175 <sup>^</sup>	7723-2	8 – 400	3/4	3134
52 10 00 28	709176 <sup>^</sup>	7723-3	25 – 1100	3/4	2998
52 10 00 29	709177 <sup>^</sup>	7724-1	150 – 3000	1 1/2	10500

### 7751 Jack cable

Connection between transducer and USB adaptor or display unit.



SW Code	Item Code	L m	ΔΔ g
52 11 00 51	900013 <sup>^</sup>	1.5	50

### 409M Square drive adaptor

1/4" socket x 3/8" plug  
(6.3 x 10-mm).



SW Code	Item Code	L mm	Ø N m	ΔΔ g
11 03 00 10	706935	13	25	14

### 7787 Square drive adaptor

1/4" socket x 3/4" plug  
(6.3 x 20-mm).



SW Code	Item Code	L mm	Ø mm	ΔΔ g
58 52 10 87	709199 <sup>^</sup>	15.5	29	41



## Great freedom of choice – DRALL<sup>+</sup> screwdrivers



A new challenge every day, a new tool every day to meet that challenge. The DRALL<sup>+</sup> series was developed for professionals faced with new challenges on a daily basis. Development focussed on three crucial user requirements: durability and reliability, safety in use, pleasant to handle. These requirements are met in full by DRALL<sup>+</sup> screwdrivers – in fact, they feel so natural, you will hardly notice them.

The profiles

DRALL<sup>+</sup> is available for the following screwhead profiles:

- ⊖ Slotted
- ⊕ PH cross-head
- ⊕ PZ cross-head
- TORX®
- ⊕ TORX® Tamper Resistant with a central bore
- Hex with a ball-end
- ⊕ TORQ-SET®



4 handle sizes  
The handle sizes for the DRALL<sup>+</sup> screwdrivers are designed specifically to match the drive profiles.



**1**

The hand-stop helps stop injuries – Flange-like design. Supports your hand in the direction of the blade to prevent it slipping off the handle. Features integrated anti-roll shape.

**2**

The multifunctional section – The lower end of the handle is deliberately made extra-long. This enables the thumb and index finger to wrap around more easily and spin the screwdriver.

**3**

The transmission zone – The rounded cross-section in the central area combines maximum grip and easy turning.

**4**

The elastic handle components – The soft rubber textured thermoplastic elastomer (TPE) fits snugly in the hand. These sections are injection moulded around the hard core and bonded to it inseparably.

**5**

The firm handle components – The green zones are made of high-grade, impact-safe polypropylene (PP). The tang is anchored in the core to allow force to be transferred through it.

**6**

Impact-resistant cap – For use under extreme conditions, the DRALL<sup>+</sup> is also available with a one-piece shaft, an impact head and a metal impact cap.

VDE insulated screwdrivers: High-grade materials and durability testing guarantee absolute safety when working on AC systems up to 1000 V (effective voltage) or 1500 V DC.



## The power is where you put it with the 3K DRALL® screwdriver series



The efficiency with which you use a screwdriver in your daily work, and the safety with which you work, depend to a large extent on the quality of the tool. It is not just the use of high-grade materials but also the shape that matters – in particular the shape of the handles – if you want to stay in control. STAHLWILLE's 3K DRALL® screwdrivers unite these positive qualities in a manner which is close to perfect. The result is a longlife, ergonomically designed tool providing easy working combined with maximum force transmission – even with greasy hands.

3K DRALL® screwdrivers are available in sets conveniently positioned in plastic inlays or TCS safety inlays, designed for use with STAHLWILLE Tool Trolleys and Tool Boxes.



- 1** 3K DRALL® handles are made up of 3 components:  
1<sup>st</sup> component – Extremely resistant, impact-safe core made of black polypropylene (PP).
- 2** 2<sup>nd</sup> component – Soft, heat-bonded inlay made of easy-to-grip thermoplastic elastomer (TPE).
- 3** 3<sup>rd</sup> component – Two large surfaces coated with special fibres, resistant long-term to solvents to improve force transmission and work safety.
- 4** Additional Tommy-bar hole – When things get really tough, the additional Tommy-bar hole will cope with a fair amount of torque.



Blades – Made of high-grade Chrome Alloy Steel. Through-hardened. Anchored firmly in the shaft due to the extra-wide, forged tang. High resistance to bending.



Tips – Black, extremely tough, retain their shape. Whether you use the straight-bladed or Phillips type – the crosshatched blade tips will accurately transmit maximum force to the screw head.



### 4891 3K DRALL® set of screwdrivers

Set of six 3K DRALL® screwdrivers.

Content:

- ⊖ 4820: 0.6 x 3.5 x 75-mm  
0.8 x 4 x 100-mm  
1 x 5.5 x 125-mm  
1.2 x 6.5 x 150-mm
- ⊕ 4830: size 1; size 2



SW Code	Item Code	⚖️ g	📦
96 48 91 10	707757	530	1

### 4892 3K DRALL® set of screwdrivers

Set of eight 3K DRALL® screwdrivers.

Content:

- ⊖ 4820: 0.6 x 3.5 x 75 mm  
0.8 x 4 x 100 mm  
1 x 5.5 x 125 mm  
1.2 x 6.5 x 150 mm  
1.6 x 8 x 175 mm
- ⊕ 4830: size 1; size 2; size 3



SW Code	Item Code	⚖️ g	📦
96 48 92 10	707758	745	1

### 4899 3K DRALL set of TORX® screwdrivers

Set of nine 3K DRALL® screwdrivers for TORX® screws (TORX® TAMPER RESISTANT).

Content:

- ⊕ 4856: T8, T9; T10; T15; T20; T25; T27; T30; T40 (with hollow point)



SW Code	Item Code	⚖️ g	📦
96 48 99 10	707759	513	1

### TCS 4820/4830 3K DRALL® set of screwdrivers



Set of seven 3K DRALL® screwdrivers, in TCS inlay

Content:

- ⊖ 4820: 0.6 x 3.5 x 75-mm  
0.8 x 4 x 100-mm  
1 x 5.5 x 125-mm  
1.2 x 6.5 x 150-mm
- ⊕ 4830: size 1; size 2; size 3



SW Code	Item Code	⚖️ g	📦
96 83 81 84	707735 <sup>^</sup>	555	1

### 4820 3K DRALL workshop screwdrivers

DIN 5265, ISO 2380, Chrome Alloy Steel, matt chrome plated, black tips.



SW Code	Item Code	a mm	b mm	L <sub>1</sub> mm	L <sub>2</sub> mm	⚖️ g	📦
48 20 10 35	707727	0.6	3.5	75	170	23	10
48 20 10 40	707728	0.8	4	100	195	32	10
48 20 20 55	707729	1	5.5	125	220	58	10
48 20 10 65	707730	1.2	6.5	150	265	100	10
48 20 10 80	707731	1.6	8	175	290	118	10
48 20 11 00	707732	1.6	10	200	315	158	5
48 20 21 00	707733	2	12	250	375	218	5

### 4830 3K DRALL cross-head screwdrivers

Phillips-Recess®, DIN 5262, ISO 8764, Chrome Alloy Steel, matt chrome plated, black tips.



SW Code	Item Code	PH size	L <sub>1</sub> mm	L <sub>2</sub> mm	⚖️ g	📦
48 30 10 00	707736	0	60	155	28	10
48 30 10 01	707737	1	80	175	33	10
48 30 10 02	707738	2	100	215	70	10
48 30 10 03	707739	3	150	275	126	5
48 30 10 04	707740	4	200	325	251	5

### 4840 3K DRALL cross-head screwdrivers

POZIDRIV/SUPADRIV®, DIN 5262, ISO 8764, Chrome Alloy Steel, matt chrome plated, black tips.



SW Code	Item Code	PZ size	L <sub>1</sub> mm	L <sub>2</sub> mm	⚖️ g	📦
48 40 10 01	707742	1	80	175	33	10
48 40 10 02	707743	2	100	215	70	10

### 4856 3K DRALL TORX® screwdrivers

with hollow point (TORX® TAMPER RESISTANT), Chrome Alloy Steel, matt chrome plated, black tips.



SW Code	Item Code	size	⌀ mm	L <sub>1</sub> mm	L <sub>2</sub> mm	⚖️ g	📦
48 56 00 06	707753 <sup>^</sup>	T6*	1.6	50	145	45	5
48 56 00 07	707754 <sup>^</sup>	T7	2.0	50	145	37	5
48 56 00 08	707755 <sup>^</sup>	T8	2.3	60	155	50	5
48 56 00 09	707756 <sup>^</sup>	T9	2.5	60	155	50	5
48 56 00 10	707745 <sup>^</sup>	T10	2.7	80	175	26	5
48 56 00 15	707746 <sup>^</sup>	T15	3.3	80	175	52	5
48 56 00 20	707747 <sup>^</sup>	T20	3.8	100	215	32	5
48 56 00 25	707748 <sup>^</sup>	T25	4.4	100	215	55	5
48 56 00 27	707749 <sup>^</sup>	T27	5.0	115	230	58	5
48 56 00 30	707750 <sup>^</sup>	T30	5.5	115	230	63	5
48 56 00 40	707751 <sup>^</sup>	T40	6.6	115	240	86	5

\* without hollow point

### 4691 DRALL<sup>+</sup> set of Screwdrivers

Set of seven DRALL<sup>+</sup> screwdrivers.

Content:

- ⊖ 4620: size 1 (0.6 x 3.5 x 75mm)  
size 2 (0.8 x 4.0 x 100mm)  
size 3 (1.0 x 5.5 x 125mm)  
size 4 (1.2 x 6.5 x 150mm)
- ⊖ 4628: size 1 (0.4 x 2.5 x 60mm)
- ⊕ 4630: size 1; size 2



SW Code	Item Code	⚖ g	📦
96 46 91 10	707573	610	1

### 4692 DRALL<sup>+</sup> set of Screwdrivers

Set of eight DRALL<sup>+</sup> screwdrivers.

Content:

- ⊖ 4620: size 1 (0.6 x 3.5 x 75mm)  
size 2 (0.8 x 4.0 x 100mm)  
size 3 (1.0 x 5.5 x 125mm)  
size 4 (1.2 x 6.5 x 150mm)  
size 5 (1.6 x 8.0 x 175mm)
- ⊕ 4630: size 1; size 2; size 3



SW Code	Item Code	⚖ g	📦
96 46 92 10	707574	870	1

### 4693 DRALL<sup>+</sup> set of Hex Screwdrivers

Set of nine DRALL<sup>+</sup> screwdrivers.

Content:

- ⊖ 4622: size 1 (1.0 x 5.5 x 100mm)  
size 2 (1.2 x 6.5 x 125mm)  
size 3 (1.2 x 8.0 x 150mm)  
size 4 (1.6 x 10.0 x 175mm)
- ⊖ 4628: size 1 (0.4 x 2.5 x 60mm)
- ⊕ 4632: size 1; size 2
- ⊖ 4724: size 2 (1.0 x 5.5 x 25mm)
- ⊕ 4734: size 2



SW Code	Item Code	⚖ g	📦
96 46 93 10	707575	950	1

### 4694 DRALL<sup>+</sup> set of TORX<sup>®</sup> screwdrivers

Set of nine DRALL<sup>+</sup> screwdrivers for TORX<sup>®</sup> screws.

Content:

- ⊕ 4650: T8, T9, T10, T15, T20, T25, T27, T30, T40



SW Code	Item Code	⚖ g	📦
96 46 94 10	707576	730	1

### 4697 DRALL<sup>+</sup> set of screwdrivers

Set of eight DRALL<sup>+</sup> screwdrivers

Content:

- ⊖ 4620: size 1 (0.6 x 3.5 x 75mm)  
size 2 (0.8 x 4.0 x 100mm)
- ⊖ 4622: size 1 (1.0 x 5.5 x 100mm)  
size 2 (1.2 x 6.5 x 125mm)  
size 3 (1.2 x 8.0 x 150mm)
- ⊕ 4730: size 1
- ⊕ 4732: size 2, size 3



SW Code	Item Code	⚖ g	📦
96 46 97 10	707579	930	1

### 4699 DRALL<sup>+</sup> set of TORX<sup>®</sup> Screwdrivers

Set of nine DRALL<sup>+</sup> screwdrivers for TORX<sup>®</sup> screws (TORX<sup>®</sup> TAMPER RESISTANT).

Content:

- ⊕ 4656: T8, T9, T10, T15, T20, T27, T30, T40 (with hollow point)



SW Code	Item Code	⚖ g	📦
96 46 99 10	707580 <sup>^</sup>	740	1

### 4620 Workshop screwdrivers DRALL<sup>+</sup>

DIN ISO 2380 -1, -2, DIN 5264, ISO 2380-1, -2, Chrome Alloy Steel, chrome plated, black tips.



SW Code	Item Code	Size	a mm	b mm	L <sub>1</sub> mm	L <sub>2</sub> mm	⚖ g	📦
46 20 10 35	707471	1	0.6	3.5	75	160	37	10
46 20 10 40	707472	2	0.8	4	100	185	40	10
46 20 10 55	707473	3	1	5.5	125	240	79	10
46 20 10 65	707474	4	1.2	6.5	150	265	100	10
46 20 10 80	707476	5	1.6	8	175	300	136	10
46 20 11 00	707475	6	1.6	10	200	325	163	5
46 20 11 20	707477	7	2	12	250	375	215	5

### 4622 Workshop screwdrivers DRALL<sup>+</sup>

DIN ISO 2380-1, -2, DIN 5264, ISO 2380-1, -2, with hexagon, Chrome Alloy Steel, chrome plated, black tips.



SW Code	Item Code	Size	a mm	b mm	L <sub>1</sub> mm	L <sub>2</sub> mm	⚖ g	📦
46 22 10 55	707489	1	1	5.5	100	215	85	10
46 22 10 65	707490	2	1.2	6.5	125	240	100	10
46 22 10 80	707491	3	1.2	8	150	275	159	10
46 22 11 00	707492	4	1.6	10	175	300	174	10
46 22 11 20	707493	5	2	12	200	325	310	5
46 22 11 40	707494 <sup>^</sup>	6	2.5	14	250	375	331	5

### 4724 Carburettor screwdrivers DRALL

DIN 5265, ISO 2380, stubby, Chrome Alloy Steel, chrome plated, black tips.





SW Code	Item Code	Size	a mm	b mm	L <sub>1</sub> mm	L <sub>2</sub> mm	⚖ g	📦
47 24 10 45	707622 <sup>^</sup>	1	0.6	3.5	25	80	34	10
47 24 10 60	707623	2	1	5.5	25	80	32	10
47 24 10 80	707624	3	1.2	8	25	80	39	10

**4628**  **Electricians screwdrivers DRALL+**

DIN ISO 2380-1, -2, DIN 5264, ISO 2380-1, -2, Chrome Alloy Steel, chrome plated, black tips.





SW Code	Item Code	Size	a mm	b mm	L <sub>1</sub> mm	L <sub>2</sub> mm	ΔΔ g	
46 28 10 25	707496	1	0.4	2.5	60	145	38	10
46 28 10 35	707498	2	0.6	3.5	75	160	40	10
46 28 20 35	707497	3	0.6	3.5	100	185	41	10
46 28 10 40	707499	4	0.8	4.0	125	210	46	10
46 28 10 55	707500	5	1	5.5	150	265	92	10
46 28 20 55	707501 <sup>^</sup>	6	1	5.5	200	315	102	10

**4630**  **Cross-head screwdrivers DRALL+**

Phillips-Recess®, DIN ISO 8764-1, -2, ISO 8764-1, -2, Chrome Alloy Steel, chrome plated, black tips.



SW Code	Item Code	PH Size	L <sub>1</sub> mm	L <sub>2</sub> mm	ΔΔ g	
46 30 10 00	707502	0	60	145	35	10
46 30 10 01	707503	1	80	185	44	10
46 30 10 02	707504	2	100	215	90	10
46 30 10 03	707505	3	150	275	146	10

**4631**  **Cross-head screwdrivers DRALL+**

Phillips-Recess®, extra long, DIN ISO 8764-1, -2, ISO 8764-1, -2, Chrome Alloy Steel, chrome plated, black tips.





SW Code	Item Code	PH Size	L <sub>1</sub> mm	L <sub>2</sub> mm	ΔΔ g	
46 31 10 01	707506	1	250	355	110	1
46 31 10 02	707507	2	250	365	122	1

**4632**  **Cross-head screwdrivers DRALL+**

with hexagon, Phillips-Recess®, DIN ISO 8764-1, -2, ISO 8764-1, -2, Chrome Alloy Steel, chrome plated, black tips.





SW Code	Item Code	PH Size	L <sub>1</sub> mm	L <sub>2</sub> mm	ΔΔ g	
46 32 10 01	707508	1	80	185	45	10
46 32 10 02	707509	2	100	215	100	10
46 32 10 03	707510	3	150	275	170	5
46 32 10 04	707511	4	200	325	237	5

**4734**  **Cross-head screwdrivers DRALL**

Phillips-Recess®, DIN ISO 8764-1, -2, ISO 8764-1, -2, stubby, Chrome Alloy Steel, chrome plated, black tips.



SW Code	Item Code	PH Size	L <sub>1</sub> mm	L <sub>2</sub> mm	ΔΔ g	
47 34 10 01	707636 <sup>^</sup>	1	25	80	27	10
47 34 10 02	707637	2	25	80	31	10

**4640**  **Cross-head screwdrivers DRALL+**

POZIDRIV/SUPADRIV®, DIN ISO 8764-1, -2, ISO 8764-1, -2, Chrome Alloy Steel, chrome plated, black tips.





SW Code	Item Code	PZ Size	L <sub>1</sub> mm	L <sub>2</sub> mm	ΔΔ g	
46 40 10 00	707518 <sup>^</sup>	0	60	145	35	10
46 40 10 01	707519	1	80	185	44	10
46 40 10 02	707520	2	100	215	89	10
46 40 10 03	707521 <sup>^</sup>	3	150	275	145	5

**4650**  **TORX® screwdrivers DRALL+**

for inside TORX® screws, Chrome Alloy Steel, chrome plated, black tips.





SW Code	Item Code	Size	 mm	L <sub>1</sub> mm	L <sub>2</sub> mm	ΔΔ g	
46 50 10 06	707523	T6	1.6	60	145	35	5
46 50 10 07	707524	T7	2.0	60	145	35	5
46 50 10 08	707525	T8	2.3	60	145	35	5
46 50 10 09	707526	T9	2.5	60	145	35	5
46 50 10 10	707527	T10	2.7	80	165	40	5
46 50 10 15	707528	T15	3.3	80	165	38	5
46 50 10 20	707522	T20	3.8	100	205	46	5
46 50 10 25	707529	T25	4.4	100	205	50	5
46 50 10 27	707530	T27	5.0	115	230	90	5
46 50 10 30	707531	T30	5.5	115	230	90	5
46 50 10 40	707532	T40	6.6	115	240	131	5
46 50 10 45	707533 <sup>^</sup>	T45	7.8	130	255	136	5



**4650L**  **TORX® screwdrivers DRALL+**

for inside TORX® screws, extra long, Chrome Alloy Steel, chrome plated, black tips.



SW Code	Item Code	Size	 mm	L <sub>1</sub> mm	L <sub>2</sub> mm	ΔΔ g	
46 50 11 15	707534	T15	3.3	250	355	52	5
46 50 11 20	707535	T20	3.8	250	355	64	5
46 50 11 25	707536	T25	4.4	250	355	66	5
46 50 11 30	707537	T30	5.5	250	365	122	5

**Electronics Screwdrivers****4797** **Electronics screwdrivers set**

7 pieces  
Content:  
 4751:  
 size 4 (0.3 x 1.5 x 40-mm)  
 size 6 (0.4 x 2 x 60-mm)  
 size 7 (0.4 x 2.5 x 75-mm)  
 size 8 (0.5 x 3 x 75-mm)  
 4752: size 00, size 0, size 1



SW Code	Item Code	ΔΔ g	
96 47 97 10	707724	285	1

**VDE-insulated Screwdrivers**

to DIN IEC 78 (CO) 11/VDE 0680 part 201/07.83 resp. IEC 900 1987  
 AC 1000V  
 High quality materials and stringent tests guarantee safe use on "live" lines up to 1000 V or 1500 V DC. Individually tested at 10 000 V.

### 4695 VDE Screwdriver set DRALL<sup>+</sup>

Set with 6 screwdrivers DRALL<sup>+</sup>, IEC 60900 C, safety insulated.

⚡ AC 1000V

Content:

⊖ 4660 VDE:

- size 1 (0.4 x 2.5 x 75-mm)
- size 3 (0.6 x 3.5 x 100-mm)
- size 5 (1 x 5.5 x 125-mm)
- size 6 (1.2 x 6.5 x 150-mm)

⊕ 4665 VDE:

- size 1, size 2



SW Code	Item Code	⚖️ g	📦
96 46 95 10	707577	620	1

### 4660 VDE Electricians screwdrivers DRALL<sup>+</sup>

IEC 60900 C, safety insulated, blade gunmetal finished, Chrome Alloy Steel.



SW Code	Item Code	Size	a mm	b mm	L <sub>1</sub> mm	L <sub>2</sub> mm	⚖️ g	📦
46 60 10 25	707559	1	0.4	2.5	75	160	43	10
46 60 10 30	707560	2	0.5	3	100	185	39	10
46 60 10 35	707561 <sup>^</sup>	3	0.6	3.5	100	205	42	10
46 60 10 40	707562 <sup>^</sup>	4	0.8	4	100	205	46	10
46 60 10 55	707563	5	1	5.5	125	240	90	10
46 60 10 65	707564 <sup>^</sup>	6	1.2	6.5	150	265	115	10
46 60 10 80	707565 <sup>^</sup>	7	1.2	8	175	300	170	10

### 4665 VDE Cross-head screwdrivers DRALL<sup>+</sup>

Phillips-Recess<sup>®</sup>, IEC 60900 C, safety insulated, blade gunmetal finished. Chrome Alloy Steel.



SW Code	Item Code	PH Size	L <sub>1</sub> mm	L <sub>2</sub> mm	⚖️ g	📦
46 65 10 00	707566 <sup>^</sup>	0	60	145	35	10
46 65 10 01	707567 <sup>^</sup>	1	80	185	47	10
46 65 10 02	707568 <sup>^</sup>	2	100	215	89	10
46 65 10 03	707569 <sup>^</sup>	3	150	275	159	10

### 10554 EURO voltage tester

built to conform to the new EN standard, tested to conform to the currently valid VDE GS standard, with plastic handle, AC 125 - 250V.



SW Code	Item Code	a mm	b mm	L mm	⚖️ g	📦
77 45 00 01	705178 <sup>^</sup>	1	3.5	190	37	10

### 12507-2K T-handed nut spinners

with 2-component T-handle, Chrome Vanadium, matt chrome plated.

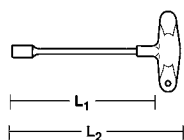

SW Code	Item Code	Ø mm	L <sub>1</sub> mm	L <sub>2</sub> mm	⚖️ g	📦
43 23 20 60	705816	6	200	224	83	10
43 23 20 70	705817	7	200	234	133	10
43 23 20 80	705818	8	200	234	135	10
43 23 20 90	705819	9	200	234	137	10
43 23 21 00	705809	10	200	234	141	10
43 23 21 10	705810	11	200	240	169	5
43 23 21 20	705811	12	200	240	171	5
43 23 21 30	705812	13	200	240	176	5

### 10546 Offset screwdrivers

DIN 5200, for slotted screws, centre handle covered with impact proof plastic, Chrome Vanadium, chrome plated.

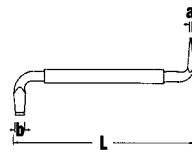

SW Code	Item Code	Size	a mm	b mm	L mm	⚖️ g	📦
73 27 20 01	705165	1	0.6	3.5	90	8	10
73 27 20 02	705166	2	0.8	4	100	12	10
73 27 20 03	705167	3	1	5.5	125	29	10
73 27 20 04	705168	4	1.2	8	150	69	10

### 10551 Offset screwdrivers

DIN 5208, for recessed head screws, Phillips-Recess<sup>®</sup>, centre handle covered with impact proof plastic, Chrome Vanadium, chrome plated.



SW Code	Item Code	Size	L mm	⚖️ g	📦
73 28 20 12	705175	1 x 2	125	30	10
73 28 20 23	705176	2 x 3	150	72	10

### Hexagon key wrenches

in holder, DIN ISO 2936 (metric), for socket head screws, Chrome Vanadium, nickel plated.



SW Code	Item Code	No.	⚖️ g	📦
96 43 15 01	705333	10760CV/9 <sup>1)</sup>	245	1
96 43 55 01	705304	10760aCV/10Pc <sup>2)</sup>	269	1
96 43 55 02	705305	10760aCV/13 <sup>3)</sup>	124	1

<sup>1)</sup> Content: 1.5; 2; 2.5; 3; 4; 5; 6; 8; 10mm

<sup>2)</sup> Content: 1/16; 5/64; 3/32; 1/8; 5/32; 3/16; 7/32; 1/4; 5/16; 3/8" (in plastic-wallet)

<sup>3)</sup> Content (in two holders): 0.028; 0.035; 0.050; 1/16; 5/64; 3/32; 7/64; 1/8; 9/64; 5/32; 3/16; 7/32; 1/4"

### 10765/9 Hexagon key wrenches

for socket head screws, DIN ISO 2936, extra long, in holder, Chrome Vanadium, nickel plated.



SW Code	Item Code	⚖️ g	📦
96 43 21 01	705354 <sup>^</sup>	410	5

### 10760CV ● Hexagon key wrenches

DIN ISO 2936 (metric), for socket head screws,  
Chrome Vanadium, nickel plated (sizes 0.7; 0.9; 1.3mm, gunmetal finish)



SW Code	Item Code	⌀ mm/"	L <sub>1</sub> mm	L <sub>2</sub> mm	g	⊞
43 15 00 70	705306 <sup>^</sup>	0.7/0.028	8	32	1	10
43 15 00 90	705307 <sup>^</sup>	0.9/0.035	10	32	1	10
43 15 01 30	705308 <sup>^</sup>	1.3/0.050	12	40	1	10
43 15 01 50	705309 <sup>^</sup>	1.5	14	45	1	10
43 15 00 02	705316 <sup>^</sup>	2	16	50	2	10
43 15 02 50	705317 <sup>^</sup>	2.5	18	56	3	10
43 15 00 03	705321 <sup>^</sup>	3	20	63	4	10
43 15 03 50	705322 <sup>^</sup>	3.5	22	66	7	10
43 15 00 04	705326 <sup>^</sup>	4	25	70	10	10
43 15 00 05	705327 <sup>^</sup>	5	28	80	18	10
43 15 00 06	705328 <sup>^</sup>	6	32	90	29	10
43 15 00 07	705329 <sup>^</sup>	7	34	95	42	10
43 15 00 08	705330 <sup>^</sup>	8	36	100	59	10
43 15 00 09	705331	9	38	105	80	10
43 15 00 10	705310 <sup>^</sup>	10	40	112	103	10
43 15 00 11	705311 <sup>^</sup>	11	42	119	130	10
43 15 00 12	705312 <sup>^</sup>	12	45	125	169	5
43 15 00 14	705313 <sup>^</sup>	14	56	140	261	5
43 15 00 17	705314 <sup>^</sup>	17	63	160	442	5
43 15 00 19	705315 <sup>^</sup>	19	70	180	603	5
43 15 00 22	705318 <sup>^</sup>	22	80	200	938	1
43 15 00 24	705319 <sup>^</sup>	24	90	224	1248	1
43 15 00 27	705320 <sup>^</sup>	27	100	250	1692	1
43 15 00 30	705323 <sup>^</sup>	30	112	280	2434	1
43 15 00 32	705324 <sup>^</sup>	32	125	315	3117	1
43 15 00 36	705325 <sup>^</sup>	36	140	355	4430	1

### Ball ended hexagon key wrenches

in holder,  
Chrome Vanadium,  
gunmetal finish.



SW Code	Item Code	No.	g	⊞
96 43 26 01	705389	10767/9 <sup>1)</sup>	420	5
96 43 57 01	705405 <sup>^</sup>	10767a/8 <sup>2)</sup>	283	1
96 43 57 02	705404	10767a/13 <sup>3)</sup>	455	1

<sup>1)</sup> Content: 1.5; 2; 2.5; 3; 4; 5; 6; 8; 10mm

<sup>2)</sup> Content: 5/64; 3/32; 1/8; 5/32; 3/16; 7/32; 1/4; 5/16"

<sup>3)</sup> Content: 0.050; 1/16; 5/64; 3/32; 7/64; 1/8; 9/64; 5/32; 3/16; 7/32; 1/4; 5/16; 3/8"

### 10767 ● Ball ended hexagon key wrenches

for hexagon socket head screws,  
with ball end on long arm,  
swivel angle up to 25° each side,  
Chrome Vanadium, gunmetal finish.



SW Code	Item Code	⌀ mm/"	L <sub>1</sub> mm	L <sub>2</sub> mm	g	⊞
43 57 01 30	705391 <sup>^</sup>	1.3/0.050	12	72	1	10
43 26 00 15	705373 <sup>^</sup>	1.5	14	90	1.5	10
43 26 00 02	705375 <sup>^</sup>	2	16	100	3	10
43 26 00 25	705376 <sup>^</sup>	2.5	18	112	5.5	10
43 26 00 03	705377 <sup>^</sup>	3	20	126	9	10
43 26 00 04	705378 <sup>^</sup>	4	25	140	18	10
43 26 00 05	705379 <sup>^</sup>	5	28	160	31	10
43 26 00 06	705380 <sup>^</sup>	6	32	180	50	10
43 26 00 08	705381 <sup>^</sup>	8	36	200	100	10
43 26 00 10	705374 <sup>^</sup>	10	40	224	188	10
43 26 00 12	705390 <sup>^</sup>	12	45	224	297	10

### 10767H/9 ● Set: Ball ended hexagon key wrenches

for recessed hexagonal screws,  
swivel angle up to 25° each side,  
from size 3-mm with ring,  
with ball end on long arm facilitates  
quick, safe work in awkward  
places, screws stay on the head  
once attached, in holder, Chrome  
Vanadium, gunmetal finish.



Content: 1.5; 2; 2.5; 3; 4; 5; 6; 8; 10-mm

SW Code	Item Code	⊞ g	⊞
96 43 26 02	705388	401	5

### 10768-2K ● Hexagon key wrenches

with 2-component T-handle, for socket head screws, with two tips,  
Chrome Vanadium, matt chrome plated, black tips.

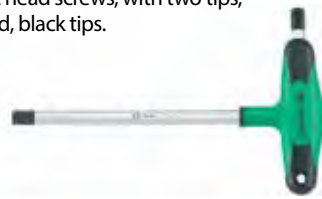
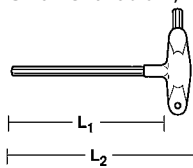

SW Code	Item Code	⌀ mm	L <sub>1</sub> mm	L <sub>2</sub> mm	g	⊞
43 25 20 20	705411	2	100	125	33	10
43 25 20 25	705412	2.5	100	125	42	10
43 25 20 30	705413	3	150	174	42	10
43 25 20 40	705414	4	150	176	51	10
43 25 20 50	705415	5	200	227	73	10
43 25 20 60	705416 <sup>^</sup>	6	200	228	92	10
43 25 20 80	705417	8	200	235	178	5
43 25 21 00	705410	10	200	235	247	5

### 10768 ● T-handled screwdrivers

for socket head screws, Chrome  
Vanadium, matt chrome plated,  
black tips.



SW Code	Item Code	⌀ mm	L <sub>1</sub> mm	L <sub>2</sub> mm	g	⊞
43 25 00 20	705408 <sup>^</sup>	2	100	116	10	10
43 25 00 25	705409 <sup>^</sup>	2.5	100	116	10	10
43 25 00 30	705418 <sup>^</sup>	3	150	166	20	10
43 25 00 40	705419 <sup>^</sup>	4	150	175	40	10
43 25 00 50	705420 <sup>^</sup>	5	200	225	60	10
43 25 00 60	705421 <sup>^</sup>	6	200	225	80	10
43 25 00 80	705422 <sup>^</sup>	8	200	235	150	5
43 25 01 00	705407 <sup>^</sup>	10	200	235	210	5

### 10769 ● TORX® T-handled screwdrivers

for inside TORX® screws, shaft nickel  
plated and chrome plated, tips  
hardened, Chrome Vanadium,  
matt chrome plated, black tips.



SW Code	Item Code	Size	⌀ mm	L <sub>1</sub> mm	L <sub>2</sub> mm	g	⊞
43 29 00 08	705433	T8	2.3	80	96	10	5
43 29 00 09	705434	T9	2.5	80	96	10	5
43 29 00 10	705423	T10	2.7	100	116	10	5
43 29 00 15	705424	T15	3.3	100	116	20	10
43 29 00 20	705425	T20	3.8	100	125	30	10
43 29 00 25	705426	T25	4.4	110	135	40	10
43 29 00 27	705427	T27	5	110	135	50	10
43 29 00 30	705428	T30	5.5	130	155	60	10
43 29 00 40	705429	T40	6.6	130	165	100	10
43 29 00 45	705430	T45	7.8	130	165	120	10
43 29 00 50	705431 <sup>^</sup>	T50	8.8	130	165	140	5





## Accurate. Strong. Dependable.

### STAHLWILLE pliers, cutters and wrenches

For accurate work and a powerful grip – with comfy-fit multi-component handles. When you are working with pliers, your hand needs optimum support and protection in the places where the pressure exerted on the hand is felt most keenly – through ergonomic handle design. STAHLWILLE has integrated softer layers in these sections of the handles. In this way, they fulfil two important functions. They prevent the hand slipping off the handle and, at the same time, absorb the shock produced when hard wires are cut. Even with oily or greasy hands, the textured surface ensures you still have a good grip on things. The special plastic we have used is also resistant to aggressive fluids and, at the end of the lifecycle, can be properly disposed of, because it does not contain PVC.

**1**

Accurate gripping! By using high-grade materials and applying our sophisticated manufacturing techniques, we are able to achieve remarkable accurately shaped jaws.

**2**

Clean, effortless cutting! Thanks to specially hardened, high-precision cutters.

**3**

Strain-free working and longer tool lifetimes! Thanks to smooth-action lap-joints.

**4**

Prevents injuries! The anti-slip protection prevents your hands slipping off towards the jaws.

**5**

Longer tool lifetime and resistance to aggressive fluids! Thanks to impact-resistant, extremely hard-wearing special plastic.

**6**

No pinch marks and strain-free working! The ergonomically positioned softer layers improve force transmission.

## 6501 Combination Pliers

DIN ISO 5746, precision cutter for all wires, incl. piano wire, induction hardened cutting edges, approx. 62 HRC, for long life.



6501 5 200



6501 6 200

SW Code	Item Code	L mm	Head	Handles	③	④	⑤	⑥	⊗ g
65 01 51 80	708440	180	chrome plated	multi-component handles with softer layers	2	1.8	12	16	235
65 01 52 00	708441	200	chrome plated	multi-component handles with softer layers	2.5	2	13	16	368
65 01 61 80	708443	180	polished	dip-coated with sure-grip surface	2	1.8	12	16	190
65 01 62 00	708444 <sup>^</sup>	200	polished	dip-coated with sure-grip surface	2.5	2	13	16	263

③ cutting capacity in mm for hard wire  
⑤ cutting capacity in mm for cable

④ cutting capacity in mm for piano wire  
⑥ cutting capacity in mm<sup>2</sup> for cable

## 6529 Snipe Nose Pliers with Cutter

DIN ISO 5745, Form A (straight), half round, long tapering, serrated jaws, with burner hole, precision cutting edges for soft and hard wires, induction hardened cutting edges, approx. 60 HRC.



6529 5 200



6529 6 200

SW Code	Item Code	L mm	Head	Handles	L <sub>3</sub> mm	W mm	D mm	h mm	b mm	⊗ g
65 29 51 60	708506 <sup>^</sup>	160	chrome plated	multi-component handles with softer layers	51	16	9	3	2.5	170
65 29 52 00	708507	200	chrome plated	multi-component handles with softer layers	73	17	9	3	2.5	220
65 29 61 60	708509	160	polished	dip-coated with sure-grip surface	51	16	9	3	2.5	148
65 29 62 00	708510 <sup>^</sup>	200	polished	dip-coated with sure-grip surface	73	17	9	3	2.5	187

## 6530 Snipe Nose Pliers with Cutter (radio- or telephone pliers)

DIN ISO 5745, Form B, bent 45°, half round, long tapering, serrated jaws, with burner hole, precision cutting edges for soft and hard wires, induction hardened cutting edges, approx. 60 HRC.



6530 5 200



6530 6 200

SW Code	Item Code	L mm	Head	Handles	L <sub>2</sub> mm	L <sub>3</sub> mm	W mm	D mm	h mm	b mm	⊗ g
65 30 51 60	708517 <sup>^</sup>	160	chrome plated	multi-component handles with softer layers	24	55	16	9	3	2.5	170
65 30 52 00	708518 <sup>^</sup>	200	chrome plated	multi-component handles with softer layers	28	76	17	9	3.5	3	220
65 30 61 60	708519 <sup>^</sup>	160	polished	dip-coated with sure-grip surface	24	55	16	9	3	2.5	146
65 30 62 00	708520 <sup>^</sup>	200	polished	dip-coated with sure-grip surface	28	76	17	9	3.5	3	178

## 6534 Mechanics snipe nose pliers

Form A (straight), half round, long tapering, serrated jaws.



6534 5 280

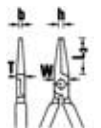

SW Code	Item Code	L mm	Head	Handles	L <sub>3</sub> mm	W mm	D mm	h mm	b mm	⊗ g
65 34 52 80	708543 <sup>^</sup>	280	chrome plated	dip-coated with sure-grip surface	73	20	9.5	3	2.5	255

## 6535 Mechanics snipe nose pliers

Form B (bent 45°), half round, long tapering, serrated jaws.



6535 5 280

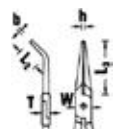

SW Code	Item Code	L mm	Head	Handles	L <sub>2</sub> mm	L <sub>3</sub> mm	W mm	D mm	h mm	b mm	⊗ g
65 35 52 80	708546 <sup>^</sup>	280	chrome plated	dip-coated with sure-grip surface	28	66	20	9.5	3	2.5	255

## 6600 Side cutters ✂

DIN ISO 5749, Form B, precision cutting edges for all wires incl. piano wire, high quality alloy steel, bevelled cutting edges induction hardened, approx. 63 HRC.



SW Code	Item Code	L mm	Head	Handles	e mm	h mm	b mm	①	②	③	④	g
66 00 51 60	708674	160	chrome plated	multi-component handles with softer layers	29,5	22,5	9,5	3	2,8	2	1,6	205
66 00 51 80	708675	180	chrome plated	multi-component handles with softer layers	32	23,5	11	3,8	3	2,5	2	325
66 00 61 60	708679	160	polished	dip-coated with sure-grip surface	29,5	22,5	9,5	3	2,8	2	1,6	165
66 00 61 80	708680 <sup>^</sup>	180	polished	dip-coated with sure-grip surface	32	23,5	11	3,8	3	2,5	2	205

① cutting capacity in mm for soft wire      ② cutting capacity in mm for medium hard wire  
 ③ cutting capacity in mm for hard wire      ④ cutting capacity in mm for piano wire

## 6602 Heavy Duty Side cutters ✂

DIN ISO 5749, Form A, precision cutting edges for all wires incl. piano wire, high quality alloy steel, bevelled cutting edges induction hardened, approx. 63 HRC.



SW Code	Item Code	L mm	Head	Handles	e mm	h mm	b mm	①	②	③	④	g
66 02 52 00	708697 <sup>^</sup>	200	chrome plated	multi-component handles with softer layers	31	28	11,5	4	4	3	2,5	310
66 02 52 50	708698 <sup>^</sup>	250	chrome plated	multi-component handles with softer layers	32	29,5	12	4	4	3,5	3	400
66 02 62 00	708702 <sup>^</sup>	200	polished	dip-coated with sure-grip surface	31	28	11,5	4	4	3	2,5	260
66 02 62 50	708703	250	polished	dip-coated with sure-grip surface	32	29,5	12	4	4	3,5	3	375

① cutting capacity in mm for soft wire      ② cutting capacity in mm for medium hard wire  
 ③ cutting capacity in mm for hard wire      ④ cutting capacity in mm for piano wire

## 6618 Top cutters, heavy duty ✂

DIN ISO 5748, precision cutting edges for all wires, incl. piano wire, alloy steel of highest quality, induction hardened bevelled cutting edges, approx. 63 HRC.



SW Code	Item Code	L mm	Head	Handles	e mm	h mm	b <sub>1</sub> mm	b <sub>2</sub> mm	①	②	③	④	g
66 18 51 60	708743 <sup>^</sup>	160	chrome plated	multi-component handles with softer layers	17	26	11,5	24	3,8	3	2,5	2	240
66 18 61 60	708744 <sup>^</sup>	160	polished	dip-coated with sure-grip surface	17	26	11,5	24	3,8	3	2,5	2	225

① cutting capacity in mm for soft wire      ② cutting capacity in mm for medium hard wire  
 ③ cutting capacity in mm for hard wire      ④ cutting capacity in mm for piano wire

## 6622 Wire stripping pliers

with adjustment screw to cut insulation only on wire or cable, max. 5 mm Ø10 mm<sup>2</sup> conductor cross-section.



SW Code	Item Code	L mm	Head	Handles	g
66 22 61 60	708755 <sup>^</sup>	160	polished	dip-coated with sure-grip surface	180

## 6551 Waterpump pliers

DIN ISO 8976 (No 207 c), box joint, 7 adjustment positions, anti-squeeze protection, Chrome Vanadium.



SW Code	Item Code	L mm	Jaw Opening max mm	Head	Handles	g
65 51 62 40	708606	240	43	black lacquered, jaws polished	black lacquered, box frame polished, dip-coated	330
65 51 63 00	708607 <sup>^</sup>	300	51	black lacquered, jaws polished	dip-coated with sure-grip surface	520

### 6563 Universal self grip wrenches

forged jaws (one straight, one contoured), quick release lever, Chrome Vanadium.



6563 2 250

SW Code	Item Code	L mm	S mm	Head	Handles	g
65 63 21 75	708633 <sup>^</sup>	175	25	bright nickel-plated	bright nickel-plated	320
65 63 22 50	708634 <sup>^</sup>	250	30	bright nickel-plated	bright nickel-plated	500

### 6564 Self grip wrenches

forged contoured jaws, quick release lever, wire cutter, Chrome Vanadium.



6564 2 300

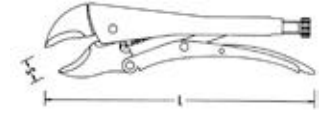

SW Code	Item Code	L mm	S mm	Head	Handles	g
65 64 21 75	708636 <sup>^</sup>	175	30	bright nickel-plated	bright nickel-plated	323
65 64 22 50	708637 <sup>^</sup>	250	40	bright nickel-plated	bright nickel-plated	550
65 64 23 00	708638	300	65	bright nickel-plated	bright nickel-plated	977

### 6576N Connector pliers

replaceable plastic jaws, 4 adj. positions, for use on screw connections incl. Canon-connectors, or any light alloy or other tube connections, surfaces of which must not be damaged, Chrome Vanadium.



6576 5 231

SW Code	Item Code	L mm	Head	Handles	g
65 76 52 31	708655	230	chrome plated	dip-coated	288

### 6660 Steel fixers pincers

DIN ISO 9242, limit on opening angle to ensure single-handed closure (registered design), little effort required due to optimised cutter geometry, induction-hardened cutters provide excellent resistance to wear, special steel, drop-forged, oil hardened



6660 1 280

SW Code	Item Code	L mm	Head	Handles	g
66 60 12 50	708773 <sup>^</sup>	250	polished	black lacquered	420
66 60 12 80	708774 <sup>^</sup>	280	polished	black lacquered	434

### 6630 Cable shear

for copper and light alloy cables. Easy, single handed operation. Special cutting edges geometry to avoid pressure marks and frayed ends, adjustable joint, anti-squeeze protection, not suitable for steel or armoured cables.



6630 7 220

SW Code	Item Code	L mm	Head	Handles	⑦	⑧	⑨	g
66 30 72 20	708765 <sup>^</sup>	220	chrome plated	dip-coated with sure-grip surface	16	35	70	332

⑦ cutting capacity in mm<sup>2</sup> for single wire Al-/Cu-Cable  
⑨ cutting capacity in mm<sup>2</sup> for thin wire Al-/Cu-Cable

⑧ cutting capacity in mm<sup>2</sup> for multiple wire Al-/Cu-Cable

### 6543 Circlip pliers for inside circlips

DIN 5256 C, straight, H.D. drop forged, precision points.



65436004

SW Code	Item Code	Size	L mm	Tips Ø mm	For Circlip Sizes mm	Head	Handles	△ g
65 43 60 00	708566 <sup>^</sup>	J 0	140	0.9	8-13	polished	dip-coated with sure-grip surface	100
65 43 60 01	708567 <sup>^</sup>	J 1	140	1.3	12-25	polished	dip-coated with sure-grip surface	100
65 43 60 02	708568 <sup>^</sup>	J 2	180	1.8	19-60	polished	dip-coated with sure-grip surface	150
65 43 60 03	708569 <sup>^</sup>	J 3	225	2.3	40-100	polished	dip-coated with sure-grip surface	215
65 43 60 04	708570 <sup>^</sup>	J 4	320	3.2	85-140	polished	dip-coated with sure-grip surface	462

### 6544 Circlip pliers for inside circlips

DIN 5256 D, bent 90°, H.D. drop forged, precision points.



65446041

SW Code	Item Code	Size	L mm	Tips Ø mm	For Circlip Sizes mm	Head	Handles	△ g
65 44 60 01	708578 <sup>^</sup>	J 01	130	0.9	8-13	polished	dip-coated with sure-grip surface	100
65 44 60 11	708579 <sup>^</sup>	J 11	130	1.3	12-25	polished	dip-coated with sure-grip surface	100
65 44 60 21	708580 <sup>^</sup>	J 21	170	1.8	19-60	polished	dip-coated with sure-grip surface	150
65 44 60 31	708581 <sup>^</sup>	J 31	215	2.3	40-100	polished	dip-coated with sure-grip surface	215
65 44 60 41	708582 <sup>^</sup>	J 41	300	3.2	85-140	polished	dip-coated with sure-grip surface	432

### 6545 Circlip pliers for outside circlips

DIN 5254 A, straight, H.D. drop forged, precision points, with wear resistant compression spring.



65456004

SW Code	Item Code	Size	L mm	Tips Ø mm	For Circlip Sizes mm	Head	Handles	△ g
65 45 60 00	708588 <sup>^</sup>	A 0	140	0.9	3-10	polished	dip-coated with sure-grip surface	105
65 45 60 01	708589 <sup>^</sup>	A 1	140	1.3	10-25	polished	dip-coated with sure-grip surface	105
65 45 60 02	708590 <sup>^</sup>	A 2	180	1.8	19-60	polished	dip-coated with sure-grip surface	160
65 45 60 03	708591 <sup>^</sup>	A 3	210	2.3	40-100	polished	dip-coated with sure-grip surface	232
65 45 60 04	708592 <sup>^</sup>	A 4	315	3.2	85-140	polished	dip-coated with sure-grip surface	491

### 6546 Circlip pliers for outside circlips

DIN 5254 B, bent 90°, H.D. drop forged, precision points, with wear resistant compression spring.



65466041

SW Code	Item Code	Size	L mm	Tips Ø mm	For Circlip Sizes mm	Head	Handles	△ g
65 46 60 01	708598 <sup>^</sup>	A 01	125	0.9	3-10	polished	dip-coated with sure-grip surface	105
65 46 60 11	708599 <sup>^</sup>	A 11	125	1.3	10-25	polished	dip-coated with sure-grip surface	105
65 46 60 21	708600 <sup>^</sup>	A 21	170	1.8	19-60	polished	dip-coated with sure-grip surface	160
65 46 60 31	708601 <sup>^</sup>	A 31	200	2.3	40-100	polished	dip-coated with sure-grip surface	236
65 46 60 41	708602 <sup>^</sup>	A 41	290	3.2	85-140	polished	dip-coated with sure-grip surface	468

## 6575 Wire twisting pliers

registered design, for wire locking of metal fasteners, with side cutter, serrated jaws for positive grip, jaws angled by 40°, suitable for locking wires up to  $\varnothing$  1.6 mm (dec. in. 0.06), **for clockwise and anti-clockwise use**, with automatic return action, Chrome Vanadium.



6575 1 220



6575 1 280

SW Code	Item Code	L mm	Head	Handles	g
65 75 12 20	708652	230	gunmetal finish, polished	gunmetal finish	330
65 75 12 80	708654	280	gunmetal finish, polished	gunmetal finish	440

## 6501 VDE Combination pliers

DIN ISO 5746, precision cutting edges for all wires, incl. piano wire, induction hardened cutting edges, approx. 62 HRC, for long life.



6501 8 200

SW Code	Item Code	L mm	Head	Handles	③	④	⑤	⑥	g
65 01 82 00	708448 <sup>^</sup>	200	chrome plated	insulated, with plastic sleeves, DIN EN 60900,  AC/1000 V	2.5	2	13	16	317

③ cutting capacity in mm for hard wire      ④ cutting capacity in mm for piano wire  
 ⑤ cutting capacity in mm for cable      ⑥ cutting capacity in mm<sup>2</sup> for cable

## 6529 VDE Snipe nose pliers with cutter (radio- or telephone pliers)

DIN ISO 5745, Form A (straight), half round, long tapering, serrated jaws, with burner hole, precision cutting edges for soft and hard wires, induction hardened cutting edges, approx. 60 HRC.



6529 8 200

SW Code	Item Code	L mm	Head	Handles	L <sub>3</sub> mm	W mm	D mm	h mm	b mm	g
65 29 82 00	708513 <sup>^</sup>	200	chrome plated	insulated, with plastic sleeves, DIN EN 60900,  AC/1000 V	73	17	9	3	2.5	202

## 6530 VDE Snipe nose pliers with cutter (radio- or telephone pliers)

DIN ISO 5745, Form B, bent 45°, half round, long tapering, serrated jaws, with burner hole, precision cutting edges for soft and hard wires, induction hardened cutting edges, approx. 60 HRC.



6530 8 200

SW Code	Item Code	L mm	Head	Handles	L <sub>2</sub> mm	L <sub>3</sub> mm	W mm	D mm	h mm	b mm	g
65 30 82 00	708524 <sup>^</sup>	200	chrome plated	insulated, with plastic sleeves, DIN EN 60900,  AC/1000 V	28	76	17	9	3.5	3	201

## 6600 VDE Side cutters

DIN ISO 5749, Form B, precision cutting edges for all wires incl. piano wire, high quality alloy steel, bevelled cutting edges, induction hardened, approx. 63 HRC.



6600 8 180



SW Code	Item Code	L mm	Head	Handles	e mm	h mm	b mm	①	②	③	④	g
66 00 81 80	708686 <sup>^</sup>	180	chrome plated	insulated, with plastic sleeves, DIN EN 60900,  AC/1000 V	25.5	25	9.5	3.8	3	2.5	2	249

① cutting capacity in mm for soft wire      ② cutting capacity in mm for medium hard wire  
 ③ cutting capacity in mm for hard wire      ④ cutting capacity in mm for piano wire

## 6602 VDE Heavy Duty Side cutters

DIN ISO 5749, Form A, precision cutting edges for all wires incl. piano wire, high quality alloy steel, bevelled cutting edges induction hardened, approx. 63 HRC.

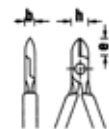

6602 8200

SW Code	Item Code	L mm	Head	Handles	e mm	h mm	b mm	①	②	③	④	g
66 02 82 00	708708 <sup>^</sup>	200	chrome plated	insulated, with plastic sleeves, DIN EN 60900,  AC/1000 V	31	28	11.5	4	4	3	2.5	305

① cutting capacity in mm for soft wire      ② cutting capacity in mm for medium hard wire  
 ③ cutting capacity in mm for hard wire      ④ cutting capacity in mm for piano wire

## 6622 VDE Wire stripping pliers

with adjustment screw to cut insulation only on wire or cable, max. 5 mm Ø 10 mm<sup>2</sup> conductor cross-section.



6622 8160

SW Code	Item Code	L mm	Head	Handles	g
66 22 81 60	708757 <sup>^</sup>	160	chrome plated	insulated, with plastic sleeves, DIN EN 60900,  AC/1000 V	168

## 6703 Set with 3 pliers, chrome plated

multi-component handles with softer layers, in plastic inlay  
Content:

- 6501 Combination pliers, 180 mm
- 6602 Heavy duty side cutter, 160 mm
- 6529 Snipe nose pliers, 200 mm



SW Code	Item Code	g
96 65 00 05	708778 <sup>^</sup>	810

## 6705 Set with 3 pliers, polished

dip-coated, in plastic inlay  
Content:

- 6551 Waterpump pliers, 240 mm, lacquered
- 6501 Combination pliers, 180 mm
- 6602 Heavy duty side cutter, 160 mm



SW Code	Item Code	g
96 65 00 07	708780 <sup>^</sup>	880

## 6704 Set with 3 pliers, chrome plated

multi-component handles with softer layers (No 6501, 6602), in plastic inlay  
Content:

- 6551 Waterpump pliers, 240 mm
- 6501 Combination pliers, 180 mm
- 6602 Heavy duty side cutter, 160 mm



SW Code	Item Code	g
96 65 00 06	708779 <sup>^</sup>	950

## 6706 Set with 3 pliers, polished

dip-coated, in plastic inlay  
Content:

- 6501 Combination pliers, 180 mm
- 6602 Heavy duty side cutter, 160 mm
- 6529 Snipe nose pliers, 200 mm



SW Code	Item Code	g
96 65 00 08	708781 <sup>^</sup>	750



# Specialty Tools

## 10955 Plastic hammers

with interchangeable heads of impact resisting Cellulose Acetate and Ash Handles.



SW Code	Item Code	∅ mm	L <sub>1</sub> mm	L <sub>2</sub> mm	⚖ g	📦
70 16 00 27	705524 <sup>^</sup>	27	265	90	215	6
70 16 00 32	705525	32	280	100	325	6
70 16 00 35	705526	35	290	105	400	2
70 16 00 40	705527	40	320	110	550	2
70 16 00 50	705528 <sup>^</sup>	50	340	115	860	2

## 10955R Spare plastic heads

of impact resisting Cellulose Acetate, these are lightly heated and then tapped into position.

SW Code	Item Code	∅ mm	⚖ g	📦
79 04 00 35	705532 <sup>^</sup>	35	28	10
79 04 00 40	705533 <sup>^</sup>	40	37	10
79 04 00 50	705534 <sup>^</sup>	50	65	10

## 10960 Engineers hammers

with Ash Handles, DIN 1041.

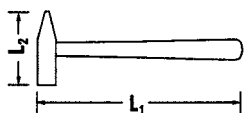

SW Code	Item Code	g	L <sub>1</sub> mm	L <sub>2</sub> mm	⚖ g	📦
70 11 00 05	705561	100	260	82	148	6
70 11 00 01	705564	200	280	95	254	6
70 11 00 04	705565	300	300	105	396	6
70 11 00 02	705566	500	320	118	614	6
70 11 00 06	705567	800	350	130	951	2
70 11 00 03	705560	1000	360	135	1132	2
70 11 00 07	705562	1500	380	145	1615	2
70 11 00 08	705563	2000	400	155	2285	2

## 10970 Ball pein hammers

with Ash Handles.



SW Code	Item Code	lb.	L <sub>1</sub> mm	L <sub>2</sub> mm	⚖ g	📦
70 12 00 01	705570	1/4	270	67	176	6
70 12 00 05	705569	1/2	290	82	320	6
70 12 00 06	705573	3/4	310	93	454	6
70 12 00 02	705571	1	320	99	575	6
70 12 00 04	705568	1 1/2	350	118	790	2
70 12 00 03	705572	2	380	126	1044	2

## 100 Ribbed cold chisels

of tough tempered special steel, chrome plated.



SW Code	Item Code	Size	L mm	b mm	⚖ g	📦
70 01 00 05	705074	5*	125	18	93	10
70 01 00 06	705075	6	150	20	165	10
70 01 00 08	705076	8	200	26	305	5
70 01 00 10	705072	10	250	30	507	5
70 01 00 12	705073	12	300	35	807	5

\* to be discontinued

## 102 Cold chisels

DIN 6453, Chrome Vanadium Steel, lacquered silver.



SW Code	Item Code	Size	L mm	b mm	⚖ g	📦
70 02 00 02	705082	125	125	15	96	10
70 02 00 03	705083	150	150	18	172	10
70 02 00 04	705084	175	175	21	269	10
70 02 00 05	705085	200	200	24	379	5
70 02 00 07	705086	250	250	25	479	5
70 02 00 08	705087	300	300	26	591	5

## 110 Grooving chisel

flat, Chrome Vanadium Steel, lacquered silver.



SW Code	Item Code	L mm	b mm	⚖ g	📦
70 08 00 01	705580	240	26	292	5

## 112 Grooving chisel

as No-110, but with finger protector.



SW Code	Item Code	L mm	b mm	⚖ g	📦
70 08 00 02	705651 <sup>^</sup>	240	26	411	5

## 112/1 Finger protector

for Cold Chisels No-102 and Cross-cut Chisels No-103 from 200-mm onward, for Grooving Chisel No 110, shaft section 23 x 13-mm.

SW Code	Item Code	⚖ g	📦
79 16 00 01	705652 <sup>^</sup>	101	5



### 105 Centre punches

DIN 7250, octagonal,  
Chrome Vanadium, lacquered silver.



SW Code	Item Code	Size	mm	L mm	△△ g	☐
70 05 00 01	705132	100 x 10	10	100	52	10
70 05 00 05	705133	120 x 10	10	120	63	10
70 05 00 02	705134	120 x 12	12	120	90	10

### 109 Pin punches

with guide bush.



SW Code	Item Code	Size	● mm	● mm	L mm	△△ g	☐
70 09 00 01	705498	1	0.9	5	80	7	10
70 09 00 02	705499	2	1.4	5.5	82	12	10
70 09 00 03	705500 <sup>^</sup>	3	1.8	6	86	12	10
70 09 00 04	705501 <sup>^</sup>	4	2.4	7	95	18	10
70 09 00 05	705502 <sup>^</sup>	5	2.8	7	97	19	10
70 09 00 06	705503 <sup>^</sup>	6	3.4	8	100	25	10
70 09 00 07	705504 <sup>^</sup>	7	3.9	9	100	27	10
70 09 00 08	705505 <sup>^</sup>	8*	5.9	10	103	47	10

● diameter of tip  
● diameter of handle  
\* without guide bush

### 102-5/6 Sets: Chisels, pins, punches

6 pieces  
content: 1 each  
No-106/125-mm  
No-106/150-mm  
No-107/125-mm  
No-104/120 x 2; 120 x 4-mm  
No-105/120 x 10-mm  
D = in plastic stand  
Pc = in plastic wallet



SW Code	Item Code	No.	△△ g	☐
98 81 22 01	705097 <sup>^</sup>	102-5/6 D	445	1
98 81 22 02	705098	102-5/6 Pc	426	5

### 105-8/6K Pin punch - centre punch set

6 pieces  
in transparent plastic  
container stand.  
Content: 1 each  
No-108/150 x 2.5; 150 x 3; 150 x 4;  
150 x 5; 150 x 6-mm;  
DIN 6450/ Form C  
No-105/120 x 10-mm; DIN 7250



SW Code	Item Code	No.	△△ g	☐
96 70 07 11	705181	105-8/6K	483	1

### 108/6 Sets: Parallel pin punches

6 pieces  
Content: 1 each  
No-108/150 x 2.5; 150 x 3; 150 x 4;  
150 x 5; 150 x 6; 150 x 8-mm  
D = in plastic stand  
Pc = in plastic wallet



SW Code	Item Code	No.	△△ g	☐
96 70 07 01	705471 <sup>^</sup>	108/6 D	450	1
96 70 07 02	705472	108/6 Pc	424	5

### 10670 Three square engineers scrapers

special steel.



SW Code	Item Code	L mm	△△ g	☐
72 06 01 01	705209 <sup>^</sup>	215	106	5
72 06 01 03	705211 <sup>^</sup>	265	124	5
72 06 01 04	705212 <sup>^</sup>	285	140	5
72 06 01 05	705213 <sup>^</sup>	310	152	5

### 10676 Three square engineers bearing scraper

special steel.



SW Code	Item Code	L mm	△△ g	☐
72 08 01 03	705218 <sup>^</sup>	85 x 12 x 315	160	5

### 12050 Tubular hacksaw

with blade size 300-mm/12".



SW Code	Item Code	L mm	△△ g	☐
72 21 00 00	705725 <sup>^</sup>	465	490	1

### 12053 Hacksaw frame



SW Code	Item Code	L mm	△△ g	☐
72 21 00 02	705727	252	159	1

### Spare hacksaw blades for No-12053

6 pieces, Chrome Alloy Tool Steel, 32 teeth per inch.

SW Code	Item Code	L mm	△△ g	☐
79 18 00 02	705728 <sup>^</sup>	158	23	1

### 905/25 Stud remover set

M 5 - M 16, 3/16" - 5/8", 25 pieces, in green plastic box.

Content:  
5 HSS twist drills sizes (3.2; 4.8; 6.4; 8; 8.7-mm)  
5 Fluted Removal Pins sizes 1-5 for threads M 5-M 16  
5 Splined Nuts, sizes 1-5  
10 Drill Guides, sizes 1-10



SW Code	Item Code	△△	📦
		g	
96 71 30 25	709395	555	1

### 906 Spare parts

Removal pins and splined nuts, in pairs in plastic bags.

SW Code	Item Code	Size	for threads	△△	📦
				g	
71 31 00 01	709396	1	M5-M6 3/16 - 1/4"	14	1
71 31 00 02	709397	2	M7-M8 1/4 - 5/16"	20	1
71 31 00 03	709398	3	M10 3/8"	33	1
71 31 00 04	709399	4	M12 7/16"	46	1
71 31 00 05	709400	5	M14-M16 1/2 - 9/16"	65	1

### 12665 52 Screw pitch gauge

0.25 to 6-mm and 4 to 62 t.p.i. (metric/Whitworth threads).



SW Code	Item Code	Size	△△	📦
			g	
77 27 00 03	705847	52	79	10

### 13110 Steel rule

Metric-Inch scales, length 300-mm.



SW Code	Item Code	Divisions Top Edge "	Divisions Lower Edge mm	△△	📦
				g	
77 46 00 01	706085 <sup>^</sup>	1/16, 1/32, 1/64	0.5; 1	26	5

### 12915 Ratchet tap holders

steel, chrome plated



SW Code	Item Code	Size	Capacity mm	DIN 1)	ISO 2)	L mm	△△	📦
							g	
77 39 00 01	705895	1	2.0-5.0	M3-8	M1-6	85	180	1
77 39 00 02	705896	2	4.6-8	M5-12	M6-12	110	305	1

1) for taps DIN

2) for taps ISO

### 12800 Set warding files

6 pieces, in Pc-wallet, DIN 7283, Content: 1 file each, hand, flat, half round, three square, square, round



SW Code	Item Code	L mm	△△	📦
			g	
72 23 00 01	705881	100	111	5

### 13100 Set of needle files

6 pieces, in plastic wallet, Content: 1 file each, round, half round, three square, square, hand, flat



SW Code	Item Code	L mm	△△	📦
			g	
96 72 28 01	706084 <sup>^</sup>	140	46	1

### 12321 Engineers scriber

with knurled centre section. 1 straight and 1 offset blade; blades gunmetal finished.



SW Code	Item Code	L mm	△△	📦
			g	
77 10 00 00	705749	250	31	10

### 12374 Wire brush

wood, steel wire dia. 0.35-mm.



SW Code	Item Code	L mm	Rows	△△	📦
				g	
77 09 00 00	705753	290	4	129	10

### 12377 Wire brush

with brass coated steel bristles.



SW Code	Item Code	L mm	△△	📦
			g	
77 09 00 10	705755	270	140	24

### 12378 File brush



SW Code	Item Code	L mm	△△	📦
			g	
77 25 00 00	705756	260	74	5

### 13115 Brass wire brush

for use on light alloys.



SW Code	Item Code	L mm	Rows	△△	📦
				g	
77 47 00 01	706086	280	4	134	1

## 12481 Scraper



SW Code	Item Code	L mm	b mm	⚖️ g	📦
77 07 00 00	705761	212	60	65	10

## 10356 Scraper

for removing residues of adhesive and stickers from vehicle glass. Blade 40mm wide, 0.3mm thick, interchangeable with cover



SW Code	Item Code	Length mm	Width mm	⚖️ g	📦
74 27 00 05	705114	165	40	90	1

## 12600 Magnetic lifters

loss of adhesion above 80°C



SW Code	Item Code	Lifting power g	∅ mm	L mm	⚖️ g	📦
77 26 00 27	705822	270 <sup>1)</sup>	5	500	25	1
77 26 00 25	705824	500	8	460	80	1
77 26 00 60	705821 <sup>^</sup>	1800	15	520	230	1
77 26 02 00	705823 <sup>^</sup>	3000	19	535	297	1

<sup>1)</sup> Miniature magnetic lifter with tiny head, very powerful

## 12910 Adjustable hook spanners

for slotted nuts as per DIN 1810, adjustable.



SW Code	Item Code	Size	∅ mm	⚖️ g	📦
44 01 00 01	705892	1	20-42	90	5
44 01 00 02	705893	2	45-90	245	5
44 01 00 03	705894	3	95-165	686	5

## 12921N Telescopic mirror



SW Code	Item Code	mm	L mm	⚖️ g	📦
77 40 10 30	705902 <sup>^</sup>	30	265-705	108	1
77 40 10 40	705903	40	275-715	112	1
77 40 10 50	705904 <sup>^</sup>	50	285-725	135	1
77 40 10 60	705905 <sup>^</sup>	60	295-735	150	1

## 12922 Claw lifter

with ergonomic handle.



SW Code	Item Code	∅ mm	L mm	⚖️ g	📦
77 40 11 03	705910 <sup>^</sup>	6	540	113	1

## Special tools for ignition and electrics



### 12375 Spark plug brush

wood, brass wire dia 0.15mm.



SW Code	Item Code	L mm	Rows	⚖️ g	📦
74 16 00 01	705754	150	3 x 5	18	10

### 12905 Car circuit tester

for car electrics 6-12 volt and 24 volt, with pointed probe, cover cap, connecting lead with alligator clip.



SW Code	Item Code	L mm	⚖️ g	📦
77 38 00 01	705890	120	73	10

## Special tools for carburetors



### 10506 Screwdriver

for setting correct CO-valve on mixture screen, idling mixture on Pierburg carburetors: BMW, Ford, Opel, Peugeot, Renault, Mercedes-Benz cars. Choke adjustment Audi 80, VW Passat 1.3-1.5; 1.6 l, matt chrome, black tip.



SW Code	Item Code	L mm	blade mm	⚖️ g	📦
73 01 00 01	705136	350	0.8 x 4 x 300	53	10

### 10518 Screwdriver

for adjustment (slotted screws), matt chrome, black tip.



SW Code	Item Code	L mm	blade mm	⚖️ g	📦
73 21 01 02	705141	515	1 x 5.5 x 410	159	10

### 11085 Jet reamers

16 pieces in case, with holder



SW Code	Item Code	measuring range mm	⚖️ g	📦
74 31 00 01	705647	0.33 - 2.0	27	10





## Special tools for valves and pistons

### 11095-11097 Precision feeler gauges

DIN 1544F, nickel-plated case, tapered blades.



SW Code	Item Code	No.	Sizes	L mm	g		
74 24 00 01	705648	11095/13	0.05; 0.10; 0.15; 0.20; 0.25; 0.30; 0.40; 0.50; 0.60; 0.70; 0.80; 0.90; 1.00mm	100	61		10
74 24 00 02	705649	11095/20	0.05; 0.10; 0.15; 0.20; 0.25; 0.30; 0.35; 0.40; 0.45; 0.50; 0.55; 0.60; 0.65; 0.70; 0.75; 0.80; 0.85; 0.90; 0.95; 1.00mm	100	95		10
74 24 00 05	705650	11097/26	1 1/2; 2; 2 1/2; 3; 4; 5; 6; 7; 8; 9; 10; 11; 12; 13; 14; 15; 16; 17; 18; 19; 20; 21; 22; 23; 24; 25/1000"	100	80		10





## Special tools for brakes and wheels

### Tyre levers

Handy, sturdy construction, purposefully shaped, Chrome Alloy Steel





SW Code	Item Code	No.	L mm	g		
74 01 04 00	706720^	39 cars	400	383		5
74 01 06 00	706721^	39/1 HGVs	600	897		5
74 01 06 02	706722^	39/2 HGVs	600	1172		5
74 01 06 03	706723^	39/3 HGVs	600	915		5

### 12373 Steel wire brush

special slim design



SW Code	Item Code	L mm	Rows	g		
77 44 00 01	705752	230	2	70		10





## Special tools for lubrication service

### 3045 Special socket

for oil filters, size 74-mm, 14-point, 10-mm dia. bore and outside hexagon 22-mm Ø.



SW Code	Item Code	total height mm	g		
74 37 00 01	706671	52	131		1

# Koken

## High Performance Tools of Convincing Quality

Ko-ken Tools is a specialist manufacturer of Premium Quality Sockets and Socket Accessories that are made in Japan.

Product development resulting in improved patented designs is a vital part of Ko-ken's philosophy.

The result has been continual improvements in the durability, appearance and functionality of all tools bearing the Ko-ken name.

Ko-ken prides itself in producing tools that exceed recognised DIN ISO manufacturing standards.

Sophisticated production facilities using CAD design with computer controlled lathes, machine tools and cold forming techniques guarantee superior quality.



**168P**  Screwdrivers

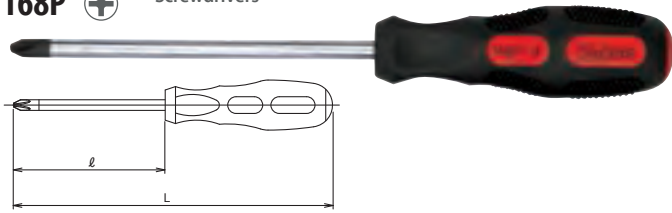

Item Code	Part No.	168P (PH)	ℓ (mm)	L (mm)	(g)	(pcs.)
504069	KO168P1	1	75	175	59	6
504070	KO168P2	2	100	210	86	6
504071	KO168P3	3	150	270	150	6

**168S**  Screwdrivers

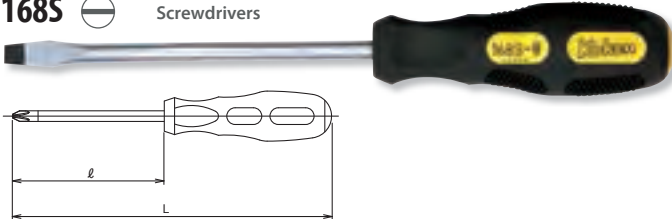

Item Code	Part No.	168 (S)	ℓ (mm)	L (mm)	(g)	(pcs.)
504073	KO168S5	5	75	175	59	6
504074	KO168S6	6	100	210	86	6
504075	KO168S8	8	150	270	150	6

**168PS/6**   Screwdriver Set



Item Code	Part No.	6 Piece Screwdriver Set	(g)
504072	KO168PS/6	 168P Screwdrivers 1, 2, 3  168S Screwdrivers 5, 6, 8	660

**166P**  Screwdrivers (Blade-Through type)

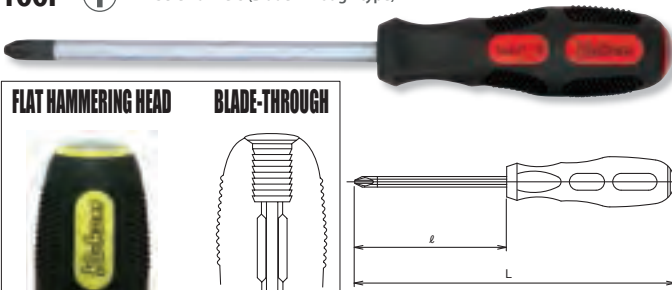

Item Code	Part No.	166P (PH)	ℓ (mm)	L (mm)	(g)	(pcs.)
504036	KO166P1	1	75	175	78	6
504037	KO166P2	2	100	210	129	6
504038	KO166P3	3	150	270	203	6

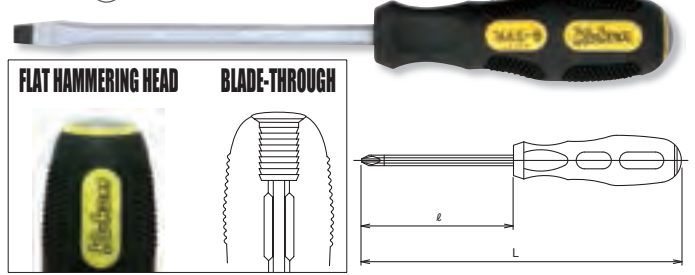

**166S**  Screwdrivers (Blade-Through type)



Item Code	Part No.	166S	ℓ (mm)	L (mm)	(g)	(pcs.)
504040	KO166S5	5	75	175	78	6
504041	KO166S6	6	100	210	129	6
504042	KO166S8	8	150	270	203	6

**166PS/6**   Screwdriver Set (Blade Through Type)



Item Code	Part No.	6 Piece Screwdriver Set	(g)
504039	KO166PS/6	 166P Screwdrivers 1, 2, 3  166S Screwdrivers 5, 6, 8	885

**168T (TH)**  Tamper-Resistant TORX® Screwdrivers 

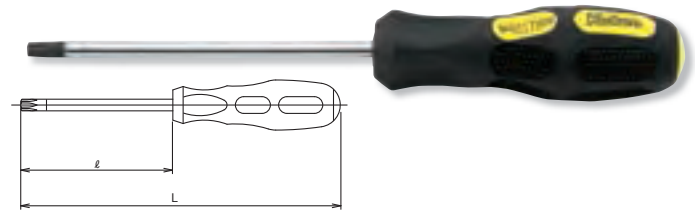

Item Code	Part No.	168T (TH)	ℓ (mm)	L (mm)	(g)	(pcs.)
504077^	KO168T-T10H	T10H	80	150	25	6
504078^	KO168T-T15H	T15H	80	150	25	6
504079^	KO168T-T20H	T20H	125	225	60	6
504080^	KO168T-T25H	T25H	125	225	60	6
504081^	KO168T-T27H	T27H	125	235	90	6
504082^	KO168T-T30H	T30H	125	235	92	6
504083^	KO168T-T40H	T40H	125	245	153	6

 Tamper Resistant TORX® Screwdrivers have less strength due to the special design. Make sure to use it correctly.

**168T/7 (TH)**  Tamper-Resistant Torx® Screwdriver Set 



Item Code	Part No.	168T	(g)
504076	KO168T/7	7 Piece Set 168T: T10H, T15H, T20H, T25H, T27H, T30H, T40H	480

### 167M

Socket Drivers (Spin-Tites)

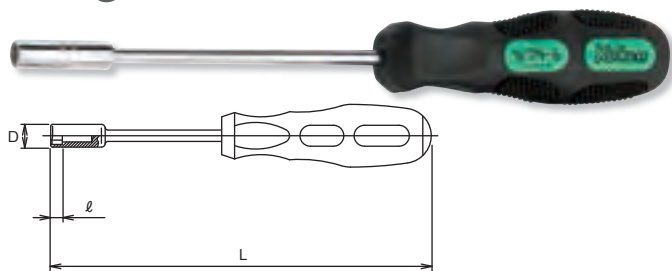

Item Code	Part No.	167M (mm)	D (mm)	l (mm)	L (mm)	(g)	(pcs.)
504049	KO167M03	3	5.8	3	225	62	6
504050	KO167M03.5	3.5	5.8	3	225	62	6
504051	KO167M04	4	6.7	3.5	225	64	6
504052	KO167M04.5	4.5	7.2	4.5	225	65	6
504053	KO167M05	5	7.8	5	225	66	6
504054	KO167M05.5	5.5	8.4	5.5	225	68	6
504055	KO167M06	6	9.1	6	225	70	6
504056	KO167M07	7	10.9	6.5	235	101	6
504057	KO167M08	8	12	7	235	103	6
504058	KO167M10	10	14.5	8	235	111	6
504059	KO167M12	12	16.8	9	245	161	6
504060	KO167M13	13	18.2	9.5	245	167	6
504061	KO167M14	14	19.2	11	245	178	6

### 104M · 104A

6-Point T-Handle Wrench



Item Code	Part No.	104M (mm)	D (mm)	l (mm)	L1 (mm)	L2 (mm)	(g)	(pce.)
503610	KO104M06	6	9.5	8	200	180	150	1
503611	KO104M07	7	11	9	200	180	152	1
503612	KO104M08	8	12	10	250	200	183	1
503613	KO104M09	9	14	12	250	200	188	1
503614	KO104M10	10	14	13	250	200	230	1
503615	KO104M11	11	16	14	250	200	234	1
503616	KO104M12	12	18	15	250	250	384	1
503617	KO104M13	13	18.5	17	300	250	412	1
503618	KO104M14	14	20	18	300	250	428	1
503619	KO104M15	15	21	19	300	250	443	1
503620	KO104M17	17	24	22	350	300	707	1
503621	KO104M18	18	25	23	350	300	707	1
503622	KO104M19	19	26.5	25	350	300	717	1
503623	KO104M21	21	29	27	350	300	1070	1
503624	KO104M22	22	30	28	350	300	1062	1

Item Code	Part No.	104A (inch)	D (mm)	l (mm)	L1 (mm)	L2 (mm)	(g)	(pce.)
503603	KO104A12	3/8	14	12	250	200	188	1
503604	KO104A14	7/16	16	14	250	200	234	1
503605	KO104A16	1/2	18.5	17	300	250	412	1
503606	KO104A18	9/16	20	18	300	250	428	1
503607	KO104A20	5/8	22.5	21	350	300	528	1
503609	KO104A24	3/4	26.5	25	350	300	717	1

### AG112A

Attack (Impact) Driver Set



6 PIECE SET  
METAL CASE:W220xH82xT60mm

Item Code	Part No.	Bits	Accessories	(g)
505518	KOAG112A	100P.32 Phillips Bits 2, 3	4112G 4138	1,150
		100S.32 Slotted Bits 9, 11		

### AN112A

Attack (Impact) Driver Set

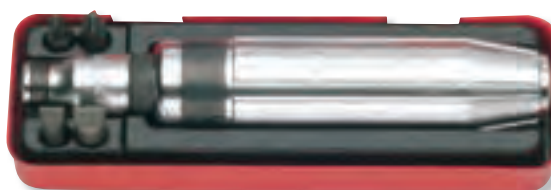

6 PIECE SET  
METAL CASE:W190xH59xT45mm

Item Code	Part No.	Bits	Accessories	(g)
505519	KOAN112A	100P.32 Phillips Bits 2, 3	4112N 4138	1,070
		100S.32 Slotted Bits 9, 11		

### AN112C

Attack (Impact) Driver Set

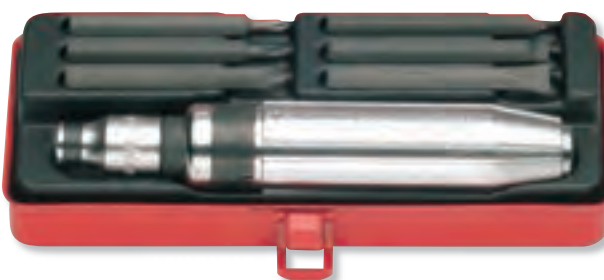

8 PIECE SET  
METAL CASE:W215xH80xT47mm

Item Code	Part No.	Bits	Accessories	(g)
505520	KOAN112C	100P.80 Phillips Bits 1, 2, 3	4112N 4138	1,350
		100S.80 Slotted Bits 7, 9, 12		



Black finished head prevents peeling off the chrome plate by striking the head.

# 5/16" Bits and Holder

## 100P-32 · -80 Phillips Bits

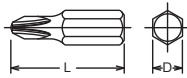

Item Code	Part No.	100P.32 (PH)	D (mm)	L (mm)	(g)	(pcs.)
503576	KO100P32/1	1	8	32	11	10
503577	KO100P32/2	2	8	32	11	10
503578	KO100P32/3	3	8	32	12	10
503579	KO100P32/4	4	8	32	12	10

Item Code	Part No.	100P.80 (PH)	D (mm)	L (mm)	(g)	(pcs.)
503580	KO100P80/1	1	8	80	30	10
503581	KO100P80/2	2	8	80	30	10
503582	KO100P80/3	3	8	80	31	10
503583	KO100P80/4	4	8	80	32	10

## 100S-32 · -80 Bits for Slotted head

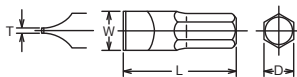

Item Code	Part No.	100S.32	T×W (mm)	D (mm)	L (mm)	(g)	(pcs.)
503584	KO100S3206	6	1 × 6	8	32	10	10
503585	KO100S3208	8	1.2× 8	8	32	12	10
503586	KO100S3209	9	1.6× 9	8	32	12	10
503587	KO100S3211	11	1.6×11	8	32	15	10
503588	KO100S3212	12	2 ×12	8	32	18	10
503589	KO100S3214	14	2 ×14	8	32	21	10

Item Code	Part No.	100S.80	T×W (mm)	D (mm)	L (mm)	(g)	(pcs.)
503590	KO100S8006	6	1 × 6	8	80	29	10
503591	KO100S8007	7	1 × 7	8	80	30	10
503592	KO100S8008	8	1.2× 8	8	80	31	10
503593	KO100S8009	9	1.6× 9	8	80	32	10
503594	KO100S8011	11	1.6×11	8	80	33	10
503595	KO100S8012	12	2 ×12	8	80	34	10

## 100H-32 Hex Bits

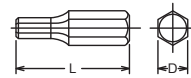

Item Code	Part No.	100H.32 (mm)	D (mm)	L (mm)	(g)	(pcs.)
503568	KO100H3203	3	8	32	11	10
503569	KO100H3204	4	8	32	11	10
503570	KO100H3205	5	8	32	12	10
503571	KO100H3206	6	8	32	12	10
503572	KO100H3208	8	8	32	13	10
503573	KO100H3210	10	8	32	16	10
503574	KO100H3212	12	8	32	23	10
503575	KO100H3214	14	8	32	29	10

## 100T-32 (T) TORX® Bits

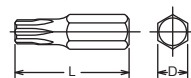

Item Code	Part No.	100T.32 (T)	D (mm)	L (mm)	(g)	(pcs.)
503596	KO100T35T10	T10	8	32	9	10
503597	KO100T35T15	T15	8	32	9	10
503598	KO100T35T20	T20	8	32	9	10
503599	KO100T35T25	T25	8	32	10	10
503600	KO100T35T27	T27	8	32	10	10
503601	KO100T35T30	T30	8	32	11	10
503602	KO100T35T40	T40	8	32	12	10

## 3138 Bit Holder

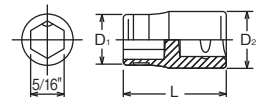

Item Code	Part No.		D <sub>1</sub> (mm)	D <sub>2</sub> (mm)	L (mm)	(g)	(pcs.)
504534	KO3138		16	18	38	55	10

## 4138 5/16" Bit Holder

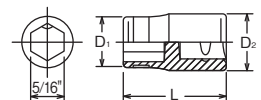

Item Code	Part No.		D <sub>1</sub> (mm)	D <sub>2</sub> (mm)	L (mm)	(g)	(pcs.)
504918	KO4138		16	22	38	62	10

Kokem



# 1/4" Sockets & Accessories

## 2400M 2400A

6-point Sockets

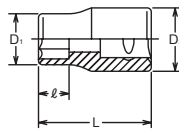

Item Code	Part No.	2400M (mm)	D <sub>1</sub> (mm)	D <sub>2</sub> (mm)	ℓ (mm)	L (mm)	(g)	(pcs.)
504326	KO2400M03	3	5.5	11.2	2.6	22	7	10
504327	KO2400M04	4	6.7	11.2	3.5	22	8	10
504328	KO2400M04.5	4.5	7.3	11.2	4	22	8	10
504329	KO2400M05	5	8	11.2	5	22	8	10
504330	KO2400M05.5	5.5	8.5	11.2	5.5	22	9	10
504331	KO2400M06	6	9.2	11.2	5.5	22	9	10
504332	KO2400M07	7	10.3	11.2	6	22	9	10
504333	KO2400M08	8	11.2	11.7	6.9	22	11	10
504334	KO2400M09	9	13	12	7.3	22	12	10
504335	KO2400M10	10	14.3	12.9	7.7	22	15	10
504336	KO2400M11	11	15.5	14.3	9.3	22	18	10
504337	KO2400M12	12	16.8	15.5	9.3	22	23	10
504338	KO2400M13	13	18	16.4	9.8	22	23	10
504339	KO2400M14	14	19.3	17.9	11	24	30	10

Item Code	Part No.	2400A (inch)	D <sub>1</sub> (mm)	D <sub>2</sub> (mm)	ℓ (mm)	L (mm)	(g)	(pcs.)
504315	KO2400A04	1/8	5.7	11.2	2.7	22	7	10
504316	KO2400A06	3/16	7.8	11.2	5	22	8	10
504317	KO2400A07	7/32	8.5	11.2	5.5	22	9	10
504318	KO2400A08	1/4	9.6	11.2	5.8	22	9	10
504319	KO2400A09	9/32	10.3	11.2	6	22	9	10
504320	KO2400A10	5/16	11.2	11.7	6.9	22	11	10
504321	KO2400A11	11/32	12.5	11.7	7.3	22	12	10
504322	KO2400A12	3/8	13.7	12.5	7.7	22	15	10
504323	KO2400A14	7/16	15.5	14.3	9.3	22	18	10
504324	KO2400A16	1/2	18	16.4	9.8	22	23	10
504325	KO2400A18	9/16	19.3	17.9	11	24	30	10

## 2405M 2405A

12-point Sockets

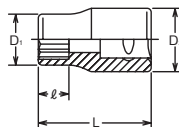

Item Code	Part No.	2405M (mm)	D <sub>1</sub> (mm)	D <sub>2</sub> (mm)	ℓ (mm)	L (mm)	(g)	(pcs.)
504351	KO2405M03	3	5.5	11.2	2.6	22	7	10
504352	KO2405M04	4	6.7	11.2	3.5	22	8	10
504353	KO2405M04.5	4.5	7.3	11.2	4	22	8	10
504354	KO2405M05	5	8	11.2	5	22	8	10
504355	KO2405M05.5	5.5	8.5	11.2	5.5	22	9	10
504356	KO2405M06	6	9.2	11.2	5.5	22	9	10
504357	KO2405M07	7	10.3	11.2	6	22	9	10
504358	KO2405M08	8	11.2	11.7	6.9	22	11	10
504359	KO2405M09	9	13	12	7.3	22	12	10
504360	KO2405M10	10	14.3	12.9	7.7	22	15	10
504361	KO2405M11	11	15.5	14.3	9.3	22	18	10
504362	KO2405M12	12	16.8	15.5	9.3	22	23	10
504363	KO2405M13	13	18	16.4	9.8	22	23	10
504364	KO2405M14	14	19.3	17.9	11	24	30	10

Item Code	Part No.	2405A (inch)	D <sub>1</sub> (mm)	D <sub>2</sub> (mm)	ℓ (mm)	L (mm)	(g)	(pcs.)
504340	KO2405A04	1/8	5.7	11.2	2.7	22	7	10
504341	KO2405A06	3/16	7.8	11.2	5	22	8	10
504342	KO2405A07	7/32	8.5	11.2	5.5	22	9	10
504343	KO2405A08	1/4	9.6	11.2	5.8	22	9	10
504344	KO2405A09	9/32	10.3	11.2	6	22	9	10
504345	KO2405A10	5/16	11.2	11.7	6.9	22	11	10
504346	KO2405A11	11/32	12.5	11.7	7.3	22	12	10
504347	KO2405A12	3/8	13.7	12.5	7.7	22	15	10
504348	KO2405A14	7/16	15.5	14.3	9.3	22	18	10
504349	KO2405A16	1/2	18	16.4	9.8	22	23	10
504350	KO2405A18	9/16	19.3	17.9	11	24	30	10

## RS2400M/11 RS2405M/11

Socket Set on Rail



Item Code	Part No.	Socket Sets	(g)
505554	KORS2400M/11	RS2400M: 11 Pieces Set/Rail 200mm 4, 5, 6, 7, 8, 9, 10, 11, 12, 13, 14	222
505557	KORS2405M/11	RS2405M: 11 Pieces Set/Rail 200mm 4, 5, 6, 7, 8, 9, 10, 11, 12, 13, 14	222

## RS2400A/9 RS2405A/9

Socket Set on Rail



Item Code	Part No.	Socket Sets	(g)
505553	KORS2400A/9	RS2400A: 9 Pieces Set/Rail 150mm 3/16, 7/32, 1/4, 9/32, 5/16, 11/32, 3/8, 7/16, 1/2"	162
505556	KORS2405A/9	RS2405A: 9 Pieces Set/Rail 150mm 3/16, 7/32, 1/4, 9/32, 5/16, 11/32, 3/8, 7/16, 1/2"	162

## RSAS2405A/10

12-point Socket Set on Rail



Item Code	Part No.	Socket Sets	(g)
505615 <sup>^</sup>	KORSAS2405A/10	RSAS2405A: 10 Pieces Set/Rail 150mm 3/16, 7/32, 1/4, 9/32, 5/16, 11/32, 3/8, 7/16, 1/2, 9/16"	160

Aerospace Standard SAE AS954

## RS2400W/9

6 Point Whitworth Socket Set on Rail



Item Code	Part No.	Socket Set	(g)
505555	KORS2400W/9	RS2400W: 9 Pieces Set/Rail 150mm 8, 7, 6, 5, 4, 3, 2, 1, 0BA	120

Across Flat	BA	8BA	7BA	6BA	5BA	4BA	3BA	2BA	1BA	0BA
	(ref. mm)	3.86	4.37	4.90	5.59	6.30	7.16	8.23	9.27	10.49
(ref. in)	0.152	0.172	0.193	0.220	0.248	0.282	0.324	0.365	0.413	

# 1/4" Sockets & Accessories

## 2415M

Double Square Sockets

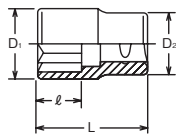

Item Code	Part No.	2415M (mm)	D <sub>1</sub> (mm)	D <sub>2</sub> (mm)	ℓ (mm)	L (mm)	(g)	(pcs.)
504368	KO2415M06	6	11	11.7	5.4	22	13	10
504369	KO2415M08	8	14.3	12.9	6.8	22	17	10
504370	KO2415M10	10	17.4	16	8.2	22	27	10

## RS2425/6

TORX<sup>®</sup> Socket Set on Rail



Item Code	Part No.	Torx Socket Set	(g)
505558	KORS2425/6	RS2425: 6 Pieces Set/Rail 150mm E4, E5, E6, E7, E8, E10	85

## 2300M

6-point Deep Sockets

### 2300A

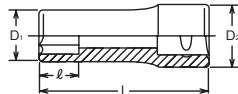

Item Code	Part No.	2300M (mm)	D <sub>1</sub> (mm)	D <sub>2</sub> (mm)	ℓ (mm)	L (mm)	(g)	(pcs.)
504277	KO2300M03	3	5.5	11.2	3	50	15	10
504278	KO2300M04	4	6.7	11.2	4	50	15	10
504279	KO2300M05	5	8	11.2	5.5	50	17	10
504280	KO2300M06	6	9.2	11.2	7	50	20	10
504281	KO2300M07	7	10.3	11.2	8	50	25	10
504282	KO2300M08	8	11.2	11.7	9	50	25	10
504283	KO2300M09	9	13	12	10	50	30	10
504284	KO2300M10	10	14.3	12.9	11	50	34	10
504285	KO2300M11	11	15.5	14.3	12	50	43	10
504286	KO2300M12	12	16.8	15.5	13	50	50	10
504287	KO2300M13	13	18	16.4	14	50	52	10
504288	KO2300M14	14	19.3	17.9	16	50	57	10

Item Code	Part No.	2300A (inch)	D <sub>1</sub> (mm)	D <sub>2</sub> (mm)	ℓ (mm)	L (mm)	(g)	(pcs.)
504266	KO2300A04	1/8	5.7	11.2	3.5	50	15	10
504267	KO2300A06	3/16	7.8	11.2	5.5	50	17	10
504268	KO2300A07	7/32	8.5	11.2	6	50	17	10
504269	KO2300A08	1/4	9.6	11.2	7	50	25	10
504270	KO2300A09	9/32	10.3	11.2	8	50	25	10
504271	KO2300A10	5/16	11.2	11.7	9	50	25	10
504272	KO2300A11	11/32	12.5	11.7	10	50	30	10
504273	KO2300A12	3/8	13.7	12.5	11	50	34	10
504274	KO2300A14	7/16	15.5	14.3	12	50	43	10
504275	KO2300A16	1/2	18	16.4	14	50	52	10
504276	KO2300A18	9/16	19.3	17.9	16	50	57	10

## 2305M

12-point Deep Sockets

### 2305A

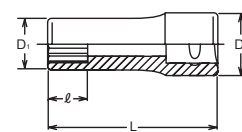

Item Code	Part No.	2305M (mm)	D <sub>1</sub> (mm)	D <sub>2</sub> (mm)	ℓ (mm)	L (mm)	(g)	(pcs.)
504300	KO2305M03	3	5.5	11.2	3	50	15	10
504301	KO2305M04	4	6.7	11.2	4	50	15	10
504302	KO2305M05	5	8	11.2	5.5	50	17	10
504303	KO2305M06	6	9.2	11.2	7	50	20	10
504304	KO2305M07	7	10.3	11.2	8	50	25	10
504305	KO2305M08	8	11.2	11.7	9	50	25	10
504306	KO2305M09	9	13	12	10	50	30	10
504307	KO2305M10	10	14.3	12.9	11	50	34	10
504308	KO2305M11	11	15.5	14.3	12	50	43	10
504309	KO2305M12	12	16.8	15.5	13	50	50	10
504310	KO2305M13	13	18	16.4	14	50	52	10
504311	KO2305M14	14	19.3	17.9	16	50	57	10

Item Code	Part No.	2305A (inch)	D <sub>1</sub> (mm)	D <sub>2</sub> (mm)	ℓ (mm)	L (mm)	(g)	(pcs.)
504289	KO2305A04	1/8	5.7	11.2	3.5	50	15	10
504290	KO2305A06	3/16	7.8	11.2	5.5	50	17	10
504291	KO2305A07	7/32	8.5	11.2	6	50	17	10
504292	KO2305A08	1/4	9.6	11.2	7	50	25	10
504293	KO2305A09	9/32	10.3	11.2	8	50	25	10
504294	KO2305A10	5/16	11.2	11.7	9	50	25	10
504295	KO2305A11	11/32	12.5	11.7	10	50	30	10
504296	KO2305A12	3/8	13.7	12.5	11	50	34	10
504297	KO2305A14	7/16	15.5	14.3	12	50	43	10
504298	KO2305A16	1/2	18	16.4	14	50	52	10
504299	KO2305A18	9/16	19.3	17.9	16	50	57	10

## RS2300M/11

Deep Socket Set on Rail

### RS2305M/11

12-point Deep Sockets



Item Code	Part No.	Socket Sets	(g)
505549	KORS2300M/11	RS2300M: 11 Pieces Set/Rail 200mm 4, 5, 6, 7, 8, 9, 10, 11, 12, 13, 14	437
505552	KORS2305M/11	RS2305M: 11 Pieces Set/Rail 200mm 4, 5, 6, 7, 8, 9, 10, 11, 12, 13, 14	437

## RS2300A/9

Socket Set on Rail

### RS2305A/9

12-point Deep Sockets



Item Code	Part No.	Socket Sets	(g)
505548	KORS2300A/9	RS2300A: 9 Pieces Set/Rail 150mm 3/16, 7/32, 1/4, 9/32, 5/16, 11/32, 3/8, 7/16, 1/2"	296
505551	KORS2305A/9	RS2305A: 9 Pieces Set/Rail 150mm 3/16, 7/32, 1/4, 9/32, 5/16, 11/32, 3/8, 7/16, 1/2"	296

Kokem

# 1/4" Sockets & Accessories

## 2274MD 2274AD

Socket Set



PLASTIC BAG

Item Code	Part No.	Socket Sets	(g)
504262	KO2274MD	2305M: 7 Piece Set 12-pt. Deep Sockets 6, 7, 8, 9, 10, 11, 12mm	245
504260	KO2274AD	2305A: 7 Piece Set 12-pt. Deep Sockets 1/4, 9/32, 5/16, 11/32, 3/8, 7/16, 1/2"	245

## 2445A

12-point Universal Sockets

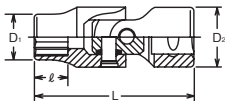

Item Code	Part No.	2445A (inch)	D <sub>1</sub> (mm)	D <sub>2</sub> (mm)	l (mm)	L (mm)	(g)	(pcs.)
504384	KO2445A08	1/4	9.8	13	6.5	33	18	10
504385	KO2445A10	5/16	11.7	13	7.5	34	19	10
504387	KO2445A12	3/8	13.7	13	8.3	35	20	10
504388	KO2445A14	7/16	15.5	13	9.5	36	21	10
504389	KO2445A16	1/2	18.8	13	10.5	37	26	10
504390	KO2445A18	9/16	19.2	13	10.5	37	28	10

## RS2445A/9

Universal 12-point Socket Set on Rail



Item Code	Part No.	Universal Drive Socket Set	(g)
505559	KORS2445A/9	RS2445A: 9 Pieces Set/Rail 150mm 3/16, 1/4, 9/32, 5/16, 11/32, 3/8, 7/16, 1/2, 9/16"	220

## 2000-28 (PH)

Phillips Bit Sockets

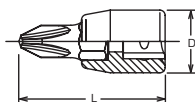

Item Code	Part No.	2000.28 (PH)	D (mm)	L (mm)	(g)	(pcs.)
504233	KO2000/1	1	12	28	10	10
504234	KO2000/2	2	12	28	11	10
504235	KO2000/3	3	12	28	12	10

## 2010M

Inhex Bit Sockets

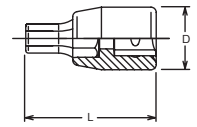

Item Code	Part No.	2010M.25 (mm)	D (mm)	L (mm)	(g)	(pcs.)
504240	KO2010M03	3	12	25	9	10
504241	KO2010M04	4	12	25	9	10
504242	KO2010M05	5	12	25	10	10
504243	KO2010M06	6	12	25	12	10
504244	KO2010M07	7	13.1	25	12	10
504245	KO2010M08	8	13.1	25	14	10
504246	KO2010M10	10	14.3	25	17	10

## RS2010M/7-L25

Inhex Socket Set on Rail

## RS2010M/7-L100

## RS2010A/8-L25



Item Code	Part No.	Socket Sets	(g)
505545	KORS2010M/7-L25	RS2010M.25: 7 Piece Set/Rail 150mm 3, 4, 5, 6, 7, 8, 10mm	115
505544	KORS2010M/7-L100	RS2010M.100: 7 Piece Set/Rail 150mm 3, 4, 5, 6, 7, 8, 10mm	280
505543	KORS2010A/8-L25	RS2010A.25: 8 Piece Set/Rail 150mm 1/8, 5/32, 3/16, 7/32, 1/4, 9/32, 5/16, 3/8"	130

## RS2025/7-L28

TORX® Socket Set on Rail



Item Code	Part No.	Torx® Socket Sets	(g)
505547	KORS2025/7-L28	RS2025.28: 7 Piece Set/Rail 150mm T10, T15, T20, T25, T27, T30, T40	119

## RS2025/7-PR

PENTA-LOBE Socket Set on Rail



Item Code	Part No.	Torx® Socket Sets	(g)
505546	KORS2025/7(PR)	RS2025-28(PR): 7 Piece Set/Rail 150mm 10PR, 15PR, 20PR, 25PR, 27PR, 30PR, 40PR	119

Penta-Lobe (PR)													
PR	S (ref. mm)	8PR	9PR	10PR	15PR	20PR	25PR	27PR	30PR	40PR	45PR	50PR	55PR
		2.19	2.36	2.58	3.10	3.64	4.12	4.71	5.23	6.30	7.38	8.35	10.63

TORX® (T)																		
T	S (ref. mm)	T8	T9	T10	T15	T20	T25	T27	T30	T40	T45	T50	T55	T60	T70	T80	T90	T100
		2.30	2.48	2.72	3.26	3.84	4.40	4.96	5.49	6.60	7.77	8.79	11.17	13.20	15.49	17.51	19.88	22.09

# 1/4" Sockets & Accessories

**2753PS**

Reversible Ratchet Short



\* Renewal Kits → 2753RK

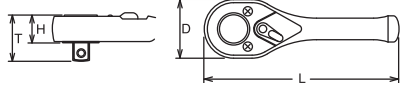

Item Code	Part No.	D (mm)	T (mm)	H (mm)	L (mm)	(g)	(pcs.)
504410	KO2753PS	22	18.7	11.4	75	55	5

**2753PB**

Reversible Ratchet with quick release button



\* Renewal Kits → 2753BRK



**2753JB**

Reversible Ratchet with quick release button



\* Renewal Kits → 2753BRK

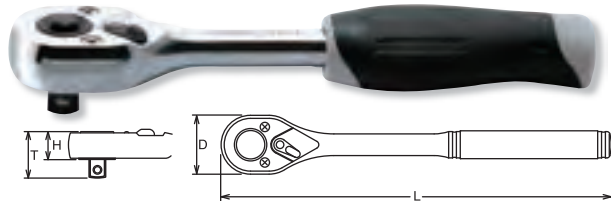

**2753N**

Reversible Ratchet



\* Renewal Kits → 2753RK



**2753P**

Reversible Ratchet



\* Renewal Kits → 2753RK



**2753J**

Reversible Ratchet



\* Renewal Kits → 2753RK

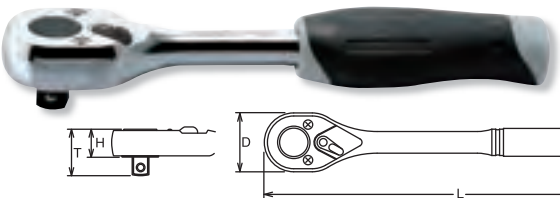

Item Code	Part No.	D (mm)	T (mm)	H (mm)	L (mm)	(g)	(pcs.)
504406	KO2753N	22	18.7	11.4	115	90	10
504407	KO2753P	22	18.7	11.4	115	87	10
504404	KO2753J	22	18.7	11.4	115	77	5

**2774P**

Flexible Ratchet, Reversible



\* Renewal Kits → 2753RK



**2774J**

Flexible Ratchet, Reversible



\* Renewal Kits → 2753RK

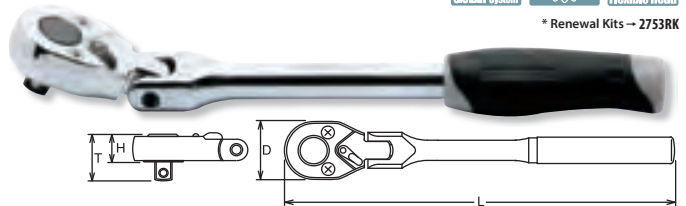

**2753P-160**

Reversible Ratchet Long



\* Renewal Kits → 2753RK

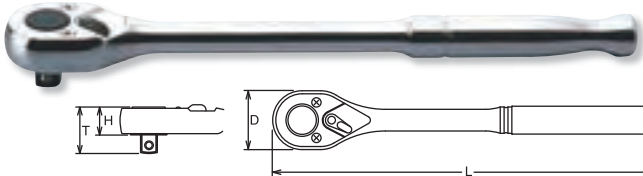

Item Code	Part No.	D (mm)	T (mm)	H (mm)	L (mm)	(g)	(pcs.)
504408	KO2753P-160	22	18.7	11.4	160	107	5

Item Code	Part No.	D (mm)	T (mm)	H (mm)	L (mm)	(g)	(pcs.)
504439	KO2774P	22	18.7	11.4	161	126	2
504436	KO2774J	22	18.7	11.4	161	130	2

**Kokem**

# 1/4" Sockets & Accessories

## Renewal Kits

### 2749RK



### 2753RK

2753N, 2753PS, 2753P, 2753P-160, 2753J, 2774PS, 2774JS, 2774N, 2774P, 2774J



Item Code	Part No.		(g)	(pce.)
504401	KO2749RK		30	1
504411	KO2753RK		30	1

### 2755 Ratchet Adaptor

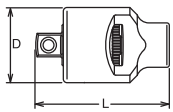

**44**

\* Renewal Kits → 2755RK

Item Code	Part No.	D (mm)	L (mm)	(g)	(pcs.)
504412	KO2755	26	40	80	10

### 2756 Quick Spinner

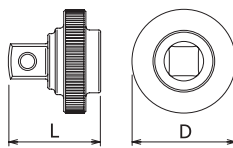

Item Code	Part No.	D (mm)	L (mm)	(g)	(pcs.)
504414	KO2756	22	20	19	10

### 2762 Flexible Extension Bar

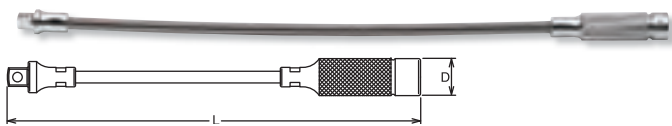

Item Code	Part No.	D (mm)	L (mm)	(g)	(pcs.)
504422	KO2762	13	300	90	2

### 2760 Extension Bars

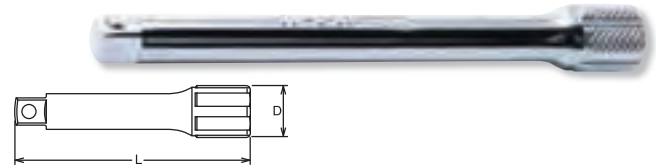

Item Code	Part No.	2760	D (mm)	L (mm)	(g)	(pcs.)
504415	KO2760050	50	12.3	50	23	10
504416	KO2760100	100	12.3	100	44	10
504417	KO2760150	150	12.3	150	63	10
504418	KO2760250	250	12.3	250	103	10
504420	KO2760400	400	12.3	400	160	2
504421	KO2760600	600	12.3	600	240	2

### PK2760/6 Extension Bar Set



#### PLASTIC TRAY

Item Code	Part No.	Extension Bars	(g)
505534	KOPK2760/6	6 Piece Set 2760 Extension Bars 28, 50, 100, 150, 200, 250	430

### 2763 Wobble-Fix Extension Bars

**Wobble-Fix Extension Bar**  
Two way usage : One for as a flexible extension bar to provide at 15° angle operation, the other for use as a normal extension bar.  
This 2-way usage is Patented.

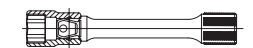

**⚠** The Wobble-Fix Extension Bar has less strength than normal extension bar due to its specific design with a reduced square drive. Make sure to use it correctly.

Item Code	Part No.	2763	D (mm)	L (mm)	(g)	(pcs.)
504423	KO2763028	28	12.3	28	14	10
504424	KO2763050	50	12.3	50	23	10
504425	KO2763075	75	12.3	75	33	10
504426	KO2763100	100	12.3	100	43	10

### PK2763/6 Wobble Extension Set



#### PLASTIC TRAY

Item Code	Part No.	Extension Bars	(g)
505535	KOPK2763/6	6 Piece Set 2763 Wobble-Fix Extension Bar 28, 50, 100, 150, 200, 250	420

# 1/4" Sockets & Accessories

**2768** Hinge Handle

\* Renewal Kits → 2768RK

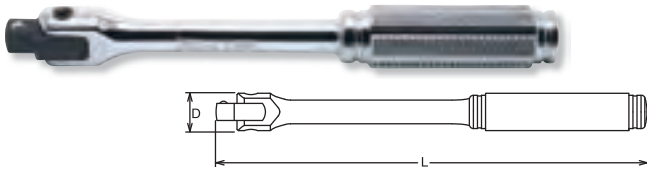

**2768P** Hinge Handle

\* Renewal Kits → 2768RK

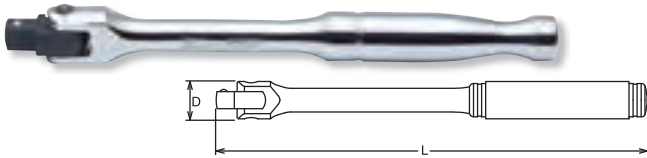

Item Code	Part No.	D (mm)	L (mm)	(g)	(pcs.)
504427	KO2768	14	130	86	10
504428	KO2768P	14	130	70	10

**2780** Speed Handle

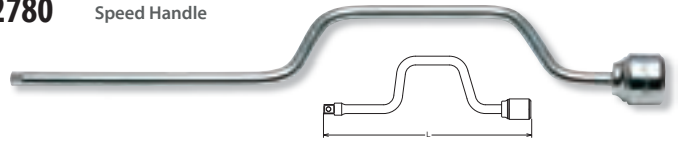

Item Code	Part No.	L (mm)	(g)	(pcs.)
504440	KO2780	350	250	1

**2785** T-Handle

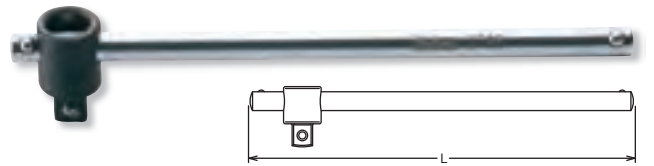

Item Code	Part No.	L (mm)	(g)	(pcs.)
504441	KO2785	115	36	10

**2769N-150** Spin Type Handle

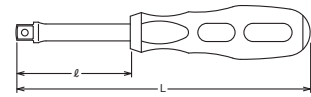

Item Code	Part No.	l (mm)	L (mm)	(g)	(pcs.)
504430	KO2769N150	50	150	68	2

⚠ Plastic or rubber handles are not intended to act as insulation.

**2233A** Adaptor

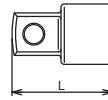

Item Code	Part No.	(sq.)	(sq.)	L (mm)	(g)	(pcs.)
504250	KO2233A	1/4"	3/8"	22	16	10

**2769F** Spin Type Handle

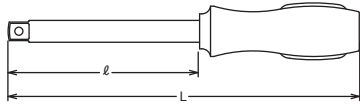

Item Code	Part No.	l (mm)	L (mm)	(g)	(pcs.)
504429	KO2769F	78	150	90	5

**2715** T-Handle

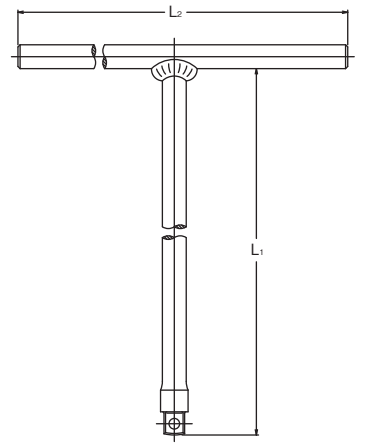

Item Code	Part No.	(sq.)	L1 (mm)	L2 (mm)	(g)	(pcs.)
504393	KO2715	1/4"	200	120	130	1

**2770** Universal Joint

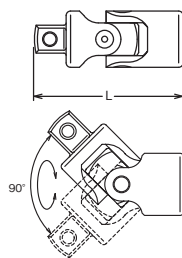

Item Code	Part No.	L (mm)	(g)	(pcs.)
504433	KO2770	33	20	10

**2137** Bit Holder

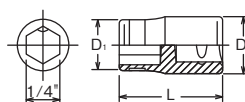

Item Code	Part No.	(sq.)	D1 (mm)	D2 (mm)	L (mm)	(g)	(pcs.)
504247	KO2137	1/4"	12	12	22.5	13	10

# 1/4" Sockets & Accessories

## 110 Adaptors

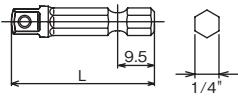

Item Code	Part No.	110	TYPE	L (mm)	(g)	(pcs.)
503647	KO110050	50B	Ball	50	15	10
503648	KO110100	100B	Ball	100	34	10
503649	KO110150	150B	Ball	150	54	10

## 2251A Socket Set



15 Piece Set  
METAL CASE:W160xH100xT28mm (g) = 690

Item Code	Part No.	Sockets	Accessories
504253	KO2251A	 2400A 6-pt. Sockets 3/16, 7/32, 1/4, 9/32, 5/16, 11/32, 3/8, 7/16, 1/2	2749N
			2760-50
			2760-150
			2768N
			2770
			2785

## 2201AM Socket Set



25 Piece Set  
METAL CASE:W240xH100xT32mm (g) = 870

Item Code	Part No.	Sockets	Accessories
504248	KO2201M	 2400M 6-pt. Sockets 4, 5, 5.5, 6, 7, 8, 9, 10, 11, 12, 13	2753N 2760-100 2769N-150 2770 2785
		 2400A 6-pt. Sockets 3/16, 7/32, 1/4, 9/32, 5/16, 11/32, 3/8, 7/16, 1/2	

## 2257M Socket Set



31 Piece Set  
METAL CASE:W240xH100xT32mm (g) = 930

Item Code	Part No.	Sockets	Accessories
504255^	KO2257M	 2400M 6-pt. Sockets 4, 4.5, 5, 5.5, 6, 7, 8, 9, 10, 11, 12	2753N 2760-100 2769N-150 2770 2785
		 2000.28 Bit Sockets 1, 2, 3, 4	
		 2005.25 Bit Sockets 4, 5, 6, 8, 9	
		 2010M.25 Bit Sockets 3, 4, 5, 6, 8, 10	

## 2201AW Sockets Set



23 Piece Set  
METAL CASE:W240xH100xT32mm (g) = 870

Item Code	Part No.	Sockets	Accessories
504249	KO2201AW	 2400W 6-pt. Sockets 8BA, 7BA, 6BA, 5BA, 4BA, 3BA, 2BA, 1BA, 0BA	2753N 2760-100 2769N-150 2770 2785
		 2400A 6-pt. Sockets 3/16, 7/32, 1/4, 9/32, 5/16, 11/32, 3/8, 7/16, 1/2"	







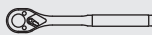

# 1/4" Sockets & Accessories

## 2260M

Socket Set

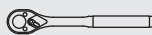

28 Piece Set  
METAL CASE: W370xH150xT50mm (g) = 2,370







Item Code	Part No.	Sockets	Accessories
504256	KO2260M	 2400M 6-pt. Sockets 4, 5, 5.5, 6, 7, 8, 10, 12	 2753N  2760-50  2760-100  2769N-150
		 3400M 6-pt. Sockets 8, 10, 11, 12, 13, 14, 15, 17, 18, 19, 21	 3749N  3760-75  3760-125  3785  3322A

## 2276

Sockets Set with Bits and Accessories



19 Piece Set  
METAL CASE: W192xH122xT30mm (g) = 640





Item Code	Part No.	Sockets	Accessories
504264	KO2276	 108P Phillips Bits 1, 2, 3	 2753PS  2769N-150  2137
		 108S Slotted Bits 4, 5, 6	
		 108H Hex Bits 3, 4, 5, 6	
		 108T TORX® Bits T10, T15, T20, T25, T27, T30	

## 2261M

Socket Set

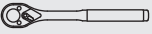

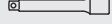
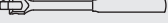
17 Piece Set  
METAL CASE: W192xH122xT30mm (g) = 690

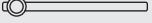
Item Code	Part No.	Sockets	Accessories
504257	KO2261M	 2400M 6-pt. Sockets 4, 4.5, 5, 5.5, 6, 7, 8, 9, 10, 11, 12	 2753N  2760-50  2760-150  2768N  2770  2785

## 2277

Sockets Set



21 Piece Set  
METAL CASE: W310xH86xT50mm (g) = 1,240

Item Code	Part No.	Sockets	Accessories
504265	KO2277	 2400M 6-pt. Sockets 5.5, 6, 7, 8, 9, 10, 11, 12, 13	 2753N  2763-75  2769N-150
		 2300M 6-pt. Deep Sockets 5.5, 6, 7, 8, 9, 10, 11, 12, 13	



# 3/8" Sockets & Accessories

## 3400M 3400A

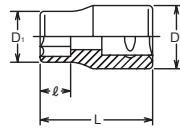
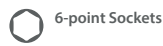

Item Code	Part No.	3400M (mm)	D <sub>1</sub> (mm)	D <sub>2</sub> (mm)	l (mm)	L (mm)	(g)	(pcs.)
504653	KO3400M06	6	9.9	17.3	6	26	20	10
504654	KO3400M07	7	10.8	17.3	6.5	26	20	10
504655	KO3400M08	8	12	17.3	7	26	22	10
504656	KO3400M09	9	13.3	17.3	7.5	26	23	10
504657	KO3400M10	10	14.5	17.3	8	26	24	10
504658	KO3400M11	11	15.8	17.3	8.5	26	25	10
504659	KO3400M12	12	16.8	17.3	9	26	25	10
504660	KO3400M13	13	18	17	9.5	26	24	10
504661	KO3400M14	14	19.5	18.5	11	27	31	10
504662	KO3400M15	15	20.8	19.5	11.5	28	39	10
504663	KO3400M16	16	22	20	12	28	42	10
504664	KO3400M17	17	23.3	21.5	12.5	29	51	10
504665	KO3400M18	18	24.5	22.5	13	30	51	10
504666	KO3400M19	19	25.8	23.5	13.5	30	63	10
504667	KO3400M20	20	27	24.5	14	31	75	10
504668	KO3400M21	21	28	26	14.5	32	77	10
504669	KO3400M22	22	29.5	26.5	15	32	82	10
504670	KO3400M23	23	30.8	27.5	15.5	33	95	10
504671	KO3400M24	24	32	28.5	16	34	102	10

Item Code	Part No.	3400A (inch)	D <sub>1</sub> (mm)	D <sub>2</sub> (mm)	l (mm)	L (mm)	(g)	(pcs.)
504639	KO3400A08	1/4	10.3	17.3	6	26	20	10
504640	KO3400A10	5/16	12	17.3	7	26	22	10
504641	KO3400A11	11/32	13.3	17.3	7.5	26	23	10
504642	KO3400A12	3/8	13.9	17.3	8	26	23	10
504643	KO3400A14	7/16	15.8	17.3	8.5	26	25	10
504644	KO3400A16	1/2	18	17	9.5	26	24	10
504645	KO3400A18	9/16	19.5	18.5	11	27	31	10
504646	KO3400A19	19/32	20.8	19.5	11.5	28	39	10
504647	KO3400A20	5/8	22	20	12	28	42	10
504648	KO3400A22	11/16	24.5	22.5	13	30	51	10
504649	KO3400A24	3/4	25.8	23.5	13.5	30	63	10
504650	KO3400A25	25/32	27	24.5	14	31	75	10
504651	KO3400A26	13/16	28	26	14.5	32	77	10
504652	KO3400A28	7/8	29.5	26.5	15	32	82	10

## 3405M 3405A

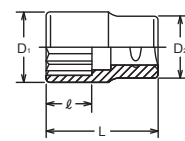
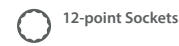

Item Code	Part No.	3405M (mm)	D <sub>1</sub> (mm)	D <sub>2</sub> (mm)	l (mm)	L (mm)	(g)	(pcs.)
504686	KO3405M06	6	9.9	17.3	6	26	20	10
504687	KO3405M07	7	10.8	17.3	6.5	26	20	10
504688	KO3405M08	8	12	17.3	7	26	22	10
504689	KO3405M09	9	13.3	17.3	7.5	26	23	10
504690	KO3405M10	10	14.5	17.3	8	26	24	10
504691	KO3405M11	11	15.8	17.3	8.5	26	25	10
504692	KO3405M12	12	16.8	17.3	9	26	25	10
504693	KO3405M13	13	18	17	9.5	26	24	10
504694	KO3405M14	14	19.5	18.5	11	27	31	10
504695	KO3405M15	15	20.8	19.5	11.5	28	39	10
504696	KO3405M16	16	22	20	12	28	42	10
504697	KO3405M17	17	23.3	21.5	12.5	29	51	10
504698	KO3405M18	18	24.5	22.5	13	30	51	10
504699	KO3405M19	19	25.8	23.5	13.5	30	63	10
504700	KO3405M20	20	27	24.5	14	31	75	10
504701	KO3405M21	21	28	26	14.5	32	77	10
504702	KO3405M22	22	29.5	26.5	15	32	82	10
504703	KO3405M23	23	30.8	27.5	15.5	33	95	10
504704	KO3405M24	24	32	28.5	16	34	102	10

Item Code	Part No.	3405A (inch)	D <sub>1</sub> (mm)	D <sub>2</sub> (mm)	l (mm)	L (mm)	(g)	(pcs.)
504672	KO3405A08	1/4	10.3	17.3	6	26	20	10
504673	KO3405A10	5/16	12	17.3	7	26	22	10
504674	KO3405A11	11/32	13.3	17.3	7.5	26	23	10
504675	KO3405A12	3/8	13.9	17.3	8	26	23	10
504676	KO3405A14	7/16	15.8	17.3	8.5	26	25	10
504677	KO3405A16	1/2	18	17	9.5	26	24	10
504678	KO3405A18	9/16	19.5	18.5	11	27	31	10
504679	KO3405A19	19/32	20.8	19.5	11.5	28	39	10
504680	KO3405A20	5/8	22	20	12	28	42	10
504681	KO3405A22	11/16	24.5	22.5	13	30	51	10
504682	KO3405A24	3/4	25.8	23.5	13.5	30	63	10
504683	KO3405A25	25/32	27	24.5	14	31	75	10
504684	KO3405A26	13/16	28	26	14.5	32	77	10
504685	KO3405A28	7/8	29.5	26.5	15	32	82	10

## RS3400M/12 RS3405M/12



Item Code	Part No.	Socket Sets	(g)
505582	KORS3400M/12	RS3400M: 12 Pieces Set (6 Point) Rail 300mm 8, 9, 10, 11, 12, 13, 14, 15, 16, 17, 18, 19mm	465
505586	KORS3405M/12	RS3400M: 12 Pieces Set (12 Point) Rail 300mm 8, 9, 10, 11, 12, 13, 14, 15, 16, 17, 18, 19mm	465

## RS3400A/9 RS3405A/9



Item Code	Part No.	Socket Sets	(g)
505581	KORS3400A/9	RS3400A: 9 Pieces Set/Rail 200mm 1/4, 5/16, 3/8, 7/16, 1/2, 9/16, 5/8, 11/16, 3/4"	333
505585	KORS3405A/9	RS3405A: 9 Pieces Set/Rail 200mm 1/4, 5/16, 3/8, 7/16, 1/2, 9/16, 5/8, 11/16, 3/4"	333

# 3/8" Sockets & Accessories

## 3405W

12-point Whitworth Sockets

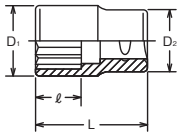

Item Code	Part No.	3405W (W)	D <sub>1</sub> (mm)	D <sub>2</sub> (mm)	ℓ (mm)	L (mm)	(g)	(pcs.)
504705	KO3405W04	1/8	13.3	17.3	7.5	26	22	10
504706	KO3405W06	3/16	15.8	17.3	8.5	26	25	10
504707	KO3405W08	1/4	18	17	9.5	26	24	10
504708	KO3405W10	5/16	20.8	19.5	11.5	28	39	10
504709	KO3405W12	3/8	24.5	22.5	13	30	51	10
504710	KO3405W14	7/16	28	26	14.5	32	81	10
504711	KO3405W16	1/2	30.8	27.5	15.5	33	103	10

## 3300M 3300A

6-point Deep Sockets

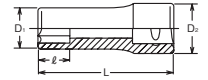

Item Code	Part No.	3300M (mm)	D <sub>1</sub> (mm)	D <sub>2</sub> (mm)	ℓ (mm)	L (mm)	(g)	(pcs.)
504577	KO3300M06	6	9.9	17.3	7	55	37	10
504578	KO3300M07	7	10.6	17.3	8	55	37	10
504579	KO3300M08	8	12	17.3	9	55	40	10
504581	KO3300M09	9	13	17.3	10	55	42	10
504582	KO3300M10	10	14.5	17.3	11	55	46	10
504584	KO3300M11	11	16	17.3	12	55	51	10
504585	KO3300M12	12	16.8	17.2	13	55	52	10
504587	KO3300M13	13	18	17	14	55	53	10
504588	KO3300M14	14	20	18	16	55	60	10
504590	KO3300M15	15	21	20	16	55	74	10
504591	KO3300M16	16	22	20	17	55	76	10
504592	KO3300M17	17	23.5	22	18	55	93	10
504593	KO3300M18	18	24.5	23	19	55	98	10
504594	KO3300M19	19	25	24	20	55	98	10
504595	KO3300M21	21	27	26	22	65	126	10
504596	KO3300M22	22	29	28	23	65	163	10
504597	KO3300M23	23	30	29	24	65	168	10
504598	KO3300M24	24	31	30	25	65	191	10

## 3425

TORX® Sockets

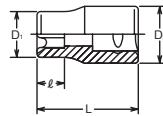

Item Code	Part No.	3425 (E)	D <sub>1</sub> (mm)	D <sub>2</sub> (mm)	ℓ (mm)	L (mm)	(g)	(pcs.)
504717	KO3425E4	E 4	5.6	17.3	4.6	26	18	10
504718	KO3425E5	E 5	7	17.3	5.2	26	20	10
504719	KO3425E6	E 6	8.3	17.3	5.4	26	21	10
504720	KO3425E7	E 7	8.9	17.3	6.6	26	22	10
504721	KO3425E8	E 8	9.9	17.3	7	26	23	10
504712	KO3425E10	E10	12	17.3	8.2	26	24	10
504713	KO3425E11	E11	13.3	17.3	8.7	26	25	10
504714	KO3425E12	E12	14.5	17.3	9.3	26	26	10
504715	KO3425E14	E14	15.8	17.3	10.6	26	27	10
504716	KO3425E16	E16	18	17	11.8	26	27	10

Item Code	Part No.	3300A (inch)	D <sub>1</sub> (mm)	D <sub>2</sub> (mm)	ℓ (mm)	L (mm)	(g)	(pcs.)
504560	KO3300A08	1/4	9.9	17.3	7	55	37	10
504561	KO3300A10	5/16	12	17.3	9	55	40	10
504562	KO3300A12	3/8	14	17.3	11	55	46	10
504563	KO3300A14	7/16	16	17.3	12	55	51	10
504564	KO3300A16	1/2	18	17	14	55	53	10
504565	KO3300A18	9/16	20	18	16	55	60	10
504566	KO3300A20	5/8	22	20	17	55	76	10
504567	KO3300A22	11/16	23.5	22	18	55	93	10
504568	KO3300A24	3/4	25	24	20	55	98	10
504569	KO3300A26	13/16	27	26	22	65	126	10
504570	KO3300A28	7/8	29	28	23	65	163	10

## RS3425/9

Socket Set on Rail



Item Code	Part No.	Torx Socket Set	(g)
505588	KORS3425/9	RS3425: 9 Pieces Set/Rail 200mm E4, E5, E6, E7, E8, E10, E12, E14, E16	239

## RS3300M/12

Socket Set on Rail

## RS3305M/12

Socket Set on Rail



Item Code	Part No.	Socket Sets	(g)
505573	KORS3300M/12	RS3300M: 12 Pieces Set/Rail 300mm 8, 9, 10, 11, 12, 13, 14, 15, 16, 17, 18, 19	878
505578	KORS3305M/12	RS3305M: 12 Pieces Set/Rail 300mm 8, 9, 10, 11, 12, 13, 14, 15, 16, 17, 18, 19	878

## RS3450M/8

Nut Grip® Socket Set on Rail



Item Code	Part No.	Nut Grip® Socket Set	(g)
505593	KO3450M/8	RS3450M: 8 Pieces Set/Rail 200mm 8, 10, 11, 12, 13, 14, 17, 19	310

## RS3300A/9

Socket Set on Rail

## RS3305A/9

Socket Set on Rail



Item Code	Part No.	Socket Sets	(g)
505571	KORS3300A/9	RS3300A: 9 Pieces Set/Rail 200mm 1/4, 5/16, 3/8, 7/16, 1/2, 9/16, 5/8, 11/16, 3/4"	628
505577	KORS3305A/9	RS3305A: 9 Pieces Set/Rail 200mm 1/4, 5/16, 3/8, 7/16, 1/2, 9/16, 5/8, 11/16, 3/4"	628

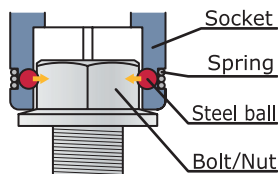

# 3/8" Sockets & Accessories

## 3305M 3305A

12-point Deep Sockets

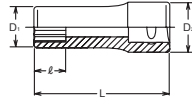

Item Code	Part No.	3305M (mm)	D <sub>1</sub> (mm)	D <sub>2</sub> (mm)	l (mm)	L (mm)	(g)	(pcs.)
504613	KO3305M06	6	9.9	17.3	7	55	37	10
504614	KO3305M07	7	10.6	17.3	8	55	37	10
504615	KO3305M08	8	12	17.3	9	55	40	10
504616	KO3305M09	9	13	17.3	10	55	42	10
504617	KO3305M10	10	14.5	17.3	11	55	46	10
504618	KO3305M11	11	16	17.3	12	55	51	10
504619	KO3305M12	12	16.8	17.2	13	55	52	10
504620	KO3305M13	13	18	17	14	55	53	10
504621	KO3305M14	14	20	18	16	55	60	10
504622	KO3305M15	15	21	20	16	55	74	10
504623	KO3305M16	16	22	20	17	55	76	10
504624	KO3305M17	17	23.5	22	18	55	93	10
504625	KO3305M18	18	24.5	23	19	55	98	10
504626	KO3305M19	19	25	24	20	55	98	10
504627	KO3305M21	21	27	26	22	65	126	10
504628	KO3305M22	22	29	28	23	65	163	10
504629	KO3305M23	23	30	29	24	65	168	10
504630	KO3305M24	24	31	30	25	65	191	10

Item Code	Part No.	3305A (inch)	D <sub>1</sub> (mm)	D <sub>2</sub> (mm)	l (mm)	L (mm)	(g)	(pcs.)
504602	KO3305A08	1/4	9.9	17.3	7	55	37	10
504603	KO3305A10	5/16	12	17.3	9	55	40	10
504604	KO3305A12	3/8	14	17.3	11	55	46	10
504605	KO3305A14	7/16	16	17.3	12	55	51	10
504606	KO3305A16	1/2	18	17	14	55	53	10
504607	KO3305A18	9/16	20	18	16	55	60	10
504608	KO3305A20	5/8	22	20	17	55	76	10
504609	KO3305A22	11/16	23.5	22	18	55	93	10
504610	KO3305A24	3/4	25	24	20	55	98	10
504611	KO3305A26	13/16	27	26	22	65	126	10
504612	KO3305A28	7/8	29	28	23	65	163	10

## 3215A

Socket Sets



PLASTIC BAG

Item Code	Part No.	7 Piece Socket Sets	(g)
504542	KO3215A	3305A 12-pt. Deep Sockets 5/16, 3/8, 7/16, 1/2, 9/16, 5/8, 11/16"	430

## 3300M (L120)

6-point Extra Deep Sockets



3300M-Size(L120) EXTRA DEEP SOCKET

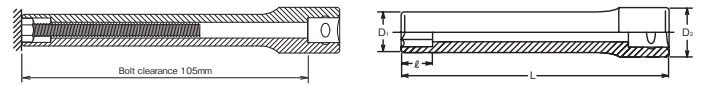

Item Code	Part No.	3300M (L120) (mm)	D <sub>1</sub> (mm)	D <sub>2</sub> (mm)	l (mm)	L (mm)	(g)	(pcs.)
504580	KO3300M08L120	8	12	17.3	9	120	85	10
504583	KO3300M10L120	10	14.5	17.3	11	120	110	10
504586	KO3300M12L120	12	16.8	17.2	13	120	116	10
504589	KO3300M14L120	14	20	18	16	120	166	5

## 3300M/4-L120

Socket Set



PLASTIC BAG

Item Code	Part No.	4 Piece Socket Set	(g)
504576	KO3300M/4-120	3300M(L120) 6-point Extra Deep Sockets 8, 10, 12, 142mm	477

## RS3300W/7

6 Point Whitworth Socket Set on Rail



Item Code	Part No.	Socket Sets	(g)
505574	KORS3300W/7	RS3300W: 7 Pieces Set/Rail 200mm 1/8, 3/16, 1/4, 5/16, 3/8, 7/16, 1/2"	719

## RS3325/9

Socket Set on Rail



Item Code	Part No.	Torx Deep Socket Set	(g)
505579	KORS3325/9	RS3325: 9 Pieces Set/Rail 200mm E4, E5, E6, E7, E8, E10, E12, E14, E16	420

# 3/8" Sockets & Accessories

## RS3350M/5 Nut Grip® Deep Socket Set on Rail



Item Code	Part No.	Nut Grip® Deep Socket Set	(g)
505580 <sup>^</sup>	KO3350M/5	3350M: 5 Pieces Set/Rail 150mm 8, 10, 12, 13, 14	322

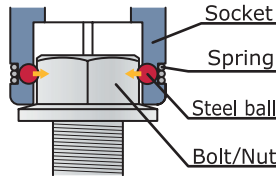
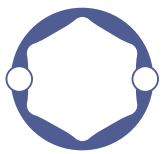

## RS3440M/8 Socket Set on Rail

### RS3440A /8



Item Code	Part No.	Universal Socket Sets	(g)
505591	KORS3440M/8	RS3440M: 8 Pieces Set/Rail 200mm 8, 10, 11, 12, 13, 14, 17, 19mm	550
505590	KORS3440A/8	RS3440A: 8 Pieces Set/Rail 200mm 5/16, 3/8, 7/16, 1/2, 9/16, 5/8, 11/16, 3/4"	570

## 3445M · 3445A 12-point Universal Sockets

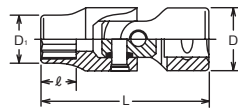

Item Code	Part No.	3445M (mm)	D <sub>1</sub> (mm)	D <sub>2</sub> (mm)	ℓ (mm)	L (mm)	(g)	(pcs.)
504736	KO3445M10	10	14.5	19	8.8	48.5	64	10
504737	KO3445M11	11	15.8	19	9.8	49.5	66	10
504738	KO3445M12	12	17	19	10.3	50	67	10
504739	KO3445M13	13	18.3	19	11.3	51	68	10
504740	KO3445M14	14	19.5	19	11.3	51	69	10
504741	KO3445M15	15	20.8	19	12.8	53.5	70	10
504742	KO3445M16	16	22	19	12.8	53.5	77	10
504743	KO3445M17	17	23.3	19	13.8	54.5	80	10
504744	KO3445M19	19	25.8	19	15.8	56.5	84	10

Item Code	Part No.	3445A (inch)	D <sub>1</sub> (mm)	D <sub>2</sub> (mm)	ℓ (mm)	L (mm)	(g)	(pcs.)
504732	KO3445A12	3/8	14	19	8.3	48	64	10
504733	KO3445A14	7/16	15.8	19	9.8	49.5	66	10
504734	KO3445A16	1/2	18.3	19	11.3	51	68	10
504735	KO3445A18	9/16	19.5	19	11.3	51	69	10

## 3010M-62 Inhex Bit Sockets

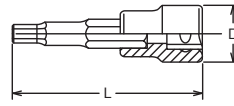

Item Code	Part No.	3010M.62 (mm)	D (mm)	L (mm)	(g)	(pcs.)
504456 <sup>^</sup>	KO3010M6203	3	18	62	43	10
504457 <sup>^</sup>	KO3010M6204	4	18	62	45	10
504458	KO3010M6205	5	18	62	48	10
504460 <sup>^</sup>	KO3010M6207	7	18	62	50	10
504461 <sup>^</sup>	KO3010M6208	8	18	62	62	10
504462 <sup>^</sup>	KO3010M6210	10	20	62	76	10
504463 <sup>^</sup>	KO3010M6212	12	20	62	94	10

## RS3010M/8-L38 Socket Set on Rail

### RS3010M/8-L62

### RS3010M/8-L100



Item Code	Part No.	Inhex Socket Sets	(g)
505560	KORS3010M/8-38	3010M.38: 8 Piece Set/Rail 200mm 3, 4, 5, 6, 7, 8, 10, 12mm	322
505561	KORS3010M/8-62	3010M.62: 8 Piece Set/Rail 200mm 3, 4, 5, 6, 7, 8, 10, 12mm	490
505562 <sup>^</sup>	KORS3010M8-L100	3010M.100: 8 Piece Set/Rail 200mm 3, 4, 5, 6, 7, 8, 10, 12mm	645

## 3025 (T) TORX® Bit Sockets

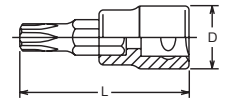

Item Code	Part No.	3025.38 (T)	D (mm)	L (mm)	(g)	(pcs.)
504496	KO3025-38T10	T10	18	38	32	10
504497	KO3025-38T15	T15	18	38	33	10
504498	KO3025-38T20	T20	18	38	33	10
504499	KO3025-38T25	T25	18	38	33	10
504500	KO3025-38T27	T27	18	38	33	10
504501	KO3025-38T30	T30	18	38	33	10
504502	KO3025-38T40	T40	18	38	34	10
504503	KO3025-38T45	T45	18	38	37	10

Item Code	Part No.	3025.50 (T)	D (mm)	L (mm)	(g)	(pcs.)
504513	KO3025T10	T10	18	50	36	10
504514	KO3025T15	T15	18	50	36	10
504515	KO3025T20	T20	18	50	36	10
504516	KO3025T25	T25	18	50	37	10
504517	KO3025T27	T27	18	50	37	10
504518	KO3025T30	T30	18	50	38	10
504519	KO3025T40	T40	18	50	39	10
504520	KO3025T45	T45	18	50	41	10
504521	KO3025T50	T50	20	50	55	10
504522	KO3025T55	T55	20	50	67	10

# 3/8" Sockets & Accessories

## RS3025/8-L50 TORX® Socket Set on Rail



Item Code	Part No.	TORX® Socket Set	(g)
505565	KORS3025/8	3025(T).50: 8 Piece Set/Rail 200mm T10, T15, T20, T25, T27, T30, T40, T45	320

## RS3025/9-PR PENTA-LOBE Socket Set on Rail



Item Code	Part No.	Penta-Lobe Bit Socket Set	(g)
505567	KORS3025/9(PR)	3025 (PR): 9 Piece Set/Rail 200mm 10PR, 15PR, 20PR, 25PR, 27PR, 30PR, 40PR, 45PR, 50PR	395

## RS3025/8-L100R Long TORX® Socket Set on Rail



Item Code	Part No.	Inhex Socket Sets	(g)
505566 <sup>^</sup>	KORS3025/8-L100R	3025-100R (T): 8 Piece Set/Rail 200mm T20, T25, T27, T30, T40, T45, T50, T55	490

## 3012M Inhex Sockets, Non-impact

### 3012A

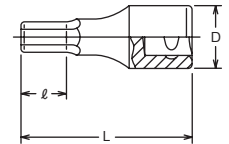

Item Code	Part No.	3012M.52 (mm)	D (mm)	ℓ (mm)	L (mm)	(g)	(pcs.)
504479	KO3012M5203	3	18	10	52	35	10
504480	KO3012M5204	4	18	15.5	52	38	10
504481	KO3012M5205	5	18	15.5	52	40	10
504482	KO3012M5206	6	18	15.5	52	42	10
504483	KO3012M5207	7	18	15.5	52	46	10
504484	KO3012M5208	8	18.5	15.5	52	50	10
504485	KO3012M5209	9	18.5	15.5	52	55	10
504486	KO3012M5210	10	20	15.5	52	66	10
504487	KO3012M5211	11	20	15.5	52	72	10
504488	KO3012M5212	12	20	15.5	52	77	10
504489	KO3012M5213	13	20	15.5	52	82	10
504490	KO3012M5214	14	20	15.5	52	89	10

3012M/A are for hand use only. Do not use with a power or impact wrench.

## 3025 (TH) Tamper-Resistant TORX® Bit Sockets

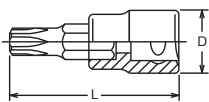

Item Code	Part No.	3025.50 (TH)	D (mm)	L (mm)	(g)	(pcs.)
504504	KO3025-50TH10	T10H	18	50	37	10
504505	KO3025-50TH15	T15H	18	50	38	10
504506	KO3025-50TH20	T20H	18	50	38	10
504507	KO3025-50TH25	T25H	18	50	38	10
504508	KO3025-50TH27	T27H	18	50	38	10
504509	KO3025-50TH30	T30H	18	50	39	10
504510	KO3025-50TH40	T40H	18	50	40	10
504511	KO3025-50TH45	T45H	18	50	41	10
504512	KO3025-50TH50	T50H	20	50	61	10

Tamper Resistant TORX® Bit Sockets have less strength due to special design. Make sure to use it correctly.

## RS3025/9-HOLE Tamper-Resistant TORX® Socket Set on Rail



Item Code	Part No.	Tamper Resistant TORX® Socket Set	(g)
505568	KORS3025/9TP	3025.50 (TH): 9 Piece Set/Rail 200mm T10H, T15H, T20H, T25H, T27H, T30H, T40H, T45H, T50H	405

Item Code	Part No.	3012A.52 (inch)	D (mm)	ℓ (mm)	L (mm)	(g)	(pcs.)
504467	KO3012A5204	1/8	18	10	52	35	10
504468	KO3012A5205	5/32	18	15.5	52	38	10
504469	KO3012A5206	3/16	18	15.5	52	40	10
504470	KO3012A5207	7/32	18	15.5	52	42	10
504471	KO3012A5208	1/4	18	15.5	52	44	10
504472	KO3012A5209	9/32	18	15.5	52	46	10
504473	KO3012A5210	5/16	18.5	15.5	52	50	10
504474	KO3012A5211	11/32	18.5	15.5	52	55	10
504475	KO3012A5212	3/8	20	15.5	52	65	10
504476	KO3012A5214	7/16	20	15.5	52	72	10
504477	KO3012A5216	1/2	20	15.5	52	82	10
504478	KO3012A5218	9/16	20	15.5	52	89	10

Item Code	Part No.	3012M.75 (mm)	D (mm)	ℓ (mm)	L (mm)	(g)	(pcs.)
504491	KO3012M7504	4	18	15.5	75	43	10
504492	KO3012M7505	5	18	15.5	75	48	10
504493	KO3012M7506	6	18	15.5	75	53	10
504494	KO3012M7508	8	18.5	15.5	75	72	10
504495	KO3012M7510	10	20	15.5	75	114	10

# 3/8" Sockets & Accessories

**RS3012M/8-L52**  
**RS3012A /8-L52**



**3752N**

Reversible Ratchet



\* Renewal Kits → 3752RK



Item Code	Part No.	D (mm)	T (mm)	H (mm)	L (mm)	(g)	(pcs.)
504755	KO3752N	33	34.3	23.9	200	310	1

Item Code	Part No.	Inhex Socket Sets	(g)
505564	KORS3012M52/8	3012M.52: 8 Piece Set/Rail 200mm 3, 4, 5, 6, 7, 8, 10, 12mm	394
505563	KORS3012A52/8	3012A.52: 8 Piece Set/Rail 200mm 1/8, 5/32, 3/16, 7/32, 1/4, 5/16, 3/8, 1/2"	425

**3012M/A** are for hand use only.  
Do not use with a power or impact wrench.



**[L/R Marking]**

A pointer and L/R markings on the ratchet head indicate the turning direction. The reduced diameter of the head allows easier access in tight spots.

**2749N-3/8**

Reversible Ratchet



\* Renewal Kits → 2749RK-3/8

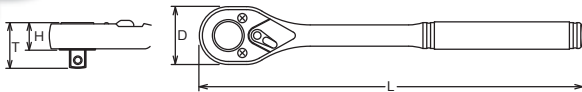

Item Code	Part No.	D (mm)	T (mm)	H (mm)	L (mm)	(g)	(pcs.)
504399	KO2749N-3/8	25	21.9	11.2	125	104	10

**2749-3/8** series have less strength compared with normal ratchet due to the technical design. Make sure to use the ratchet correctly.

**3776N**

Swivel Head Ratchet



\* Renewal Kits → 3752RK



**3776P**

Swivel Head Ratchet



\* Renewal Kits → 3752RK



**3776J**

Swivel Head Ratchet



\* Renewal Kits → 3752RK

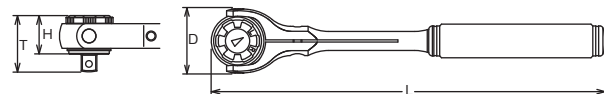

Item Code	Part No.	D (mm)	T (mm)	H (mm)	L (mm)	(g)	(pcs.)
504807	KO3776N	44	34.3	23.9	280	565	1
504808	KO3776P	44	34.3	23.9	280	560	1
504806	KO3776J	44	34.3	23.9	280	510	1

**3749S**

Reversible Ratchet Short



\* Renewal Kits → 3749RK



Item Code	Part No.	D (mm)	T (mm)	H (mm)	L (mm)	(g)	(pcs.)
504751	KO3749S	34	24.8	14.1	110	183	5

**3753SM**

Multi Purpose Ratchet, Reversible



\* Renewal Kits → 3753RK



Item Code	Part No.	D (mm)	T (mm)	H (mm)	L (mm)	(g)	(pcs.)
504764	KO3753SM	30.5	26.4	15.7	81	175	5

**3749N**

Reversible Ratchet



\* Renewal Kits → 3749RK

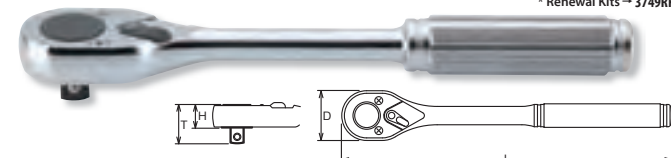

Item Code	Part No.	D (mm)	T (mm)	H (mm)	L (mm)	(g)	(pcs.)
504748	KO3749N	34	24.8	14.1	200	340	1

# 3/8" Sockets & Accessories

**3753N**

Reversible Ratchet



\* Renewal Kits → 3753RK



**3753P**

Reversible Ratchet



\* Renewal Kits → 3753RK



Item Code	Part No.	D (mm)	T (mm)	H (mm)	L (mm)	(g)	(pcs.)
504758	KO3753N	30.5	26.4	15.7	200	320	1
504760	KO3753P	30.5	26.4	15.7	200	286	1

**3753P-250**

Reversible Ratchet Long



\* Renewal Kits → 3753RK

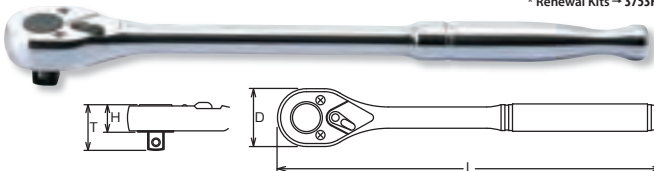

Item Code	Part No.	D (mm)	T (mm)	H (mm)	L (mm)	(g)	(pcs.)
504761	KO3753P-250	30.5	26.4	15.7	250	335	1

**2774JS-3/8**

Flexible Ratchet, Reversible



\* Renewal Kits → 2749RK-3/8

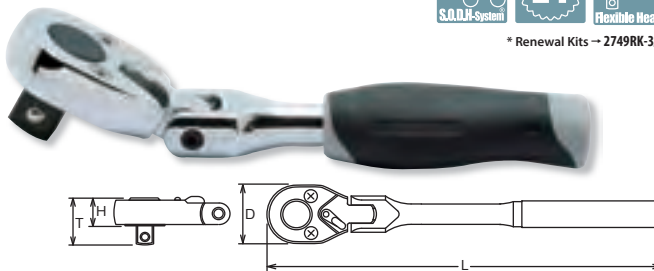

Item Code	Part No.	D (mm)	T (mm)	H (mm)	L (mm)	(g)	(pcs.)
504438	KO2774JS-3/8	25	21.9	11.2	120	113	5

**⚠** 2774-3/8 series have less strength compared with normal ratchet due to the technical design. Make sure to use the ratchet correctly.

**3774PS**

Flexible Ratchet, Reversible



\* Renewal Kits → 3753RK

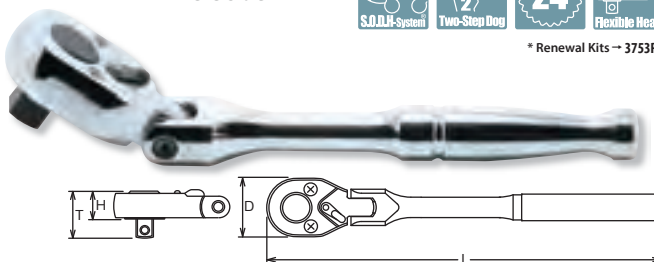

Item Code	Part No.	D (mm)	T (mm)	H (mm)	L (mm)	(g)	(pcs.)
504802	KO3774PS	30.5	26.4	15.7	175	250	2

**3774N**

Flexible Ratchet, Reversible



\* Renewal Kits → 3753RK



**3774P**

Flexible Ratchet, Reversible



\* Renewal Kits → 3753RK



**3774J**

Flexible Ratchet, Reversible



\* Renewal Kits → 3753RK

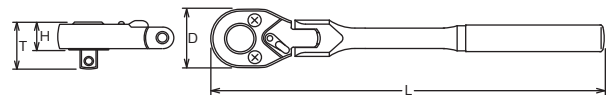

Item Code	Part No.	D (mm)	T (mm)	H (mm)	L (mm)	(g)	(pcs.)
504798	KO3774N	30.5	26.4	15.7	265	378	2
504800	KO3774P	30.5	26.4	15.7	265	378	2
504797	KO3774J	30.5	26.4	15.7	285	367	1

**3774PB**



Flexible Ratchet, reversible with quick release button



\* Renewal Kits → 3753RK

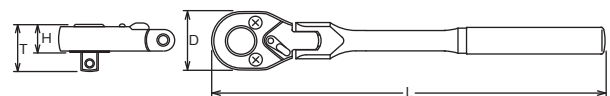

Item Code	Part No.	D (mm)	T (mm)	H (mm)	L (mm)	(g)	(pcs.)
504801	KO3774PB	30.5	26.4	15.7	265	373	2

**⚠** Reversible Ratchet with quick release button has less strength compared with normal ratchet due to the technical design. Make sure to use the ratchet correctly.



**Reversible Ratchet with Quick Release Button :**  
Sockets and accessories are safely locked.  
By pushing the button the sockets or extension bars are released from the ratchet.

**Korpen**

# 3/8" Sockets & Accessories

## 3774NL Flex-Head Ratchet with Head Lock Button



\* Renewal Kits → 3753RK



Item Code	Part No.	D (mm)	T (mm)	H (mm)	L (mm)	(g)	(pcs.)
504799 <sup>^</sup>	KO3774NL	30.5	26.4	15.7	265	378	2

⚠ Reversible Ratchet with quick release button has less strength compared with normal ratchet due to the technical design. Make sure to use the ratchet correctly.

## 3775 Flex-Head Ratchet 44 GEARS



Item Code	Part No.	D (mm)	T (mm)	H (mm)	L (mm)	(g)	(pcs.)
504804	KO3775	36	28.6	15.7	250	374	2

## 3756 Quick Spinner



Item Code	Part No.	D (mm)	L (mm)	(g)	(pcs.)
504767	KO3756	30.5	25.5	47	10

## 3757 Ratchet Wheel



\* Renewal Kits → 3752RK



Item Code	Part No.	D (mm)	L (mm)	(g)	(pcs.)
504768	KO3757	50	35	155	5

## Renewal Kits

### 3752RK 3752N, 3752J, 3757, 3776N, 3776P, 3776J

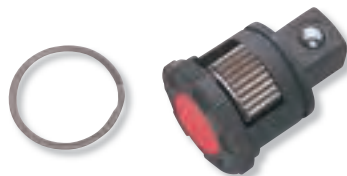

### 3753RK 3753SM, 3753N, 3753P, 3753P-250, 3753J, 3774PS, 3774D-SR, D3753J, 3774N, 3774P, 3774J, 3774NL, 3774PL, 3774JL



Item Code	Part No.	□	(g)	(pcs.)
504756	KO3752RK	3/8"	84	1
504762	KO3753RK		76	1

## 3762 Flexible Extension Bar

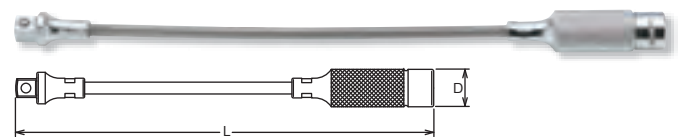

Item Code	Part No.	D (mm)	L (mm)	(g)	(pcs.)
504779	KO3762	19.3	300	178	2

## 3760 Extension Bars

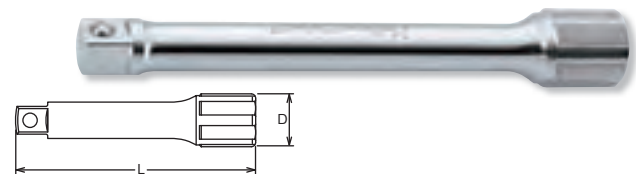

Item Code	Part No.	D (mm)	L (mm)	(g)	(pcs.)
504770	KO3760032	18	32	27	10
504771	KO3760050	18	50	47	10
504772	KO3760075	18	75	68	10
504774	KO3760125	18	125	106	10
511083	KO3760150	18	150	125	10
504775	KO3760250	18	250	196	5
504776	KO3760400	18	400	365	1
504777	KO3760600	18	600	538	1
504778	KO3760900	18	900	805	1
504773	KO37601000	18	1000	968	1

## 3755 Ratchet Adaptor



\* Renewal Kits → 3755RK



Item Code	Part No.	D (mm)	L (mm)	(g)	(pcs.)
504765	KO3755	30.5	55	146	5



# 3/8" Sockets & Accessories

## PK3760/6 Extension Bar Set



6 Piece Set  
PLASTIC TRAY

Item Code	Part No.	Extension Bars	(g)
505536	KOPK3760/6	3760 Extension Bars 32, 50, 75, 125, 150, 250	670

## 3763 Wobble-Fix Extension Bars

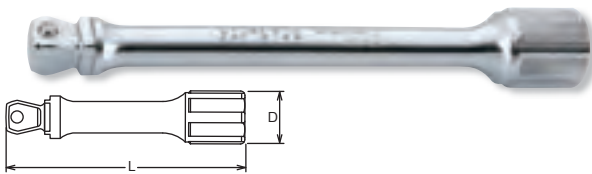

Item Code	Part No.	D (mm)	L (mm)	(g)	(pcs.)
504780	KO3763032	18	32	26	10
504781	KO3763050	18	50	42	10
504782	KO3763075	18	75	57	10
504783	KO3763125	18	125	80	10
504784	KO3763150	18	150	98	10
504785	KO3763250	18	250	144	5

The Wobble-Fix Extension Bar has less strength than normal extension bar due to its specific design with a reduced square drive. Make sure to use it correctly.

## PK3763/6 Wobble-Fix Extension Bar Set



6 Piece Set  
PLASTIC TRAY

Item Code	Part No.	Extension Bars	(g)
505537	KOPK3763/6	3763 Wobble-Fix Extension Bars 32, 50, 75, 125, 150, 250	560

### Wobble-Fix Extension Bar

Two way usage : one for as a flexible extension bar to provide at 15° angle operation, the other for use as a normal extension bar. This usage is Patented.

The Wobble-Fix Extension Bar has less strength than normal extension bar due to its specific design with a reduced square drive. Make sure to use it correctly.

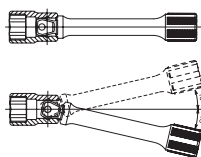

## 3768N-175 Hinge Handle



\* Renewal Kits → 3768RK

## 3768N-250 Hinge Handle



\* Renewal Kits → 3768RK

## 3768P-250 Hinge Handle



\* Renewal Kits → 3768RK

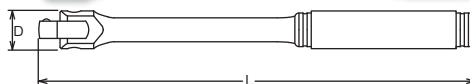

Item Code	Part No.	D (mm)	L (mm)	(g)	(pcs.)
504786	KO3768175	20.5	175	255	5
504787	KO3768250	20.5	250	290	5
504788	KO3768P250	20.5	250	275	5

## 3768P-380 Hinge Handle



\* Renewal Kits → 3768RK

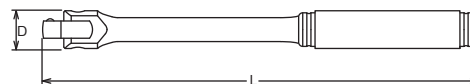

Item Code	Part No.	D (mm)	L (mm)	(g)	(pcs.)
504789	KO3768P380	20.5	380	435	2

KO3768P380 has a longer handle than standard, and can be loaded to excessive torque value. In the interest of your own safety always apply load evenly and progressively to avoid breakage and possible injury.

## 3769N-160 Spin Type Handle

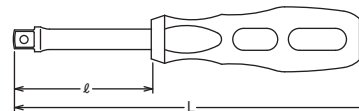

Item Code	Part No.	l (mm)	L (mm)	(g)	(pcs.)
504792	KO3769N-160	50	160	96	2

Plastic or rubber handles are not intended to act as insulation.

# 3/8" Sockets & Accessories

**3769H** Folding Socket Driver

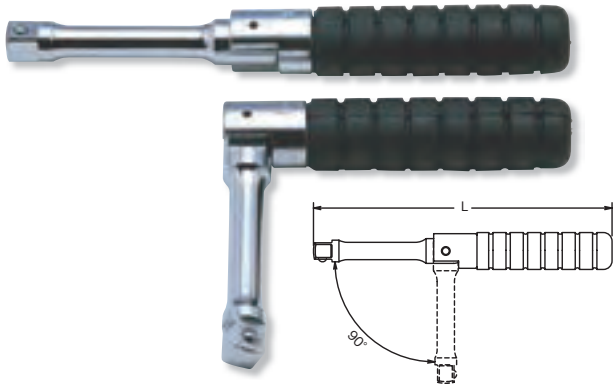

Item Code	Part No.	L (mm)	(g)	(pcs.)
504791	KO3769H	170	210	2

**3785** T-Handle

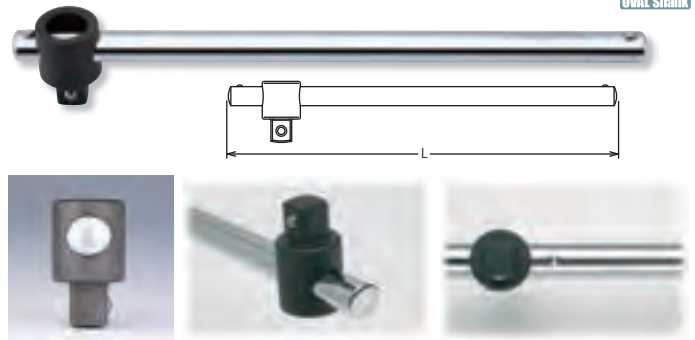

Innovative Oval shaped bar provides higher durability and stops the sliding square part turning around the bar.

Item Code	Part No.	L (mm)	(g)	(pcs.)
504811	KO3785	200	157	5

**3770** Universal Joint



**3771** Universal Joint



Item Code	Part No.	L (mm)	(g)	(pcs.)
504794	KO3770	50	66	10
504796	KO3771	43	46	10

**3322A** Adaptor Warranty 86Nm



Item Code	Part No.	D (mm)	(sq)	L (mm)	(g)	(pcs.)
504636	KO3322A	3/8"	1/4"	24	18	10

⚠ Adapting down from bigger square drive to smaller square drive may lead to excessive torque and possibly cause breakage.

**3344A** Adaptor



Item Code	Part No.	(sq)	(sq)	L (mm)	(g)	(pcs.)
504638	KO3344A	3/8"	1/2"	30	35	10

⚠ Adapting down from bigger square drive to smaller square drive may lead to excessive torque and possibly cause breakage.

**3780** Speed Handle

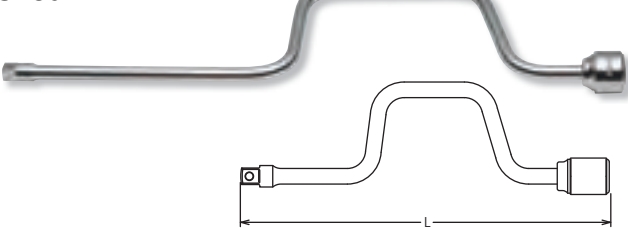

Item Code	Part No.	L (mm)	(g)	(pce.)
504809	KO3780	400	432	1

**PK2346/6** Adaptor Set



- 2233A (1/4" X 3/8")
- 3322A (3/8" X 1/4") Warranty 86Nm
- 3344A (3/8" X 1/2")
- 4433A (1/2" X 3/8") Warranty 290Nm
- 4466A (1/2" X 3/4")
- 6644A (3/4" X 1/2") Warranty 668Nm

PLASTIC TRAY		6 Piece Set/⚖=460g			
Item Code	Part No.	Adaptors			
505533	KOPK2346/6	1/4" ㊦→3/8" ㊦	2233A	3/8" ㊦→1/4" ㊦	3322A
		3/8" ㊦→1/2" ㊦	3344A	1/2" ㊦→3/8" ㊦	4433A-35
		1/2" ㊦→3/4" ㊦	4466A	3/4" ㊦→1/2" ㊦	6644A

# 3/8" Sockets & Accessories

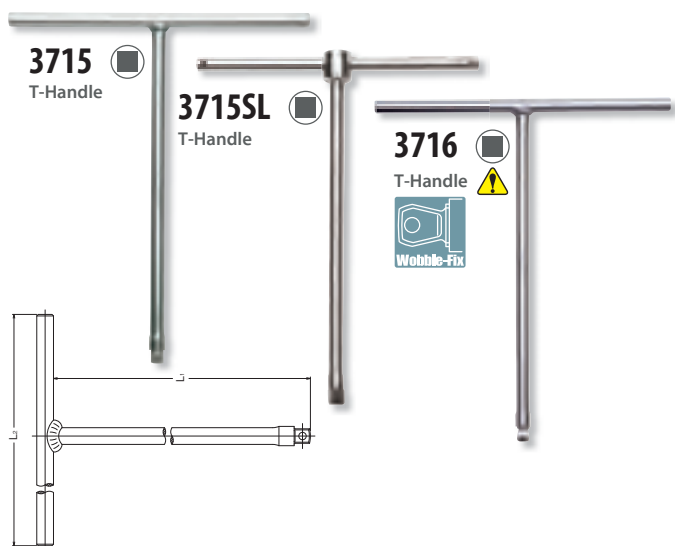

Item Code	Part No.	3/8"	L1 (mm)	L2 (mm)	(g)	(pcs.)
504745	KO3715		268	240	386	1
504746	KO3715SL	3/8"	237	200	325	1
504747	KO3716		268	240	379	1

⚠️ 3715/3716 This tool is used sockets in hard to reach places. 3716 has a reduced square drive and similar function as offset extension bars.

## 3127



### NUTTWISTER®

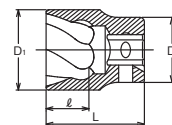

Item Code	Part No.	3127 (mm)	3/8"	D <sub>1</sub> (mm)	D <sub>2</sub> (mm)	l (mm)	L (mm)	(g)	(pcs.)
504523	KO3127M08	8		11.5	19	8	32	40	10
504524	KO3127M09	9		13	19	8	32	40	10
504525	KO3127M10	10		14.8	19	10	32	41	10
504526	KO3127M11	11		16	19	10	32	43	10
504527	KO3127M12	12		17	19	12	32	44	10
504528	KO3127M13	13	3/8"	18.5	19	12	32	46	10
504529	KO3127M14	14		19.7	19	14	32	48	10
504530	KO3127M15	15		20.7	19	14	32	52	10
504531	KO3127M16	16		22.2	22	14	32	66	10
504532	KO3127M17	17		23.5	22	16	35	80	10



⚠️ A very effective method and easy solution for removing rounded off nuts, bolts and studs. The sharp edges of the NUTTWISTER® Socket opening will tighten around the nut, bolt or stud and turn it easily off.

## 3137

### Bit Holder

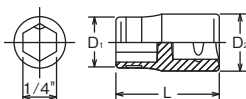

Item Code	Part No.	3/8"	D <sub>1</sub> (mm)	D <sub>2</sub> (mm)	L (mm)	(g)	(pcs.)
504533	KO3137	3/8"	13	16.5	30	30	10

## RS3129/6-L32

### BOLT TWISTER® Socket Set on Rail



## RS3129/6-L60

### BOLT TWISTER® Socket Set on Rail



## 112

### Adaptors

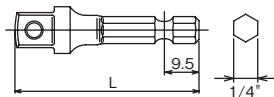

Item Code	Part No.	3/8"	TYPE	L (mm)	(g)	(pcs.)
503650	KO112050		Ball	50	21	10
503651	KO112100	3/8"	Ball	100	71	10

Item Code	Part No.	Socket Sets	(g)
505569	KORS3129/6-L32	RS3129-32: 6 Piece Set / Rail 150mm 2, 3, 4, 6, 8, 10	250
505570	KORS3129/6-L60	RS3129-60: 6 Piece Set / Rail 150mm 2, 3, 4, 6, 8, 10	320

BOLTTWISTER	Bolt size	Drill size
2	M5	Ø 2.4- 2.6
3	M6	Ø 3.2- 3.5
4	M8	Ø 4.2- 4.5
6	M10-M12	Ø 6.2- 6.5
8	M14-M16	Ø 8.2- 8.5
10	M18-M20	Ø10.2-10.5

Effective method and easy solution for removing twisted off bolt. Drill a hole in the center of bolt and drive BOLTTWISTER® firmly into the hole. The sharp spiral edges will hold the broken bolt and easily remove it.

# 3/8" Sockets & Accessories

## 3300C

Spark Plug Sockets with Spring Clips

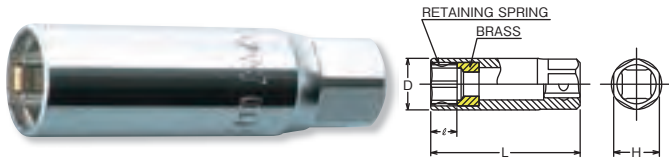

Item Code	Part No.	3300C (mm)	□	D (mm)	ℓ (mm)	L (mm)	H (mm)	(g)	(pcs.)
504572	KO3300C14	14	3/8"	19	11	70	17	82	10
504573	KO3300C16	16		20.5	13	70	17	91	10
504574	KO3300C18	18		23.9	12	70	21	140	10
504575	KO3300C20.8	20.8		26.9	13.5	70	22	132	10

## 3305P

Spark Plug Socket with Magnet, 12-pt. opening

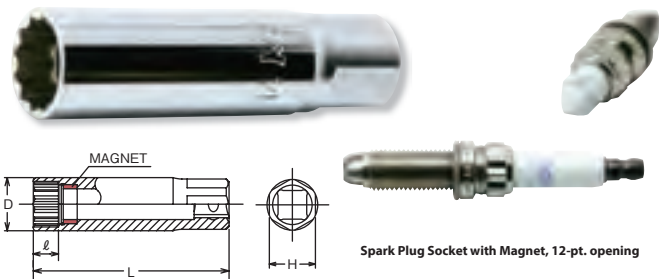

Item Code	Part No.	3305P (mm)	□	D (mm)	ℓ (mm)	L (mm)	H (mm)	(g)	(pcs.)
504631	KO3305P14	14	3/8"	19	8	70	17	87	10

## 3300S

Spark Plug Sockets with Rubber



Item Code	Part No.	3300S (mm)	□	D (mm)	ℓ (mm)	L (mm)	H (mm)	(g)	(pcs.)
504599	KO3300S16	16	3/8"	20.9	19	70	17	100	10
504600	KO3300S18	18		23.9	21	70	21	145	10
504601	KO3300S20.8	20.8		26.9	27	70	22	140	10

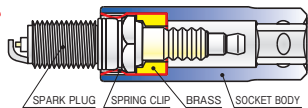

### SPARK PLUG SOCKETS with SPRING CLIP

This revolutionary new spark plug socket is designed to securely grip a spark plug at its hexagonal part by two stainless spring clips. The clips are held in place by an internal brass guide which ensures perfect alignment of the spark plug into the threaded plug hole of the cylinder head, thus preventing thread damage. The brass guide also eliminates stress loading and possible damage to the ceramic insulator of the spark plug.

## 3201AMW

Socket Set



42 Piece Set  
METAL CASE:W445xH190xT50mm

⚖ = 4,700g

Item Code	Part No.	Sockets	Accessories
504537	KO3201AMW	3405M 12-pt. Sockets 9, 10, 11, 12, 13, 14, 15, 16, 17, 18, 19, 20, 21, 22mm	3753N 3760-75 3760-125
		3405A 12-pt. Sockets 5/16, 3/8, 7/16, 1/2, 9/16, 5/8, 11/16, 3/4, 25/32, 13/16, 7/8"	3760-250 3768N-250 3769N-160 3770
		3405W 12-pt. Sockets 1/8, 3/16, 1/4, 5/16, 3/8, 7/16, 1/2"	3780 3785 3344A

## 3206M

Socket Set



21 Piece Set  
METAL CASE:W395xH90xT50mm

⚖ (g) = 2,100

Item Code	Part No.	Sockets	Accessories
504540	KO3206M	3400M 6-pt. Sockets 6, 7, 8, 9, 10, 11, 12	3753N 3760-125
		3405M 12-pt. Sockets 13, 14, 15, 16, 17, 18, 19, 21, 22	3760-250 3768N-250 3785

## 3229

Spark Plug Socket Set with Spring Clips



3 Piece Set  
METAL CASE

Item Code	Part No.	Sockets	⚖ (g)
504552	KO3229	3300C Spark Plug Sockets with Metal Spring Clips : 16, 18, 20.8mm	700

# 3/8" Sockets & Accessories

## 3206AM Socket Set



27 Piece Set  
METAL CASE:W445xH190xT50mm  $\Delta$  = 3,500g

Item Code	Part No.	Sockets	Accessories
504539	KO3206AM	<b>3405M</b> 12-pt. Sockets 7, 8, 10, 11, 12, 13, 14, 15, 16, 17, 19, 22mm	3753N 3760-125
		<b>3405A</b> 12-pt. Sockets 3/8, 7/16, 1/2, 9/16, 5/8, 11/16, 3/4, 13/16, 7/8"	3760-250 3768N-250
		<b>3300C</b> Spark Plug Socket 20.8mm	3770

## 3217M Socket Set

### 3217MS 3217A



METAL CASE

Item Code	Part No.	Sockets	(g)
504546	KO3217M	<b>3405M</b> 12-pt. Sockets 14 Piece Set 9, 10, 11, 12, 13, 14, 15, 16, 17, 18, 19, 20, 21, 22	850
504547	KO3217MS	<b>3405M</b> 6-pt. Sockets 14 Piece Set 9, 10, 11, 12, 13, 14, 15, 16, 17, 18, 19, 20, 21, 22	850
504545	KO3217A	<b>3405A</b> 6-pt. Sockets 13 Piece Set 5/16, 3/8, 7/16, 1/2, 9/16, 19/32, 5/8, 3/4, 25/32, 13/16, 7/8, 1 1/16	790

## 3210M Socket Set



22 Piece Set  
METAL CASE:W395xH90xT50mm  $\Delta$  (g) = 2,900

Item Code	Part No.	Sockets	Accessories
504541	KO3210M	<b>3400M</b> 6-pt. Sockets 6, 7, 8, 9, 10, 11, 12	3753N 3760-125 3760-250
		<b>3405M</b> 12-pt. Sockets 13, 14, 15, 16, 17, 18, 19, 21, 22	3768N-250 3770 3785

## 3220M Socket Set



14 Piece Set  
METAL CASE:W415xH120xT50mm  $\Delta$  (g) = 2,270

Item Code	Part No.	Sockets	Accessories
504548	KO3220M	<b>3405M</b> 12-pt. Sockets 8, 9, 10, 11, 12, 13, 14, 17, 19, 21, 22mm	3753N 3760-125 3768N-250

## 3225A Set for Torque Controlled Installation of Spark Plugs



**TORQUE RATCHET**  
The torque is set at 25Nm. When the torque is loaded higher than 25Nm, the gear slips and no increased torque is transmitted. Cylinder heads and spark plugs are protected by this mechanism.

4 Piece Set  
METAL CASE:W215xH80xT47mm

Item Code	Part No.	Sockets	Accessories	(g)
504551	KO3225A	<b>3300C</b> Spark Plug Sockets 16, 20.8	3751J-25 3763-125	960









**Koken**

# 3/8" Sockets & Accessories

**3275** Socket Set

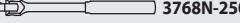





24 Piece Set  
METAL CASE:W400xH147xT50mm  $\Delta = 3,150g$

Item Code	Part No.	Sockets	Accessories
504556 <sup>^</sup>	KO3275	 <b>3400M</b> 6-pt. Sockets 6, 7, 8, 9, 10, 11, 12	 <b>3753N</b>  <b>3760-125</b>
		 <b>3405M</b> 12-pt. Sockets 13, 14, 15, 16, 17, 18, 19, 21, 22	 <b>3760-250</b>  <b>3768N-250</b>
		 <b>3300C</b> Spark Plug Sockets 16, 20.8	 <b>3770</b>  <b>3756</b>

**3276** Bit Socket Set

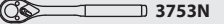







20 Piece Set  
METAL CASE:W310xH150xT50mm  $\Delta = 3,370g$

Item Code	Part No.	Sockets	Accessories
504557 <sup>^</sup>	KO3276	 <b>3000 Bit Sockets</b> 2, 3	 <b>3753N</b>  <b>3763-125</b>
		 <b>3005 Bit Sockets</b> 5, 8	
		 <b>3010M.62</b> Hex Bit Sockets 5, 6, 7, 8, 10	
		 <b>3025.50</b> TORX® Bit Sockets T10, T15, T20, T25, T27, T30, T40, T45, T50	

**3277** Socket Set

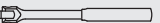

29 Piece Set  
METAL CASE:W370xH150xT50mm  $\Delta = 3,240g$

Item Code	Part No.	Sockets	Accessories
504558	KO3277	 <b>3400M</b> 6-pt. Sockets 8, 9, 10, 11, 12mm	 <b>3753N</b>  <b>3760-125</b>  <b>3768N-250</b>
		 <b>3405M</b> 12-pt. Sockets 13, 14, 15, 16, 17, 18, 19, 21mm	
		 <b>3300M</b> 6-pt. Deep Sockets 8, 9, 10, 11, 12mm	
		 <b>3305M</b> 12-pt. Deep Sockets 13, 14, 15, 16, 17, 18, 19, 21mm	

# 1/2" Sockets & Accessories

4400M · 4400A

6-Point Sockets

4405M · 4405A

12-Point Sockets

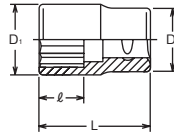

Item Code	Part No.	4400M (mm)	D <sub>1</sub> (mm)	D <sub>2</sub> (mm)	ℓ (mm)	L (mm)	(g)	(pcs.)
505095	KO4400M08	8	13.2	21	8	36	44	10
505096	KO4400M09	9	13.8	21	8.5	37	44	10
505097	KO4400M10	10	15.3	21	9	37	45	10
505098	KO4400M11	11	16.5	21	9.5	37	46	10
505099	KO4400M12	12	17.8	21	10	37	47	10
505100	KO4400M13	13	19	22	10.5	37	53	10
505101	KO4400M14	14	20.3	22	11	37	56	10
505102	KO4400M15	15	21.5	22	11.5	37	57	10
505103	KO4400M16	16	22.8	22	12	37	62	10
505104	KO4400M17	17	24	23	12.5	37	69	10
505105	KO4400M18	18	25	24	13	37	74	10
505106	KO4400M19	19	26.5	25	14	38	89	10
505107	KO4400M20	20	27.8	26	15	38	92	10
505108	KO4400M21	21	29	27	15.5	38	102	10
505109	KO4400M22	22	30	28	16	40	113	10
505110	KO4400M23	23	31.5	29	16.5	40	128	10
505111	KO4400M24	24	32.8	30	17	42	140	5
505112	KO4400M25	25	34	31	18	42	164	5
505113	KO4400M26	26	35	32	19	42	165	5
505114	KO4400M27	27	36.5	33	19.5	43	182	5
505115	KO4400M28	28	37.8	34	20	43	198	5
505116	KO4400M29	29	39	35	20.5	43	205	5
505117	KO4400M30	30	40	36	22	46	222	5
505118	KO4400M31	31	41.5	37	22.5	46	246	5
505119	KO4400M32	32	42.8	38	23	46	261	5
505120	KO4400M33	33	44.2	39	24	47	275	5
505121	KO4400M34	34	45.2	40	24	47	315	5
505122	KO4400M35	35	46.2	40	24	47	317	5
505123	KO4400M36	36	47.2	41	24	47	336	5

Item Code	Part No.	4400M (mm)	D <sub>1</sub> (mm)	D <sub>2</sub> (mm)	ℓ (mm)	L (mm)	(g)	(pcs.)
505148	KO4405M07	7	11.5	21	7	36	43	10
505149	KO4405M08	8	13.2	21	8	36	44	10
505150	KO4405M09	9	13.8	21	8.5	37	44	10
505151	KO4405M10	10	15.3	21	9	37	45	10
505152	KO4405M11	11	16.5	21	9.5	37	46	10
505153	KO4405M12	12	17.8	21	10	37	47	10
505154	KO4405M13	13	19	22	10.5	37	53	10
505155	KO4405M14	14	20.3	22	11	37	56	10
505156	KO4405M15	15	21.5	22	11.5	37	57	10
505157	KO4405M16	16	22.8	22	12	37	62	10
505158	KO4405M17	17	24	23	12.5	37	69	10
505159	KO4405M18	18	25	24	13	37	74	10
505160	KO4405M19	19	26.5	25	14	38	89	10
505161	KO4405M20	20	27.8	26	15	38	92	10
505162	KO4405M21	21	29	27	15.5	38	102	10
505163	KO4405M22	22	30	28	16	40	113	10
505164	KO4405M23	23	31.5	29	16.5	40	128	10
505165	KO4405M24	24	32.8	30	17	42	140	5
505166	KO4405M25	25	34	31	18	42	164	5
505167	KO4405M26	26	35	32	19	42	165	5
505168	KO4405M27	27	36.5	33	19.5	43	182	5
505169	KO4405M28	28	37.8	34	20	43	198	5
505170	KO4405M29	29	39	35	20.5	43	205	5
505171	KO4405M30	30	40	36	22	46	222	5
505172	KO4405M31	31	41.5	37	22.5	46	246	5
505173	KO4405M32	32	42.8	38	23	46	261	5
505174	KO4405M33	33	44.2	39	24	47	275	5
505175	KO4405M34	34	45.2	40	24	47	315	5
505176	KO4405M35	35	46.2	40	24	47	317	5
505177	KO4405M36	36	47.2	41	24	47	336	5
505178	KO4405M38	38	49.2	43	24	47	380	5

Item Code	Part No.	4400A (inch)	D <sub>1</sub> (mm)	D <sub>2</sub> (mm)	ℓ (mm)	L (mm)	(g)	(pcs.)
505071	KO4400A10	5/16	13.2	21	8	36	44	10
505072	KO4400A12	3/8	14.6	21	9	37	45	10
505073	KO4400A14	7/16	16.5	21	9.5	37	46	10
505074	KO4400A16	1/2	19	22	10.5	37	53	10
505075	KO4400A18	9/16	20.3	22	11	37	56	10
505076	KO4400A19	19/32	21.5	22	11.5	37	57	10
505077	KO4400A20	5/8	22.8	22	12	37	62	10
505078	KO4400A21	21/32	24	23	12.5	37	69	10
505079	KO4400A22	11/16	25	24	13	37	74	10
505080	KO4400A24	3/4	26.5	25	14	38	89	10
505081	KO4400A25	25/32	27.8	26	15	38	92	10
505082	KO4400A26	13/16	29	27	15.5	38	102	10
505083	KO4400A28	7/8	30	28	16	40	113	10
505084	KO4400A30	15/16	32.8	30	17	42	140	5
505086	KO4400A32	1	35	32	19	42	165	5
505087	KO4400A34	1. 1/16	36.5	33	19.5	43	180	5
505088	KO4400A36	1. 1/8	39	35	20.5	43	210	5
505089	KO4400A38	1. 3/16	40	36	22	46	222	5
505090	KO4400A40	1. 1/4	42.8	38	23	46	261	5
505091	KO4400A42	1. 5/16	44.2	39	24	47	275	5
505092	KO4400A44	1. 3/8	46.2	40	24	47	317	5
505093	KO4400A46	1. 7/16	47.2	41	24	47	336	5
505094	KO4400A48	1. 1/2	49.2	43	24	47	380	5

Item Code	Part No.	4400A (inch)	D <sub>1</sub> (mm)	D <sub>2</sub> (mm)	ℓ (mm)	L (mm)	(g)	(pcs.)
505125	KO4405A10	5/16	13.2	21	8	36	44	10
505126	KO4405A12	3/8	14.6	21	9	37	45	10
505127	KO4405A14	7/16	16.5	21	9.5	37	46	10
505128	KO4405A16	1/2	19	22	10.5	37	53	10
505129	KO4405A18	9/16	20.3	22	11	37	56	10
505130	KO4405A19	19/32	21.5	22	11.5	37	57	10
505131	KO4405A20	5/8	22.8	22	12	37	62	10
505132	KO4405A21	21/32	24	23	12.5	37	69	10
505133	KO4405A22	11/16	25	24	13	37	74	10
505134	KO4405A24	3/4	26.5	25	14	38	89	10
505135	KO4405A25	25/32	27.8	26	15	38	92	10
505136	KO4405A26	13/16	29	27	15.5	38	102	10
505137	KO4405A28	7/8	30	28	16	40	113	10
505138	KO4405A30	15/16	32.8	30	17	42	140	5
505139	KO4405A32	1	35	32	19	42	165	5
505140	KO4405A34	1. 1/16	36.5	33	19.5	43	180	5
505141	KO4405A36	1. 1/8	39	35	20.5	43	210	5
505142	KO4405A38	1. 3/16	40	36	22	46	222	5
505143	KO4405A40	1. 1/4	42.8	38	23	46	261	5
505144	KO4405A42	1. 5/16	44.2	39	24	47	275	5
505145	KO4405A44	1. 3/8	46.2	40	24	47	317	5
505146	KO4405A46	1. 7/16	47.2	41	24	47	336	5
505147	KO4405A48	1. 1/2	49.2	43	24	47	380	5

**Koken**

# 1/2" Sockets & Accessories

**RS4400M/10** Socket Set on Rail

**RS4405M/10**

**RS4400A/10**



Item Code	Part No.	Socket Sets	(g)
505610	KORS4400M/10	RS4400M: 10 Pieces Set/Rail 300mm 10, 11, 12, 13, 14, 15, 17, 19, 21, 22mm	717
505612	KORS4405M/10	RS4405M: 10 Pieces Set/Rail 300mm 10, 11, 12, 13, 14, 15, 17, 19, 21, 22mm	717
505608	KORS4400A/10	RS4400A: 10 Pieces Set/Rail 300mm 3/8, 7/16, 1/2, 9/16, 5/8, 11/16, 3/4, 13/16, 7/8, 15/16"	809

**4405W** 12-point Whitworth Sockets



Item Code	Part No.	4405W (W)	D <sub>1</sub> (mm)	D <sub>2</sub> (mm)	ℓ (mm)	L (mm)	(g)	(pcs.)
505179	KO4405W04	1/8	13.8	21	8.5	37	45	10
505180	KO4405W06	3/16	16.5	21	9.5	37	46	10
505181	KO4405W08	1/4	19	22	10.5	37	54	10
505182	KO4405W10	5/16	21.5	22	11.5	37	54	10
505183	KO4405W12	3/8	25	24	13	37	73	10
505184	KO4405W14	7/16	29	27	15.5	38	87	10
505185	KO4405W16	1/2	31.5	29	16.5	40	133	10
505186	KO4405W18	9/16	35	32	19	42	165	5
505187	KO4405W20	5/8	37.8	34	20	43	191	5
505188	KO4405W22	11/16	40	36	22	46	222	5
505189	KO4405W24	3/4	44.2	39	24	47	280	5
505190	KO4405W28	7/8	49.2	43	24	47	330	5

**4425** TORX® Sockets



Item Code	Part No.	4425 (E)	D <sub>1</sub> (mm)	D <sub>2</sub> (mm)	ℓ (mm)	L (mm)	(g)	(pcs.)
505191	KO4425E10	E10	13.2	21	8.2	36	44	10
505192	KO4425E12	E12	14.6	21	9.3	37	47	10
505193	KO4425E14	E14	16.5	21	10.6	37	48	10
505194	KO4425E16	E16	19	22	11.8	37	57	10
505195	KO4425E18	E18	20.3	22	13	37	57	10
505196	KO4425E20	E20	22.8	22	14.4	37	63	10
505198	KO4425E24	E24	26.5	25	17	40	95	5

**RS4425/7** TORX® Socket Set on Rail



Item Code	Part No.	Torx® Socket Set	(g)
505613	KORS4425/7	RS4425: 7 Piece Set/Rail 200mm E10, E12, E14, E16, E18, E20, E24	428

**4300M · 4300A** 6-Point Deep Sockets



Item Code	Part No.	4300M (mm)	D <sub>1</sub> (mm)	D <sub>2</sub> (mm)	ℓ (mm)	L (mm)	(g)	(pcs.)
504981	KO4300M08	8	13.2	21	9	77	76	10
504982	KO4300M09	9	13.8	21	10	77	82	10
504983	KO4300M10	10	15.3	21	11	77	82	10
504984	KO4300M11	11	16.5	21	12	77	86	10
504985	KO4300M12	12	17.8	21	13	77	92	10
504986	KO4300M13	13	19	21.8	14	77	106	10
504987	KO4300M14	14	20.3	21.8	15	77	115	10
504988	KO4300M15	15	21.5	21.8	16	77	123	10
504989	KO4300M16	16	22.8	22	17	77	141	10
504990	KO4300M17	17	24	23	18	77	139	10
504991	KO4300M18	18	25	24	19	77	149	10
504992	KO4300M19	19	26.5	25	20	77	165	10
504993	KO4300M20	20	27.8	26	21	77	183	10
504994	KO4300M21	21	29	27	23	77	190	10
504995	KO4300M22	22	30	28	27	77	200	10
504996	KO4300M23	23	31.5	29	27	77	233	10
504997	KO4300M24	24	32.8	30	27	77	249	10
504999	KO4300M25	25	34	31	27	77	270	10
505000	KO4300M26	26	35	32	27	77	279	10
505001	KO4300M27	27	36.5	33	28	77	303	10
505002	KO4300M28	28	37.8	34	28	77	331	10
505003	KO4300M29	29	39	35	28	77	357	10
505004	KO4300M30	30	40	36	34	77	342	10
505005	KO4300M31	31	41.5	37	34	77	384	10
505006	KO4300M32	32	42.8	38	34	77	405	10

Item Code	Part No.	4300A (inch)	D <sub>1</sub> (mm)	D <sub>2</sub> (mm)	ℓ (mm)	L (mm)	(g)	(pcs.)
504960	KO4300A10	5/16	13.2	21	9	77	76	10
504961	KO4300A12	3/8	14.6	21	10	77	82	10
504962	KO4300A14	7/16	16.5	21	12	77	86	10
504963	KO4300A16	1/2	19	21.8	14	77	106	10
504964	KO4300A18	9/16	20.3	21.8	15	77	115	10
504965	KO4300A19	19/32	21.5	21.8	16	77	123	10
504966	KO4300A20	5/8	22.8	22	17	77	141	10
504967	KO4300A21	21/32	24	23	18	77	139	10
504968	KO4300A22	11/16	25	24	19	77	149	10
504969	KO4300A24	3/4	26.5	25	20	77	165	10
504970	KO4300A25	25/32	27.8	26	21	77	183	10
504971	KO4300A26	13/16	29	27	23	77	190	10
504972	KO4300A28	7/8	30	28	27	77	200	10
504973	KO4300A30	15/16	32.8	30	27	77	249	10
504974	KO4300A32	1	35	32	27	77	279	10
504975	KO4300A34	1. 1/16	36.5	33	28	77	303	10
504976	KO4300A36	1. 1/8	37.8	34	28	77	331	10
504977	KO4300A38	1. 3/16	40	36	34	77	342	10
504978	KO4300A40	1. 1/4	42.8	38	34	77	405	10



# 1/2" Sockets & Accessories

## 4305M · 4305A 12-Point Deep Sockets



Item Code	Part No.	4305M (mm)	D <sub>1</sub> (mm)	D <sub>2</sub> (mm)	ℓ (mm)	L (mm)	(g)	(pcs.)
505032	KO4305M08	8	13.2	21	9	77	76	10
505033	KO4305M09	9	13.8	21	10	77	82	10
505034	KO4305M10	10	15.3	21	11	77	82	10
505035	KO4305M11	11	16.5	21	12	77	86	10
505036	KO4305M12	12	17.8	21	13	77	92	10
505037	KO4305M13	13	19	21.8	14	77	106	10
505038	KO4305M14	14	20.3	21.8	15	77	115	10
505039	KO4305M15	15	21.5	21.8	16	77	123	10
505040	KO4305M16	16	22.8	22	17	77	141	10
505041	KO4305M17	17	24	23	18	77	139	10
505042	KO4305M18	18	25	24	19	77	149	10
505043	KO4305M19	19	26.5	25	20	77	165	10
505044	KO4305M20	20	27.8	26	21	77	183	10
505045	KO4305M21	21	29	27	23	77	190	10
505046	KO4305M22	22	30	28	27	77	200	10
505047	KO4305M23	23	31.5	29	27	77	233	10
505048	KO4305M24	24	32.8	30	27	77	249	10
505049	KO4305M25	25	34	31	27	77	270	10
505050	KO4305M26	26	35	32	27	77	279	10
505051	KO4305M27	27	36.5	33	28	77	303	10
505052	KO4305M28	28	37.8	34	28	77	331	10
505053	KO4305M29	29	39	35	28	77	357	10
505054	KO4305M30	30	40	36	34	77	342	10
505055	KO4305M31	31	41.5	37	34	77	384	10
505056	KO4305M32	32	42.8	38	34	77	405	10
505057	KO4305M34	34	45.2	40	35	77	442	5
505058	KO4305M36	36	48	43	36	77	484	5

Item Code	Part No.	4305A (inch)	D <sub>1</sub> (mm)	D <sub>2</sub> (mm)	ℓ (mm)	L (mm)	(g)	(pcs.)
505013	KO4305A10	5/16	13.2	21	9	77	76	10
505014	KO4305A12	3/8	14.6	21	10	77	82	10
505015	KO4305A14	7/16	16.5	21	12	77	86	10
505016	KO4305A16	1/2	19	21.8	14	77	106	10
505017	KO4305A18	9/16	20.3	21.8	15	77	115	10
505018	KO4305A19	19/32	21.5	21.8	16	77	123	10
505019	KO4305A20	5/8	22.8	22	17	77	141	10
505020	KO4305A21	21/32	24	23	18	77	139	10
505021	KO4305A22	11/16	25	24	19	77	149	10
505022	KO4305A24	3/4	26.5	25	20	77	165	10
505023	KO4305A25	25/32	27.8	26	21	77	183	10
505024	KO4305A26	13/16	29	27	23	77	190	10
505025	KO4305A28	7/8	30	28	27	77	200	10
505026	KO4305A30	15/16	32.8	30	27	77	249	10
505027	KO4305A32	1	35	32	27	77	279	10
505028	KO4305A34	1. 1/16	36.5	33	28	77	303	10
505029	KO4305A36	1. 1/8	37.8	34	28	77	331	10
505030	KO4305A38	1. 3/16	40	36	34	77	342	10
505031	KO4305A40	1. 1/4	42.8	38	34	77	405	10

## RS4300M/10

Socket Set on Rail

## RS4305M/10

## RS4300A/10

Socket Set on Rail

## RS4305A/10



Item Code	Part No.	Deep Socket Sets	(g)
505604	KORS4300M/10	<b>RS4300M (6 Point):</b> 10 Pieces Set/Rail 300mm 10, 11, 12, 13, 14, 15, 17, 19, 21, 22mm	1,415
505606	KORS4305M/10	<b>RS4305M (12 Point):</b> 10 Pieces Set/Rail 300mm 10, 11, 12, 13, 14, 15, 17, 19, 21, 22mm	1,415
505603	KORS4300A/10	<b>RS4300A (6 Point):</b> 10 Pieces Set/Rail 300mm 3/8, 7/16, 1/2, 9/16, 5/8, 11/16, 3/4, 13/16, 7/8, 15/16"	1,415
505605	KORS4305A/10	<b>RS4305A (12 Point):</b> 10 Pieces Set/Rail 300mm 3/8, 7/16, 1/2, 9/16, 5/8, 11/16, 3/4, 13/16, 7/8, 15/16"	1,415

## 4325 TORX® Deep Sockets



Item Code	Part No.	4325 (E)	D <sub>1</sub> (mm)	D <sub>2</sub> (mm)	ℓ (mm)	L (mm)	(g)	(pcs.)
505063	KO4325E10	E10	13.2	21	8.2	77	99	10
505064	KO4325E12	E12	14.6	21	9.3	77	99	10
505065	KO4325E14	E14	16.5	21	10.6	77	103	10
505066	KO4325E16	E16	19	21.8	11.8	77	107	10
505067	KO4325E18	E18	20.3	21.8	13	77	118	10
505068	KO4325E20	E20	22.8	22	14.4	77	141	10

## 4445A 12-Point Universal Sockets



Item Code	Part No.	4445A (inch)	D <sub>1</sub> (mm)	D <sub>2</sub> (mm)	ℓ (mm)	L (mm)	(g)	(pcs.)
505202^	KO4445A12	3/8	14.8	25	8.8	63	155	10
505203^	KO4445A14	7/16	16.5	25	10	65	158	10
505204^	KO4445A16	1/2	19	25	11.4	66	152	10
505205^	KO4445A18	9/16	20.3	25	11.4	66	151	10
505206^	KO4445A20	5/8	22.8	25	13	68	150	10
505207^	KO4445A22	11/16	24.6	25	14	69	153	10

# 1/2" Sockets & Accessories

## RS4010M/10-L75 Socket Set on Rail



Item Code	Part No.	Inhex Socket Sets	(g)
505594	KORS4010M75/10	4010M.75: 10 Piece Set/Rail 300mm 4, 5, 6, 7, 8, 10, 12, 14, 17, 19mm	1,207

## 4020-60 XZN Bit Sockets



Item Code	Part No.	4020.60 (XZN)	D (mm)	L (mm)	(g)	(pcs.)
504843	KO4020-60/M5	M 5	22	60	60	10
504844	KO4020-60/M6	M 6	22	60	61	10
504845	KO4020-60/M8	M 8	22	60	63	10
504846	KO4020-60/M10	M10	23	60	93	10
504847	KO4020-60/M12	M12	23	60	97	10
504848	KO4020-60/M14	M14	24	60	105	10
504849	KO4020-60/M16	M16	25	60	165	10
504850	KO4020-60/M18	M18	27	60	215	10

## RS4020/6-L60 XZN Socket Set on Rail



Item Code	Part No.	Socket Set	(g)
505597	KORS4020/6-L60	4020 XZN: 6 Piece Set / Rail 150mm M5, M6, M8, M10, M12, M14	500



XZN	M4	M5	M6	M8	M10	M12	M14	M16	M18
S (ref. mm)	3.6	4.8	6.0	7.2	9.6	11.41	13.22	15.63	16.85

## 4025 (T) TORX® Bit Sockets



Item Code	Part No.	4025.60 (T)	D (mm)	L (mm)	(g)	(pcs.)
504851	KO4025-60T20	T20	22	60	59	10
504852	KO4025-60T25	T25	22	60	60	10
504853	KO4025-60T27	T27	22	60	60	10
504854	KO4025-60T30	T30	22	60	60	10
504855	KO4025-60T40	T40	22	60	62	10
504856	KO4025-60T45	T45	22	60	64	10
504857	KO4025-60T50	T50	22	60	74	10
504858	KO4025-60T55	T55	23	60	96	10
504859	KO4025-60T60	T60	24	60	122	10

## RS4025/9-L60 TORX® Socket Set on Rail



Item Code	Part No.	Inhex Socket Sets	(g)
505598	KORS4025/9	4025.60 (T): 9 Piece Set/Rail 250mm T20, T25, T27, T30, T40, T45, T50, T55, T60	700

## RS4025/9-IP TORXplus® Socket Set on Rail



Item Code	Part No.	Inhex Socket Sets	(g)
505599^	KORS4025/9-IP	4025 (IP): 9 Piece Set/Rail 250mm 20IP, 25IP, 27IP, 30IP, 40IP, 45IP, 50IP, 55IP, 60IP	700

## RS4027/6-L60 Ribe CV Socket Set on Rail



Item Code	Part No.	Socket Set	(g)
505600^	KORS4027/6-L60	4027.60 XZN: 6 Piece Set / Rail 200mm M5, M6, M8, M10, M12, M14	600

### TORXplus® (IP)



IP	8IP	9IP	10IP	15IP	20IP	25IP	27IP	30IP	40IP	45IP	50IP	55IP	60IP	70IP
S (ref. mm)	2.29	2.48	2.72	3.25	3.84	4.39	4.95	5.49	6.60	7.77	8.79	11.16	13.20	15.49

# 1/2" Sockets & Accessories

**4012M 4012A** Inhex sockets, non-impact



Item Code	Part No.	4012M.60 (mm)	D (mm)	ℓ (mm)	L (mm)	(g)	(pcs.)
504824	KO4012M6004	4	21.1	15.5	60	50	10
504825	KO4012M6005	5	21.1	15.5	60	55	10
504826	KO4012M6006	6	21.1	15.5	60	56	10
504827	KO4012M6007	7	21.1	15.5	60	60	10
504828	KO4012M6008	8	21.1	15.5	60	64	10
504829	KO4012M6009	9	21.1	15.5	60	70	10
504830	KO4012M6010	10	23	15.5	60	90	10
504831	KO4012M6012	12	25	15.5	60	115	10
504832	KO4012M6014	14	25	15.5	60	130	10
504833	KO4012M6015	15	26	15.5	60	145	10
504834	KO4012M6016	16	26	15.5	60	155	10
504835	KO4012M6017	17	26	15.5	60	160	10
504836	KO4012M6019	19	26	15.5	60	180	10
504837	KO4012M6021	21	26	15.5	60	200	10
504838	KO4012M6022	22	26	22.5	60	205	10
504839	KO4012M6024	24	28	22.5	60	240	10

Item Code	Part No.	4012A.60 (inch)	D (mm)	ℓ (mm)	L (mm)	(g)	(pcs.)
504814	KO4012A6005	5/32	21.1	15.5	60	49	10
504815	KO4012A6006	3/16	21.1	15.5	60	55	10
504816	KO4012A6008	1/4	21.1	15.5	60	57	10
504817	KO4012A6010	5/16	21.1	15.5	60	64	10
504818	KO4012A6012	3/8	23	15.5	60	90	10
504819	KO4012A6014	7/16	25	15.5	60	115	10
504820	KO4012A6016	1/2	25	15.5	60	120	10
504821	KO4012A6018	9/16	25	15.5	60	130	10
504822	KO4012A6020	5/8	26	15.5	60	155	10
504823	KO4012A6024	3/4	26	15.5	60	180	10

4012M/A are for hand use only. Do not use with an impact wrench.

**RS4012M/10-L60** Socket Set on Rail



Item Code	Part No.	Inhex Socket Sets	(g)
505596	KORS4012M60/10	4012M.60: 10 Piece Set/Rail 300mm 4, 5, 6, 7, 8, 10, 12, 14, 17, 19mm	910

4012M/A are for hand use only. Do not use with an impact wrench.

**RS4012A/10-L60** Socket Set on Rail



Item Code	Part No.	Inhex Socket Sets	(g)
505595	KORS4012A60/10	4012A.60: 10 Piece Set/Rail 300mm 3/16, 7/32, 1/4, 5/16, 3/8, 7/16, 1/2, 9/16, 5/8, 3/4"	950

4012M/A are for hand use only. Do not use with an impact wrench.

**3749S-1/2** Reversible Ratchet Short



\* Renewal Kits → 3749SRK-1/2

Item Code	Part No.	D (mm)	T (mm)	H (mm)	L (mm)	(g)	(pcs.)
504752	KO3749S-1/2	34	29	14.4	110	200	5

**4749N** Reversible Ratchet

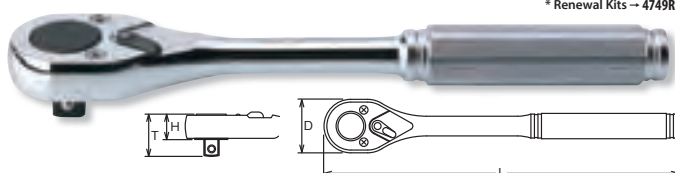

\* Renewal Kits → 4749RK

Item Code	Part No.	D (mm)	T (mm)	H (mm)	L (mm)	(g)	(pcs.)
505214	KO4749N-250	44.6	33	18.4	250	616	1
505215	KO4749N-380	44.6	33	18.4	380	753	1

**[4750 series]**



Two dogs are set in the same axis and the three teeth hold the ratchet gear. The enlarged contact area produces an about 10% higher torque value and the S.O.D.H. system provides smooth and light movements.

**4750P** Reversible Ratchet

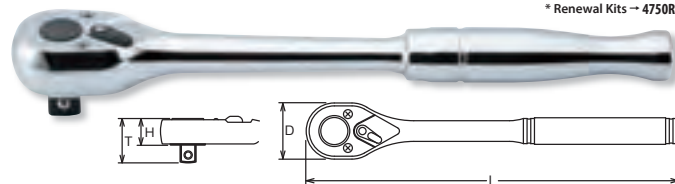

\* Renewal Kits → 4750RK

Item Code	Part No.	D (mm)	T (mm)	H (mm)	L (mm)	(g)	(pcs.)
505220	KO4750P	38	35.9	21.3	250	553	1

# 1/2" Sockets & Accessories

## 4750PB

Reversible Ratchet with quick release button



\* Renewal Kits → 4750BRK

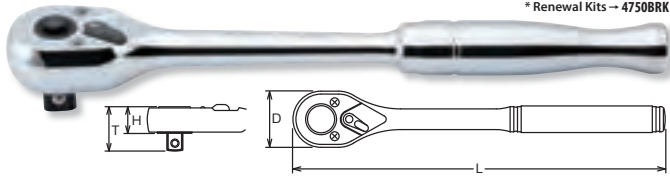

Item Code	Part No.	D (mm)	T (mm)	H (mm)	L (mm)	(g)	(pcs.)
505221 <sup>^</sup>	KO4750PB	38	35.9	21.3	250	553	1

⚠ Reversible Ratchet with quick release button has less strength compared with normal ratchet due to the technical design. Make sure to use the ratchet correctly.



**Reversible Ratchet with Quick Release Button :**  
Sockets and accessories are safely locked.  
By pushing the button the sockets or extension bars are released from the ratchet.

## 4752N

Reversible Ratchet



\* Renewal Kits → 4752RK

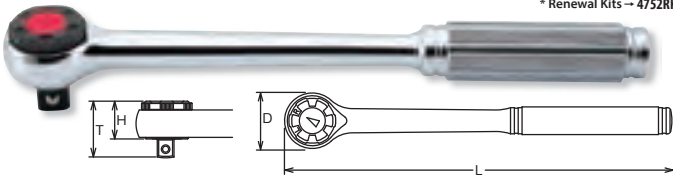

Item Code	Part No.	D (mm)	T (mm)	H (mm)	L (mm)	(g)	(pcs.)
505223	KO4752N	35	38.8	24.5	250	480	1



### [L/R Marking]

A pointer and L/R markings on the ratchet head indicate the turning direction. The reduced diameter of the head allows easier access in tight spots.

## 4753N

Reversible Ratchet



\* Renewal Kits → 4753RK



## 4753P

Reversible Ratchet



\* Renewal Kits → 4753RK

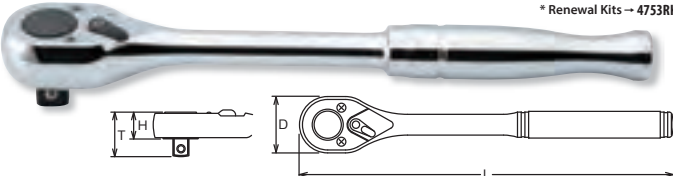

Item Code	Part No.	D (mm)	T (mm)	H (mm)	L (mm)	(g)	(pcs.)
505226	KO4753N	38	36.2	21.6	250	595	1
505228	KO4753P	38	36.2	21.6	250	570	1
505229	KO4753P-410	38	36.2	21.6	410	790	1

## 4753NB

Reversible Ratchet with quick release button



\* Renewal Kits → 4753BRK

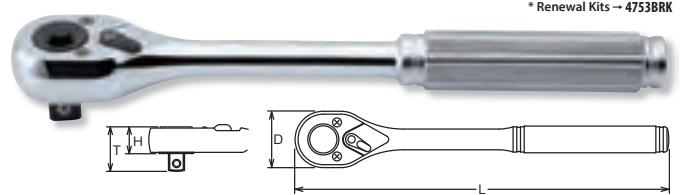

Item Code	Part No.	D (mm)	T (mm)	H (mm)	L (mm)	(g)	(pcs.)
505227 <sup>^</sup>	KO4753NB	38	36.2	21.6	250	595	1

⚠ Reversible Ratchet with quick release button has less strength compared with normal ratchet due to the technical design. Make sure to use the ratchet correctly.

## 4774N

Flexible Ratchet, Reversible



\* Renewal Kits → 4753RK

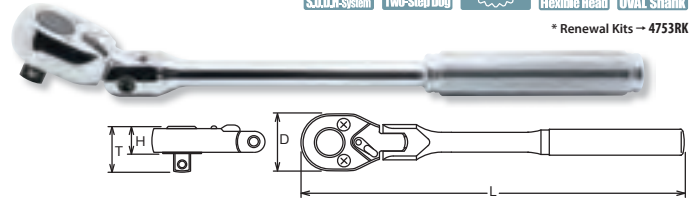

Item Code	Part No.	D (mm)	T (mm)	H (mm)	L (mm)	(g)	(pcs.)
505258	KO4774N	38	36.2	21.6	330	700	1

## 4774P

Flexible Ratchet, Reversible



\* Renewal Kits → 4753RK

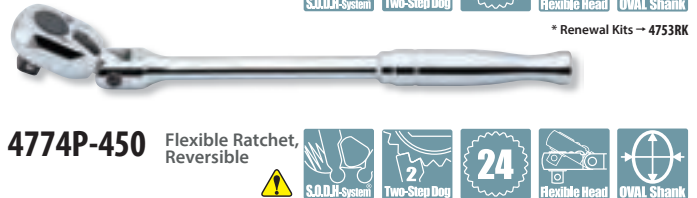

## 4774P-450

Flexible Ratchet, Reversible



\* Renewal Kits → 4753RK

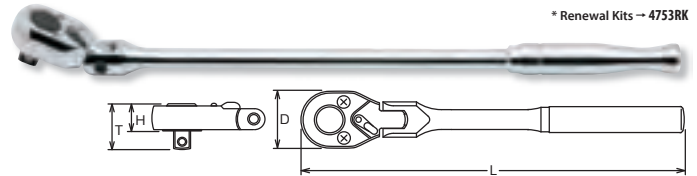

Item Code	Part No.	D (mm)	T (mm)	H (mm)	L (mm)	(g)	(pcs.)
505259	KO4774P	38	36.2	21.6	330	700	1
505260	KO4774P-450	38	36.2	21.6	450	790	1

⚠ 4774P-450 has longer handle than standard, and can be loaded to excessive torque value. In the interest of your own safety always apply load evenly and progressively to avoid breakage and possible injury.

# 1/2" Sockets & Accessories

## Renewal Kit

**4749RK** 4749N-250  
4749N-380 Reversible Ratchet Renewal Kit



**4753RK** 4753N, 4753P, 4753P-410, 4753J, D4753J  
4774N, 4774P, 4774P-450, 4774J

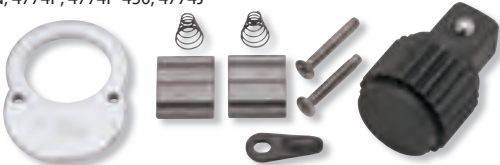

**4768RK** 4768N, 4768P, 4768J, 4781N-450



Item Code	Part No.		(g)	(pce.)
505217	KO4749RK	1/2"	130	1
505230	KO4753RK		130	1
505254	KO4768RK		60	1

**4768N300** Hinge Handle



\* Renewal Kits → 4768RK



**4768N380** - 450 Hinge Handle



\* Renewal Kits → 4768RK



**4768P380** Hinge Handle



\* Renewal Kits → 4768RK



Item Code	Part No.	D (mm)	L (mm)	(g)	(pcs.)
505246	KO4768N300	28	300	600	2
505247	KO4768N380	28	380	696	2
505248	KO4768N450	28	450	784	2
505252	KO4768P380	28	380	665	2

KO4768450 has longer handle than standard, and can be loaded to excessive torque value. Please use carefully.

**4768N-600** Hinge Handle



\* Renewal Kits → 4768RK

**4768P-600** Hinge Handle



\* Renewal Kits → 4768RK

**4768J-600** Hinge Handle



\* Renewal Kits → 4768RK

Item Code	Part No.	D (mm)	L (mm)	(g)	(pce.)
505251	KO4768N600	28	600	1100	1
505253	KO4768P600	28	600	1170	1
505250	KO4768J600	28	600	1120	1

4768-600 has longer handle than standard, and can be loaded to excessive torque value. In the interest of your own safety always apply load evenly and progressively to avoid breakage and possible injury.

**4755** Ratchet Adaptor



45

\* Renewal Kits → 4755RK

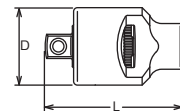

Item Code	Part No.	D (mm)	L (mm)	(g)	(pcs.)
505232	KO4755	33.5	65	270	5

**4770** Universal Joint

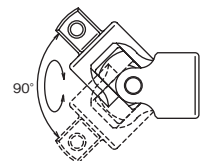
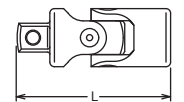

Item Code	Part No.	L (mm)	(g)	(pcs.)
505255	KO4770	62.4	150	10

**4771** Universal Joint

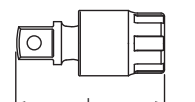

Item Code	Part No.	L (mm)	(g)	(pcs.)
505257	KO4771	57.7	113	10

**Koken**

# 1/2" Sockets & Accessories

## 4760 Extension Bars



Item Code	Part No.	D (mm)	L (mm)	(g)	(pcs.)
505234	KO4760050	24	50	92	10
505235	KO4760075	24	75	138	10
505236	KO4760100	24	100	158	5
505237	KO4760125	24	125	194	5
505238	KO4760250	24	250	358	5
505239	KO4760400	24	400	650	1
505240	KO4760500	24	500	808	1
505241	KO4760600	24	600	968	1
505236	KO47601000	24	1000	1593	1

## PK4763/5 Wobble-Fix Extension Bar Set



5 Piece Set  
PLASTIC TRAY

Item Code	Part No.	Extension Bars	(g)
505539	KOPK4763/5	4763 Wobble-Fix Extension Bars 50, 75, 125, 150, 250	950

## PK4760/5 Set



5 Piece Set  
PLASTIC TRAY

Item Code	Part No.	Extension Bars	(g)
505538	KOPK4760/5	4760 Extension Bars 50, 75, 125, 150, 250mm	1050

## 4780 Speed Handle

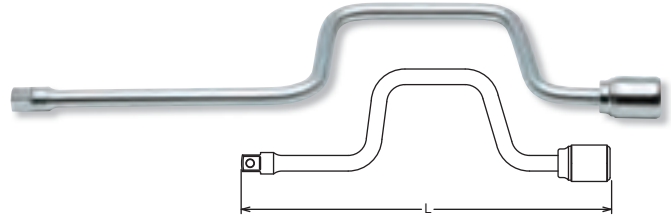

Item Code	Part No.	L (mm)	(g)	(pce.)
505262	KO4780400	400	644	1
505263	KO4780450	450	730	1

## 4763 Wobble-Fix Extension Bars

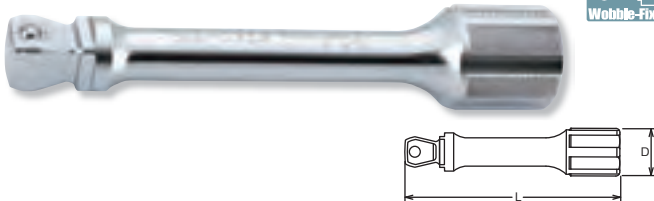

Item Code	Part No.	D (mm)	L (mm)	(g)	(pcs.)
505242	KO4763050	24	50	95	10
505243	KO4763075	24	75	111	10
505244	KO4763125	24	125	157	5
511188	KO4763150	24	150	181	5
505245	KO4763250	24	250	267	5

The Wobble-Fix Extension Bar has less strength than normal extension bar due to its specific design with a reduced square drive. Make sure to use it correctly.

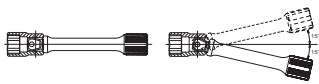

**Wobble-Fix Extension Bar**  
Two way usage : one for as a flexible extension bar to provide at 15° angle operation, the other for use as a normal extension bar. This 2-way usage is Patented.

## 4785 T-Handle

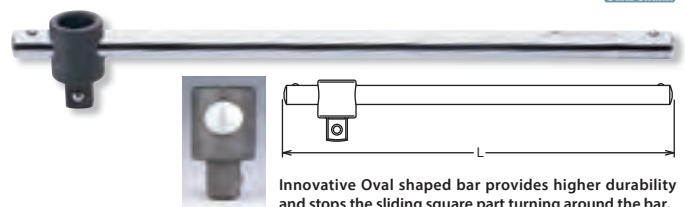

Innovative Oval shaped bar provides higher durability and stops the sliding square part turning around the bar.

Item Code	Part No.	L (mm)	(g)	(pcs.)
505265	KO4785	300	410	2

## 4747 L-Handle

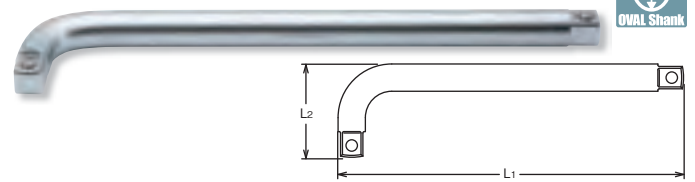

Item Code	Part No.	L1 (mm)	L2 (mm)	(g)	(pce.)
505213	KO4747	260	50	470	1

# 1/2" Sockets & Accessories

## 4433A35 Reducer Adaptor

Warranty 290Nm

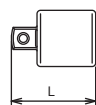

Item Code	Part No.	□ (sq.)	□ (sq.)	L (mm)	⚖ (g)	◇ (pcs.)
505199	KO4433A35	1/2"	3/8"	35	50	10

Adapting down from bigger square drive to smaller square drive may lead to excessive torque and possibly cause breakage.

### Tolerances

4100M (mm)		4100A (inch)	
5	4.7- 5	1/4	6 - 6.4
6	5.6- 6	5/16	7.6- 8
7	6.6- 7	3/8	9 - 9.6
8	7.6- 8	7/16	10.5-11.1
9	8.4- 9	1/2	12.1-12.7
10	9.4-10	9/16	13.5-14.3
10.5	9.9-10.5	5/8	15.2-16
11	10.4-11		
12	11.4-12		
14	13.2-14		
16	15.2-16		

## 4466A Adaptor

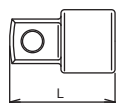

Item Code	Part No.	□ (sq.)	□ (sq.)	L (mm)	⚖ (g)	◇ (pcs.)
505210	KO4466A	1/2"	3/4"	42	108	10

## 4211M · 4211A Screw and Stud Pullers Sets



METAL CASE:W215xH80xT47mm

Item Code	Part No.	○	Puller Sets	⚖ (g)
504923	KO4211M	○	4100M Stud Pullers: 4 Piece Set 6, 8, 10, 12	1,040
504922	KO4211A	○	4100A Stud Pullers: 4 Piece Set 1/4, 5/16, 3/8, 1/2"	1,040

## 4100M · 4100A Screw and Stud Pullers

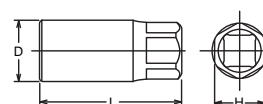
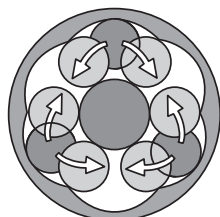

Screw and Stud Pullers  
Hexagon body design can lessen the excessive load on cages and rollers inside the pullers.

Item Code	Part No.	4100M (mm)	□	D (mm)	L (mm)	H (mm)	⚖ (g)	◇ (pcs.)	
504879	KO4100M06	6	1/2"	24	65	21	150	10	
504880	KO4100M07	7		24	65	21	150	10	
504881	KO4100M08	8		24	65	21	147	10	
504882	KO4100M09	9		28	75	21	217	10	
504883	KO4100M10	10		28	75	21	213	10	
504884	KO4100M10.5	10.5		28	75	21	202	10	
504885	KO4100M11	11		28	75	21	218	10	
504886	KO4100M12	12		28	75	21	220	10	
504887	KO4100M14	14		34	75	27	340	5	
504888	KO4100M16	16		-	34	75	27	315	5

Item Code	Part No.	4100A (inch)	□	D (mm)	L (mm)	H (mm)	⚖ (g)	◇ (pcs.)	
504861	KO4100A08	1/4	1/2"	24	65	21	150	10	
504862	KO4100A10	5/16		24	65	21	147	10	
504863	KO4100A12	3/8		28	75	21	213	10	
504864	KO4100A14	7/16		28	75	21	218	10	
504865	KO4100A16	1/2		28	75	21	191	10	
504866	KO4100A18	9/16		34	75	27	340	5	
504867	KO4100A20	5/8		-	34	75	27	315	5

\* Renewal Kits → 4100RK → P279

4100M-16 and 4100A-5/8 do not have 1/2" square drive.  
Drive the outer hexagon part with 27mm sockets or ring wrenches.

## 4214M Screw and Stud Pullers Set



METAL CASE:W215xH80xT47mm





5 Pieces Set/⚖=1,450g

Item Code	Part No.	○	Puller Set
504924	KO4214M	○	4100M Stud Pullers 6, 8, 10, 12, 14

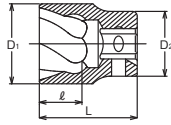
# 1/2" Sockets & Accessories

## 4127 NUTTWISTER®







Item Code	Part No.	4127 (mm)		D <sub>1</sub> (mm)	D <sub>2</sub> (mm)	l (mm)	L (mm)	 (g)	 (pcs.)
504909 <sup>^</sup>	KO4127M14	14		19.7	30	14	42	125	10
504910 <sup>^</sup>	KO4127M17	17		23.5	30	16	42	137	10
504911 <sup>^</sup>	KO4127M19	19		26	30	16	42	146	10
504912 <sup>^</sup>	KO4127M21	21		28	30	17	42	153	10
504913 <sup>^</sup>	KO4127M22	22		29.5	30	17	42	158	10
504914 <sup>^</sup>	KO4127M24	24		32	30	18	42	174	10
504915 <sup>^</sup>	KO4127M25.4	25.4		33.5	30	18	42	183	10

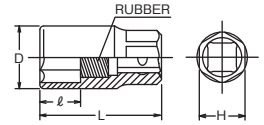

 A very effective method and easy solution for removing rounded off nuts, bolts and studs. The sharp edges of the NUTTWISTER Socket opening will tighten around the nut, bolt or stud and turn it easily off.

## 4300S Spark Plug Sockets with Rubber



Item Code	Part No.	4300S (mm)		D (mm)	l (mm)	L (mm)	H (mm)	 (g)	 (pcs.)
505010 <sup>^</sup>	KO4300S16	16		21	19	70	21	100	10
505011 <sup>^</sup>	KO4300S18	18		23.9	21	70	21	130	10
505012 <sup>^</sup>	KO4300S20.6	20.8		26.9	27	70	22	135	10

## 4020-60 (MH) Bit Socket for XZN-Screws with hole

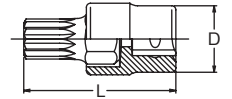



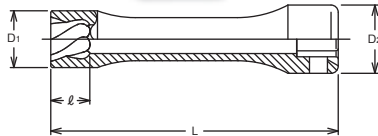

**4020-60-MH16**  
Specially designed for oil drain plug on gearbox of AUDI, VW, PORSCHE.

Item Code	Part No.	4020.60 (XZN)		D (mm)	L (mm)	 (g)	 (pcs.)
504842	KO4020-60/MH16	MH16		24	60	135	10





## 4128-120 NUTTWISTER® (Long type)

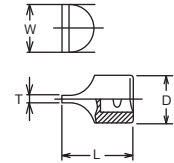

Item Code	Part No.	4128,120 (mm)		D <sub>1</sub> (mm)	D <sub>2</sub> (mm)	l (mm)	L (mm)	 (g)	 (pcs.)
504916 <sup>^</sup>	KO4128L120M19	19		28.4	30	16	120	247	10
504917 <sup>^</sup>	KO4128L120M21	21		31	30	17	120	262	10





## 4101 Drag Link Sockets for Slotted Heads

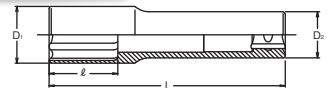

Item Code	Part No.	4101		T×W (mm)	D (mm)	L (mm)	 (g)	 (pcs.)
504905	KO4101/1	1		2.7×18.6	22	40	59	10
504906	KO4101/2	2		3.7×24	24	40	79	10
504907	KO4101/3	3		3.7×30	30	40	128	10

## 4300M (L110) Wheel Nut Sockets (Long)





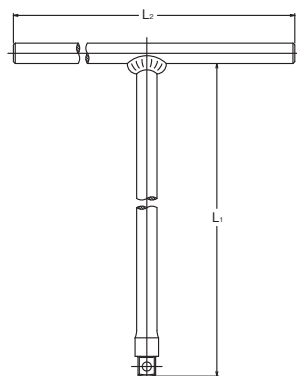

Item Code	Part No.	4300M(L110) (mm)		D <sub>1</sub> (mm)	D <sub>2</sub> (mm)	l (mm)	L (mm)	 (g)	 (pcs.)
505007 <sup>^</sup>	KO4300M-L110/17	17		23	22	32	110	155	10
505008 <sup>^</sup>	KO4300M-L110/19	19		25.8	22	32	110	170	10
505009 <sup>^</sup>	KO4300M-L110/21	21		26.8	22	32	110	165	10

 Please note that thin walled design is only for wheel nut work and Torque rating is limited.

## 4715 T-Handle



Item Code	Part No.		L1 (mm)	L2 (mm)	 (g)	 (pce.)
505212	KO4715		267	255	475	1



# 1/2" Sockets & Accessories

**4012M/10-L60** **4012A/10-L60**

Socket Set - L60mm Inhex Socket



METAL CASE:W310xH100xT40mm

Item Code	Part No.	Hex Bit Socket Sets	(g)
511194	KO4012M/10-L60	<b>4012M-60: 10 Piece Set</b> 5, 6, 8, 10, 12, 13, 14, 16, 17, 19mm	1,600
511195	KO4012A/10-L60	<b>4012A-60: 10 Piece Set</b> 3/16, 7/32, 1/4, 5/16, 3/8, 7/16, 1/2, 9/16, 5/8, 3/4"	1,500

**4239AM** **4239AMP**

Socket Set



39 Piece Set  
METAL CASE:W446xH266xT50mm = 6,940g

Item Code	Part No.	Sockets	Accessories
504933	KO4239AM	<b>4405M 12-pt. Sockets</b> 10, 11, 12, 13, 14, 15, 17, 18, 19, 21, 22, 23, 24, 26, 27, 30, 32mm	4753N 4760-75
		<b>4405A 12-pt. Sockets</b> 3/8, 7/16, 1/2, 9/16, 5/8, 11/16, 3/4, 13/16, 7/8, 15/16, 1, 1.1/16, 1.1/8, 1.3/16, 1.1/4"	4760-125 4760-250 4770
		<b>4300C S/Plug Sockets</b> 20.8mm	4785

39 Piece Set  
PLASTIC TRAY = 5,900g

Item Code	Part No.	Sockets	Accessories
504934	KO4239AMP	<b>4405M 12-pt. Sockets</b> 10, 11, 12, 13, 14, 15, 17, 18, 19, 21, 22, 23, 24, 26, 27, 30, 32mm	4753N 4760-75
		<b>4405A 12-pt. Sockets</b> 3/8, 7/16, 1/2, 9/16, 5/8, 11/16, 3/4, 13/16, 7/8, 15/16, 1, 1.1/16, 1.1/8, 1.3/16, 1.1/4"	4760-125 4760-250 4770
		<b>4300C S/Plug Sockets</b> 20.8mm	4785

**4241M** Socket Set



28 Piece Set  
METAL CASE:W445xH190xT50mm = 6,500g

Item Code	Part No.	Sockets	Accessories
504939	KO4241M	<b>4405M 12-pt. Sockets</b> 10, 11, 12, 13, 14, 15, 16, 17, 18, 19, 20, 21, 22, 23, 24, 25, 26, 27, 28, 29, 30, 32	4753N 4760-125 4760-250 4768N-380 4770 4785

**4251M · 4251A** Socket Sets



METAL CASE:W330xH68xT48mm

Item Code	Part No.	Socket Sets	(g)
504947	KO4251M	<b>22 Piece Socket Set</b> <b>4405M 12-pt. Sockets</b> 10, 11, 12, 13, 14, 15, 16, 17, 18, 19, 20, 21, 22, 23, 24, 25, 26, 27, 28, 29, 30, 32mm	3,200
504948	KO4251M-6P	<b>22 Piece Socket Set</b> <b>4405M 6-pt. Sockets</b> 10, 11, 12, 13, 14, 15, 16, 17, 18, 19, 20, 21, 22, 23, 24, 25, 26, 27, 28, 29, 30, 32mm	3,200
504945	KO4251A	<b>18 Piece Socket Set</b> <b>4405A 12-pt. Sockets</b> 3/8, 7/16, 1/2, 9/16, 5/8, 19/32, 21/32, 11/16, 3/4, 25/32, 13/16, 7/8, 15/16, 1, 1.1/16, 1.1/8, 1.3/16, 1.1/4"	2,660

**4267W** Socket Set



14 Piece Set  
METAL CASE:W395xH90xT50mm = 3,150g

Item Code	Part No.	Sockets	Accessories
504953	KO4267W	<b>4405W 12-pt. W/worth Sockets</b> 1/8, 3/16, 1/4, 5/16, 3/8, 7/16, 1/2, 9/16, 5/8, 11/16"	4753N 4760-125 4768N-380 4710

**Koken**

# 1/2" Sockets & Accessories







**4274AMW**

Socket Set

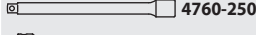

50 Piece Set  
METAL CASE

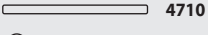
⚖ = 10,000g

Item Code	Part No.	Sockets	Accessories
504956	KO4274AMW	<b>4405M</b> 12-pt. Sockets 8, 9, 10, 11, 12, 13, 14, 15, 16, 17, 18, 19, 20, 21, 22, 23, 24, 26, 27, 29, 30mm	 <b>4770</b>  <b>4753N</b>
		<b>4405A</b> 12-pt. Sockets 3/8, 7/16, 1/2, 9/16, 19/32, 5/8, 11/16, 3/4, 7/8, 15/16, 1"	 <b>4760-125</b>  <b>4760-250</b>  <b>4768N-380</b>
		<b>4405A</b> 12-pt. W/worth Sockets 11/16, 5/8, 9/16, 1/2, 7/16, 3/8, 5/16, 1/4, 3/16"	 <b>4710</b>  <b>4785</b>  <b>4780</b>
		<b>4305A</b> 12-pt. Deep Socket 13/16"	





**4279AM**

Socket Set

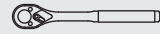

36 Piece Set  
METAL CASE:W445xH190xT50mm

⚖ = 6,000g

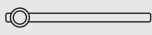
Item Code	Part No.	Sockets	Accessories
504958	KO4279AM	<b>4405M</b> 12-pt. Sockets 10, 11, 12, 13, 14, 15, 16, 17, 18, 19, 21, 22, 23, 24, 26, 27, 30, 32mm	 <b>4753N</b>  <b>4760-125</b>  <b>4760-250</b>
		<b>4405A</b> 12-pt. Sockets 3/8, 7/16, 1/2, 9/16, 5/8, 11/16, 3/4, 13/16, 7/8, 15/16, 1.1/16, 1.1/8, 1.1/4"	 <b>4770</b>  <b>4785</b>

# Miscellaneous Automotive Tools

## ST4027-140 Head Bolt Bit Socket for VW/AUDI

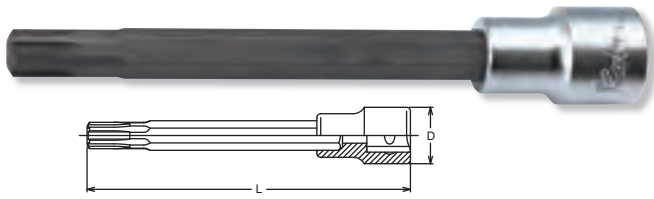

Item Code	Part No.		D (mm)	L (mm)	(g)	(pcs.)
505620	KOST4027.140	1/2"	23	140	155	10



**Head Bolt Bit Socket for VW/AUDI**  
ST4027-140 can not substitute with 3027, 4027-CV bit series.

## 4282 XZN and TORX® Generator Service Set

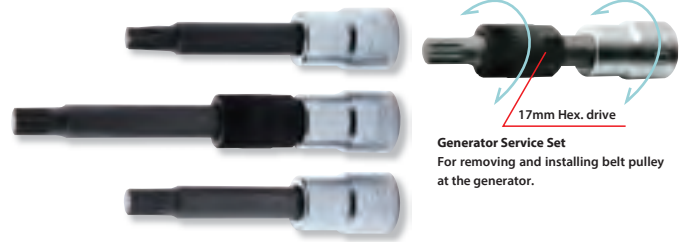

**Generator Service Set**  
For removing and installing belt pulley at the generator.

4 Piece Set  
PLASTIC BAG

= 449g

Item Code	Part No.	Sockets	
504959 <sup>^</sup>	KO4282		4020.100-M10 4020.140-M10
			4025.100R-T50
			185

## 4202 Drain Plug Keys Set



7 Piece Set  
METAL CASE:W190xH59xT45mm

= 426g

Item Code	Part No.	Sockets	
504919	KO4202		<b>106 Drain Plug Keys</b> 8Sx10S, 8Hx3/8H, 10Hx11H, 12Hx13H, 14Hx17H, 19H
			4102 Drain Plug Key Adaptor

## 145LH3/8F Belt Tension Pulley Wrench

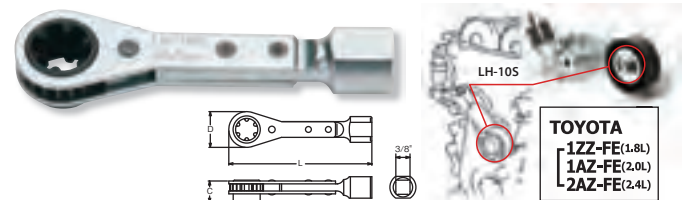

**TOYOTA**  
1ZZ-FE(1.8L)  
1AZ-FE(2.0L)  
2AZ-FE(2.4L)

**Belt Tension Pulley Wrench**  
For LH-10S bolt on TOYOTA engines 1ZZ (1.8L), 1AZ (2.0L) and 2AZ (2.4L), belt tension pulley.

Item Code	Part No.		L (mm)	D (mm)	C (mm)	(g)	(pcs.)
503873 <sup>^</sup>	KO145LH3/8F-10S	3/8"	100	25	15.5	90	10

This item has less strength due to the special design.

## 106 4-point Male bits

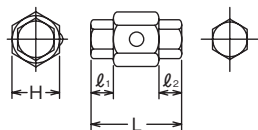

Item Code	Part No.	H (mm)	l1 (mm)	l2 (mm)	L (mm)	(g)	(pcs.)
503625 <sup>^</sup>	KO106-8Sx10S	17	8	8	32	40	10

# 3/4" Sockets & Accessories

6405M · 6405A 

12-point Sockets

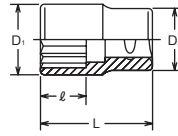

Item Code	Part No.	6405M (mm)	D <sub>1</sub> (mm)	D <sub>2</sub> (mm)	ℓ (mm)	L (mm)	(g)	(pcs.)
505383	KO6405M17	17	26	34	12.5	50	175	5
505384	KO6405M18	18	27	34	13	50	178	5
505385	KO6405M19	19	28.5	34	13.5	50	179	5
505386	KO6405M20	20	29.5	34	14	50	185	5
505387	KO6405M21	21	31	34	14.5	50	185	5
505388	KO6405M22	22	32	34	15	50	187	5
505389	KO6405M23	23	33.5	34	16	50	187	5
505390	KO6405M24	24	34.5	34	17	50	200	5
505391	KO6405M25	25	36	34	17.5	50	217	5
505392	KO6405M26	26	37	34	18	50	222	5
505393	KO6405M27	27	38.5	37	19	53	254	5
505394	KO6405M28	28	39.5	38	19.5	53	298	5
505395	KO6405M29	29	41	38	20	55	292	5
505396	KO6405M30	30	42	38	21	55	301	5
505397	KO6405M31	31	43.5	38	22	57	294	5
505398	KO6405M32	32	44.5	40	23	57	351	5
505399	KO6405M33	33	46	40	23.5	57	384	5
505400	KO6405M34	34	47	40	24	57	397	5
505401	KO6405M35	35	48.5	42	24.5	59	422	5
505402	KO6405M36	36	49.5	42	25	59	438	5
505403	KO6405M37	37	51	42	25.5	59	484	5
505404	KO6405M38	38	52	45	26	59	523	5
505405	KO6405M39	39	53.5	45	26.5	59	538	5
505406	KO6405M40	40	54.5	45	27	62	550	5
505407	KO6405M41	41	56	47	28	62	633	5
505408	KO6405M42	42	57	47	28.5	62	652	2
505409	KO6405M43	43	58.5	47	29	62	659	2
505410	KO6405M44	44	59.5	47	29.5	62	657	2
505411	KO6405M45	45	61	47	30	68	734	2
505412	KO6405M46	46	62	47	31	68	791	2
505413	KO6405M47	47	63.5	48	31.5	68	816	2
505414	KO6405M48	48	64.5	45	32	68	800	2
505415	KO6405M50	50	67	48	34	68	880	2
505416	KO6405M52	52	69.5	53	33	72	925	2
505417	KO6405M54	54	72	55	33	72	1040	2
505418	KO6405M55	55	73.5	53	36	72	1006	2
505419	KO6405M56	56	74.5	53	36	72	1092	2
505420	KO6405M57	57	76	53	36	72	1169	2
505421	KO6405M58	58	77	53	36	72	1149	2
505422	KO6405M60	60	79.5	58	39	76	1402	2
505423	KO6405M63	63	83.5	58	39	76	1494	2
505424	KO6405M70	70	92	68	45	84	1785	2

Item Code	Part No.	6405A (inch)	D <sub>1</sub> (mm)	D <sub>2</sub> (mm)	ℓ (mm)	L (mm)	(g)	(pcs.)
505352	KO6405A22	11/16	27	34	13	50	178	5
505353	KO6405A24	3/4	28.5	34	13.5	50	179	5
505354	KO6405A25	25/32	29.5	34	14	50	185	5
505355	KO6405A26	13/16	31	34	14.5	50	185	5
505356	KO6405A28	7/8	32	34	15	50	187	5
505357	KO6405A30	15/16	34.5	34	17	50	200	5
505358	KO6405A32	1	37	34	18	50	222	5
505359	KO6405A34	1. 1/16	38.5	37	19	53	254	5
505360	KO6405A36	1. 1/8	41	38	20	53	292	5
505361	KO6405A38	1. 3/16	42	38	21	55	301	5
505362	KO6405A40	1. 1/4	44.5	40	23	57	351	5
505363	KO6405A42	1. 5/16	46	40	23.5	57	384	5
505364	KO6405A44	1. 3/8	48.5	42	24.5	57	422	5
505365	KO6405A46	1. 7/16	51	42	25.5	59	484	5
505366	KO6405A48	1. 1/2	52	45	26	59	523	5
505367	KO6405A50	1. 9/16	54.5	45	27	59	550	5
505368	KO6405A52	1. 5/8	56	47	28	62	633	5
505369	KO6405A54	1.11/16	58.5	47	29	62	659	2
505370	KO6405A56	1. 3/4	59.5	47	29.5	62	657	2
505371	KO6405A58	1.13/16	62	47	31	68	791	2
505372	KO6405A60	1. 7/8	64.5	45	32	68	892	2
505373	KO6405A62	1.15/16	66	48	32.5	68	870	2
505374	KO6405A64	2	68.5	52	34.5	68	949	2
505375	KO6405A66	2. 1/16	71	54	33	72	983	2
505376	KO6405A68	2. 1/8	72	55	33	72	1040	2
505377	KO6405A70	2. 3/16	74.5	53	36	72	1092	2
505378	KO6405A72	2. 1/4	76	53	36	72	1169	2
505379	KO6405A74	2. 5/16	78.5	53	36	72	1344	2
505380	KO6405A76	2. 3/8	79.5	58	39	76	1402	2
505381	KO6405A78	2. 7/16	82	58	39	76	1420	2
505382	KO6405A80	2. 1/2	84.5	58	39	76	1497	2

6012M-75 

Inhex Sockets, non-impact

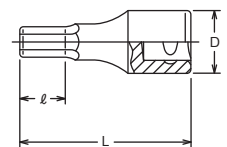

Item Code	Part No.	6012M.75 (mm)	D (mm)	ℓ (mm)	L (mm)	(g)	(pcs.)
505266	KO6012M14	14	35	15.5	75	265	10
505267	KO6012M17	17	35	15.5	75	292	10
505268	KO6012M19	19	35	15.5	75	312	10
505269	KO6012M22	22	38	22.5	75	340	10
505270	KO6012M24	24	38	22.5	75	362	10
505271	KO6012M27	27	38	22.5	75	402	10

# 3/4" Sockets & Accessories

## 6305M · 6305A

12-point Deep Sockets

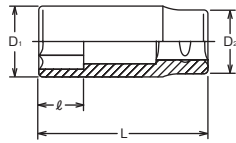

Item Code	Part No.	6305M (mm)	D <sub>1</sub> (mm)	D <sub>2</sub> (mm)	l (mm)	L (mm)	(g)	(pcs.)
505317	KO6305M17	17	26	34	18	90	278	5
505318	KO6305M19	19	28.5	34	20	90	292	5
505319	KO6305M20	20	29.5	34	21	90	334	5
505320	KO6305M21	21	31	34	22	90	343	5
505321	KO6305M22	22	32	34	23	90	347	5
505322	KO6305M23	23	33.5	34	24	90	361	5
505323	KO6305M24	24	34.5	34	25	90	352	5
505324	KO6305M25	25	36	34	26	90	369	5
505325	KO6305M26	26	37	34	27	90	384	5
505326	KO6305M27	27	38.5	37	28	90	425	5
505327	KO6305M28	28	39.5	38	29	90	470	5
505328	KO6305M29	29	41	38	30	90	503	5
505329	KO6305M30	30	42	38	31	90	503	5
505330	KO6305M31	31	43.5	38	32	90	517	5
505331	KO6305M32	32	44.5	40	34	90	544	5
505332	KO6305M33	33	46	40	34	90	557	5
505333	KO6305M34	34	47	40	35	90	570	5
505334	KO6305M35	35	48.5	42	36	90	622	5
505335	KO6305M36	36	49.5	42	37	90	631	2
505336	KO6305M38	38	52	45	39	90	710	2
505337	KO6305M40	40	54.5	45	41	90	742	2
505338	KO6305M41	41	56	47	42	90	802	2
505339	KO6305M42	42	57	47	43	90	829	2
505340	KO6305M43	43	58.5	47	44	90	800	2
505341	KO6305M44	44	59.5	47	45	90	838	2
505342	KO6305M46	46	62	47	47	90	906	2
505343	KO6305M50	50	67	48	51	90	1005	2
505344	KO6305M53	53	71	54	49	100	1338	2
505345	KO6305M54	54	72	55	49	100	1351	2
505346	KO6305M55	55	73.5	53	52	100	1388	2
505347	KO6305M57	57	76	53	52	100	1467	2
505348	KO6305M58	58	77	53	52	100	1480	2
505349	KO6305M60	60	79.5	58	55	100	1626	2
505350	KO6305M63	63	83.5	58	55	100	1740	2

Item Code	Part No.	6305A (inch)	D <sub>1</sub> (mm)	D <sub>2</sub> (mm)	l (mm)	L (mm)	(g)	(pcs.)
505291	KO6305A24	3/4	28.5	34	20	90	292	5
505292	KO6305A26	13/16	31	34	22	90	343	5
505293	KO6305A28	7/8	32	34	23	90	347	5
505294	KO6305A30	15/16	34.5	34	25	90	352	5
505295	KO6305A32	1	37	34	27	90	384	5
505296	KO6305A34	1. 1/16	38.5	37	28	90	425	5
505297	KO6305A36	1. 1/8	41	38	30	90	503	5
505298	KO6305A38	1. 3/16	42	38	31	90	503	5
505299	KO6305A40	1. 1/4	44.5	40	34	90	544	5
505300	KO6305A42	1. 5/16	46	40	34	90	557	5
505301	KO6305A44	1. 3/8	48.5	42	36	90	622	5
505302	KO6305A46	1. 7/16	51	42	38	90	656	2
505303	KO6305A48	1. 1/2	52	45	39	90	710	2
505304	KO6305A50	1. 9/16	54.5	45	41	90	742	2
505305	KO6305A52	1. 5/8	56	47	42	90	802	2
505306	KO6305A54	1.11/16	58.5	47	44	90	831	2
505307	KO6305A56	1. 3/4	59.5	47	45	90	838	2
505308	KO6305A64	2	68.5	52	52	90	1061	2
505309	KO6305A66	2. 1/16	71	54	49	100	1338	2
505310	KO6305A68	2. 1/8	72	55	49	100	1351	2
505311	KO6305A70	2. 3/16	74.5	53	52	100	1389	2
505312	KO6305A72	2. 1/4	76	53	52	100	1467	2
505313	KO6305A74	2. 5/16	78.5	53	52	100	1787	2
505314	KO6305A76	2. 3/8	79.5	58	55	100	1626	2
505315	KO6305A78	2. 7/16	82	58	55	100	1715	2
505316	KO6305A80	2. 1/2	84.5	58	69	100	1640	2

## 6749 Reversible Ratchet



\* Renewal Kits → 6749RK



## 6749-1000 Reversible Ratchet



\* Renewal Kits → 6749RK

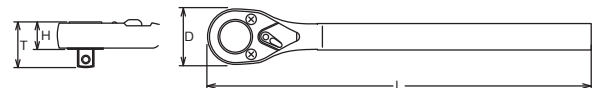

Item Code	Part No.	D (mm)	T (mm)	H (mm)	L (mm)	(g)	(pcs.)
505429	KO6749550	68	49.6	29.6	565	2800	1
505428	KO67491000	68	49.6	29.6	1000	3600	1

## 6755 Ratchet Adaptor



\* Renewal Kits → 6755RK

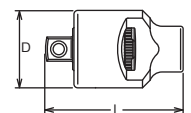

Item Code	Part No.	D (mm)	L (mm)	(g)	(pcs.)
505434	KO6755	62	97	1162	1

## 6760 Extension Bars



Item Code	Part No.	D (mm)	L (mm)	(g)	(pcs.)
505436	KO6760075	35	75	335	10
505437	KO6760200	35	200	815	1
505438	KO6760400	35	400	1585	1

## 6768 Hinge Handle

\* Renewal Kits → 6768RK

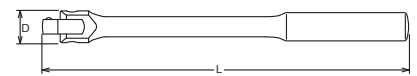

Item Code	Part No.	D (mm)	L (mm)	(g)	(pcs.)
505439	KO6768	42	450	1715	1
505441	KO6768600	42	600	2800	1
505440	KO67681000	42	1000	3400	1

**Kokoen**

# 3/4" Sockets & Accessories

**6785** T-Handle

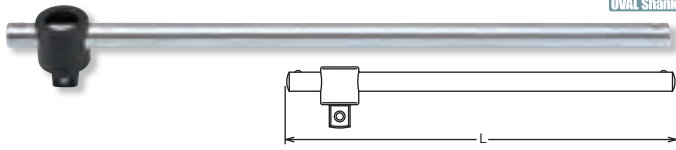

Item Code	Part No.	L (mm)	(g)	(pcs.)
505445	KO6785	500	1542	1

**6788** L-Handle

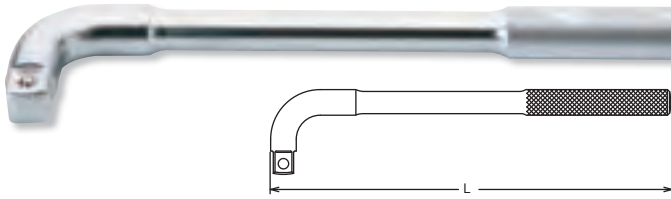

Item Code	Part No.	L (mm)	(g)	(pcs.)
505446	KO6788	330	1715	1

**6770** Universal Joint



Item Code	Part No.	L (mm)	(g)	(pcs.)
505443	KO6770	105	478	2

**6644A** Reducer Warranty 668Nm



Item Code	Part No.	(sq.)	(sq.)	L (mm)	(g)	(pcs.)
505425	KO6644A	3/4"	1/2"	47	136	5

**6688A** Adaptor



Item Code	Part No.	(sq.)	(sq.)	L (mm)	(g)	(pcs.)
505426	KO6688A	3/4"	1"	60	285	5

**6101** Drag Link Socket for Slotted Heads



Item Code	Part No.	(3/4")	TxW (mm)	D (mm)	L (mm)	(g)	(pcs.)
505275	KO6101	3/4"	6.4x33.5	35	50	205	10

**6201M** Socket Sets

**6201A**



16 Piece Set METAL CASE:W580xH200xT85mm  $\Delta$  = 17,300g

Item Code	Part No.	Sockets	Accessories
505278	KO6201M	6405M 12-pt. Sockets 22, 24, 27, 30, 32, 36,41, 46, 50, 55, 60mm	6749 6760-200 6760-400 6768 6785

18 Piece Set METAL CASE:W580xH200xT85mm  $\Delta$  = 17,600g

Item Code	Part No.	Sockets	Accessories
505276	KO6201A	6405A 12-pt. Sockets 7/8, 15/16, 1.1/16, 1.1/8, 1.1/4, 1.5/16, 1.7/16, 1.1/2, 1.5/8, 1.11/16, 1.13/16, 1.7/8, 2"	6749 6760-200 6760-400 6768 6785

**6212M** Socket Sets



12 Piece Set METAL CASE:W580xH124xT70mm  $\Delta$  = 11,000g

Item Code	Part No.	Sockets	Accessories
505279^	KO6212M	6405M 12-pt. Sockets 22, 24, 27, 30, 32, 36,41, 46, 50mm	6749 6760-200 6785

**Kokem**









# 3/4" Sockets & Accessories

## 6260M 6260A

Socket Sets

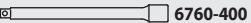

20 Piece Set  
METAL CASE:W580xH200xT85mm  $\Delta = 15,800g$







Item Code	Part No.	Sockets	Accessories
505285 <sup>^</sup>	KO6260M	 <b>6405M</b> 12-pt. Sockets 21, 23, 26, 29, 31, 32,34, 35, 36, 38, 41, 46, 50mm	 6749  6760-75  6760-200  6760-400
		 <b>6101 Drag Link Socket</b>	 6770  6785

## 6290M 6290A

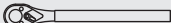



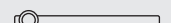

Socket Sets







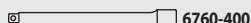

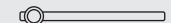
23 Piece Set  
METAL CASE:W635xH215xT85mm  $\Delta = 20,000g$

Item Code	Part No.	Sockets	Accessories
505287 <sup>^</sup>	KO6290M	 <b>6405M</b> 12-pt. Sockets 21, 23, 26, 29, 31, 32,34, 35, 36, 38, 41, 46, 50, 54, 58, 63mm	 6749  6760-75  6760-200  6760-400
		 <b>6101 Drag Link Socket</b>	 6770  6785

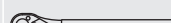
25 Piece Set  
METAL CASE:W580xH200xT85mm  $\Delta = 19,000g$

Item Code	Part No.	Sockets	Accessories
505284 <sup>^</sup>	KO6260A	 <b>6405A</b> 12-pt. Sockets 15/16, 31/32, 1, 1.1/16, 1.1/8, 1.3/16, 1.1/4, 1.5/16, 1.3/8, 1.7/16, 1.1/2, 1.9/16, 1.5/8, 1.11/16, 1.3/4, 1.13/16, 1.7/8, 2"	 6749  6760-75  6760-200  6760-400
		 <b>6101 Drag Link Socket</b>	 6770  6785

29 Piece Set  
METAL CASE:W635xH215xT85mm  $\Delta = 23,000g$

Item Code	Part No.	Sockets	Accessories
505286 <sup>^</sup>	KO6290A	 <b>6405A</b> 12-pt. Sockets 7/8, 15/16, 31/32, 1, 1.1/16, 1.1/8, 1.3/16, 1.1/4, 1.5/16, 1.3/8, 1.7/16, 1.1/2, 1.9/16, 1.5/8, 1.11/16, 1.3/4, 1.13/16, 1.7/8, 2, 2.1/8, 2.3/16, 2.1/4"	 6749  6760-75  6760-200  6760-400
		 <b>6101 Drag Link Socket</b>	 6770  6785

# 1" Sockets & Accessories

## 8405M · 8405A

12-point Sockets

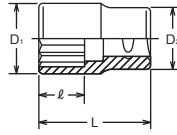

Item Code	Part No.	8405M (mm)	D <sub>1</sub> (mm)	D <sub>2</sub> (mm)	ℓ (mm)	L (mm)	(g)	(pce.)
505484	KO8405M27	27	40.5	44	19	60	362	1
505485	KO8405M32	32	46.5	45	23	65	455	1
505486	KO8405M33	33	48	46	23.5	65	485	1
505487	KO8405M35	35	50.5	48	24.5	65	536	1
505488	KO8405M36	36	51.5	48	25	65	600	1
505489	KO8405M38	38	54	50	26	65	624	1
505490	KO8405M40	40	56.5	53	27	65	686	1
505491	KO8405M41	41	58	53	28	68	747	1
505492	KO8405M46	46	64	53	31	72	928	1
505493	KO8405M50	50	69	53	34	72	943	1
505494	KO8405M54	54	74	55	37	72	1016	1
505495	KO8405M55	55	75.5	53	42	77	1167	1
505496	KO8405M58	58	79	53	41	77	1200	1
505497	KO8405M60	60	81.5	58	46	82	1440	1
505498	KO8405M63	63	85.5	58	45	82	1470	1
505499	KO8405M65	65	88	63	49	86	1683	1
505500	KO8405M67	67	90.5	63	49	86	1840	1
505501	KO8405M70	70	94	68	50	88	1963	1
505502	KO8405M71	71	95.5	68	50	88	2200	1
505503	KO8405M75	75	100.5	73	53	90	2204	1
505504	KO8405M80	80	106.5	75	58	95	2550	1

Item Code	Part No.	8405A (inch)	D <sub>1</sub> (mm)	D <sub>2</sub> (mm)	ℓ (mm)	L (mm)	(g)	(pce.)
505455	KO8405A34	1. 1/16	40.5	44	19	60	365	1
505456	KO8405A40	1. 1/4	46.5	45	23	65	455	1
505457	KO8405A42	1. 5/16	48	46	23.5	65	485	1
505458	KO8405A44	1. 3/8	50.5	48	24.5	65	536	1
505459	KO8405A46	1. 7/16	53	50	25.5	65	607	1
505460	KO8405A48	1. 1/2	54	50	26	65	624	1
505461	KO8405A50	1. 9/16	56.5	53	27	65	686	1
505462	KO8405A52	1. 5/8	58	53	28	68	747	1
505463	KO8405A54	1.11/16	60.5	53	29	68	830	1
505464	KO8405A56	1. 3/4	61.5	53	29.5	68	807	1
505465	KO8405A58	1.13/16	64	53	31	72	928	1
505466	KO8405A60	1. 7/8	66.5	53	32	72	936	1
505467	KO8405A64	2	70.5	53	37	72	976	1
505468	KO8405A66	2. 1/16	73	54	37	72	1027	1
505469	KO8405A68	2. 1/8	74	55	37	72	1016	1
505470	KO8405A70	2. 3/16	76.5	53	41	77	1192	1
505471	KO8405A72	2. 1/4	78	53	41	77	1177	1
505472	KO8405A74	2. 5/16	80.5	53	41	77	1292	1
505473	KO8405A76	2. 3/8	81.5	58	46	82	1440	1
505474	KO8405A78	2. 7/16	84	58	45	82	1495	1
505475	KO8405A80	2. 1/2	86.5	58	45	82	1497	1
505476	KO8405A82	2. 9/16	88	63	49	86	1683	1
505477	KO8405A84	2. 5/8	90.5	63	49	86	1840	1
505478	KO8405A86	2.11/16	91.5	63	49	86	1800	1
505479	KO8405A88	2. 3/4	94	68	50	88	1963	1
505480	KO8405A90	2.13/16	96.5	68	50	88	2035	1
505481	KO8405A92	2. 7/8	98	70	50	88	2100	1
505482	KO8405A94	2.15/16	100.5	73	53	90	2204	1
505483	KO8405A96	3	103	75	53	90	2406	1
505452	KO8405A100	3. 1/8	106.5	75	58	95	2550	1
505453	KO8405A104	3. 1/4	110.5	78	57	95	2730	1
505454	KO8405A112	3. 1/2	119	80	59	100	3420	1

## 8760

Extension Bars

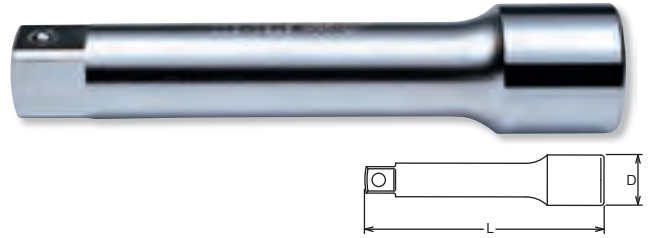

Item Code	Part No.	D (mm)	L (mm)	(g)	(pce.)
505509	KO8760200	44	200	1300	1
505510	KO8760400	44	400	2570	1

## 8770

Universal Joint



Item Code	Part No.	L (mm)	(g)	(pce.)
505513	KO8770	143	1170	1

## 8866A

Reducer Warranty 1850Nm



Item Code	Part No.	(mm)	(mm)	L (mm)	(g)	(pce.)
505516	KO8866A	1"	3/4"	60	338	5

⚠ Adapting down from bigger square drive to smaller square drive may lead to excessive torque and possibly cause breakage.

## 8749

Reversible Ratchet

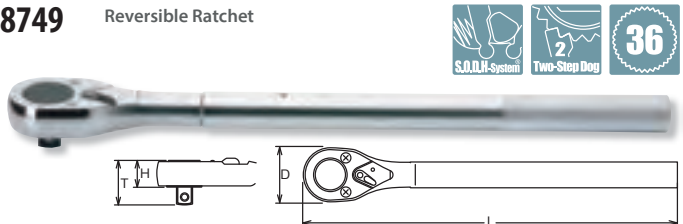

\* Renewal Kits → 8749RK → P277

Item Code	Part No.	D (mm)	T (mm)	H (mm)	L (mm)	(g)	(pce.)
505505	KO8749	70	62.2	36.2	800	4090	1



# 1" Sockets & Accessories

**8768** Hinge Handle

\* Renewal Kits → 8768RK

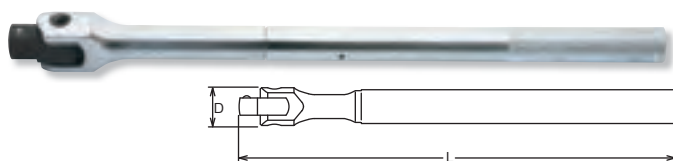

Item Code	Part No.	D (mm)	L (mm)	(g)	(pce.)
505511	KO8768	55	600	3190	1

**8785** T-Handle

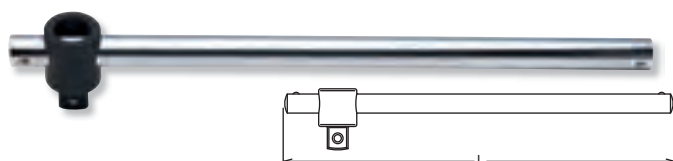

Item Code	Part No.	L (mm)	(g)	(pce.)
505515	KO8785	550	3190	1

**8200M** Socket Sets

**8200A**



12 Piece Set  
METAL CASE:W600xH150xT110mm  $\Delta$  = 18,600g

Item Code	Part No.	Sockets	Accessories
505448	KO8200M	8405M 12-pt. Sockets 35, 38, 41, 46, 50, 54, 58, 63mm	8760-200 8760-400 8770 8785

12 Piece Set  
METAL CASE:W600xH150xT110mm  $\Delta$  = 18,600g

Item Code	Part No.	Sockets	Accessories
505447 <sup>^</sup>	KO8200A	8405A 12-pt. Sockets 1.7/16, 1.1/2, 1.5/8, 1.13/16, 2, 2.1/8, 2.1/4, 2.1/2"	8760-200 8760-400 8770 8785



**8225M** Socket Set



15 Piece Set  
METAL CASE:W620xH217xT97mm  $\Delta$  = 27,000g

Item Code	Part No.	Sockets	Accessories
505449	KO8225M	8405M 12-pt. Sockets 32, 33, 36, 41, 46, 50, 55, 60, 65, 70, 75, 80mm	8749 8760-200 8760-400

**8290M** Socket Set



13 Piece Set  
METAL CASE:W635xH150xT100mm  $\Delta$  = 22,800g

Item Code	Part No.	Sockets	Accessories
505451	KO8290A	8405A 12-pt. Sockets 1.7/16, 1.1/2, 1.5/8, 1.13/16, 2, 2.1/8, 2.1/4, 2.1/2"	8749 8760-200 8760-400 8770 8785

**Koken**

# 1/4" Impact Sockets & Accessories

12400M · 12400A

6-point Sockets

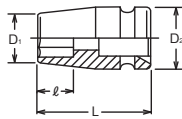

Item Code	Part No.	12400M (mm)	D <sub>1</sub> (mm)	D <sub>2</sub> (mm)	ℓ (mm)	L (mm)	(g)	(pcs.)	Ⓢ
503653 <sup>△</sup>	KO12400M06	6	10	13	5	23	14	10	*1
503654 <sup>△</sup>	KO12400M07	7	11.3	13	5	23	14	10	*1
503655 <sup>△</sup>	KO12400M08	8	12.5	13	6	23	14	10	*1
503656 <sup>△</sup>	KO12400M10	10	15	13	7	23	15	10	*1
503657 <sup>△</sup>	KO12400M12	12	17.5	13	8	23	19	10	*1

Item Code	Part No.	12400A (inch)	D <sub>1</sub> (mm)	D <sub>2</sub> (mm)	ℓ (mm)	L (mm)	(g)	(pcs.)	Ⓢ
503652 <sup>△</sup>	KO12400A08	1/4	10	13	5	23	14	10	*1

\*1 Pin/O-Ring=1200A/B

12770 Universal Joint

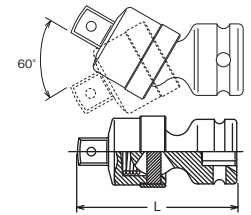

Item Code	Part No.	L (mm)	(g)	(pcs.)	Ⓢ
503661 <sup>△</sup>	KO12770P	39	30	10	*1

\*1 Pin/O-Ring=1200A/B

## FLAT DRIVE<sup>®</sup>

Flat drive is designed to guarantee a flat surface contact between the socket and the bolt/nut. The Flat contact reduces wear and allows to transmit a higher torque value. The Flat Drive System is also used for the square drive end as well as the hexagonal or bi-hexagonal openings of the socket

# 3/8" Impact Sockets & Accessories

13400M · 13400A

6-point Sockets

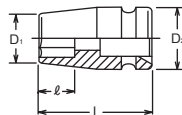

Item Code	Part No.	13400M (mm)	D <sub>1</sub> (mm)	D <sub>2</sub> (mm)	ℓ (mm)	L (mm)	(g)	(pcs.)	Ⓢ
503711 <sup>△</sup>	KO13400M06	6	10.8	19	5	32	40	10	*1
503712 <sup>△</sup>	KO13400M07	7	12	19	5	32	40	10	*1
503713 <sup>△</sup>	KO13400M08	8	13.3	19	6	32	40	10	*1
503714 <sup>△</sup>	KO13400M09	9	14.5	19	7	32	40	10	*1
503715 <sup>△</sup>	KO13400M10	10	15.8	19	7	32	40	10	*1
503716 <sup>△</sup>	KO13400M11	11	17	19	8	32	41	10	*1
503717 <sup>△</sup>	KO13400M12	12	18.3	19	9	32	43	10	*1
503718 <sup>△</sup>	KO13400M13	13	19.5	22	10	32	56	10	*2
503719 <sup>△</sup>	KO13400M14	14	20.8	22	10	32	56	10	*2
503720 <sup>△</sup>	KO13400M15	15	22	22	11	32	56	10	*2
503721 <sup>△</sup>	KO13400M16	16	23.3	22	11	32	57	10	*2
503722 <sup>△</sup>	KO13400M17	17	24.5	22	12	32	60	10	*2
503723 <sup>△</sup>	KO13400M18	18	25.8	22	12	32	62	10	*2
503724 <sup>△</sup>	KO13400M19	19	27	22	12	32	67	10	*2
503725 <sup>△</sup>	KO13400M21	21	29.5	22	12	32	71	10	*2
503726 <sup>△</sup>	KO13400M22	22	30.8	22	13	32	72	10	*2
503727 <sup>△</sup>	KO13400M23	23	32	22	13	32	75	10	*2

13300M · 13300A

6-point Sockets, deep

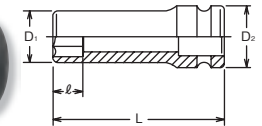

Item Code	Part No.	13300M (mm)	D <sub>1</sub> (mm)	D <sub>2</sub> (mm)	ℓ (mm)	L (mm)	(g)	(pcs.)	Ⓢ
503681 <sup>△</sup>	KO13300M06	6	10.8	19	6	80	77	10	*1
503682 <sup>△</sup>	KO13300M07	7	12	19	7	80	82	10	*1
503683 <sup>△</sup>	KO13300M08	8	13.3	19	8	80	82	10	*1
503684 <sup>△</sup>	KO13300M09	9	14.5	19	9	80	88	10	*1
503685 <sup>△</sup>	KO13300M10	10	15.8	19	10	80	94	10	*1
503686 <sup>△</sup>	KO13300M11	11	17	19	11	80	110	10	*1
503687 <sup>△</sup>	KO13300M12	12	18.3	19	12	80	111	10	*1
503688 <sup>△</sup>	KO13300M13	13	19.5	22	13	80	138	10	*2
503689 <sup>△</sup>	KO13300M14	14	20.8	22	14	80	148	10	*2
503690 <sup>△</sup>	KO13300M15	15	22	22	15	80	157	10	*2
503691 <sup>△</sup>	KO13300M16	16	23.3	22	16	80	156	10	*2
503692 <sup>△</sup>	KO13300M17	17	24.5	22	17	80	168	10	*2
503693 <sup>△</sup>	KO13300M18	18	25.8	22	18	80	190	10	*2
503694 <sup>△</sup>	KO13300M19	19	27	22	19	80	192	10	*2
503695 <sup>△</sup>	KO13300M20	20	28.3	22	20	80	224	10	*2
503696 <sup>△</sup>	KO13300M21	21	29.5	22	21	80	226	10	*2
503697 <sup>△</sup>	KO13300M22	22	30.8	22	22	80	231	10	*2

Item Code	Part No.	13300A (inch)	D <sub>1</sub> (mm)	D <sub>2</sub> (mm)	ℓ (mm)	L (mm)	(g)	(pcs.)	Ⓢ
503670 <sup>△</sup>	KO13300A08	1/4	10.8	19	6	80	77	10	*1
503671 <sup>△</sup>	KO13300A10	5/16	13.3	19	8	80	82	10	*1
503672 <sup>△</sup>	KO13300A12	3/8	15.8	19	10	80	94	10	*1
503673 <sup>△</sup>	KO13300A14	7/16	17	19	11	80	110	10	*1
503674 <sup>△</sup>	KO13300A16	1/2	19.5	22	13	80	138	10	*2
503675 <sup>△</sup>	KO13300A18	9/16	20.8	22	14	80	148	10	*2
503676 <sup>△</sup>	KO13300A20	5/8	23.3	22	16	80	156	10	*2
503677 <sup>△</sup>	KO13300A22	11/16	24.5	22	17	80	168	10	*2
503678 <sup>△</sup>	KO13300A24	3/4	27	22	19	80	192	10	*2
503679 <sup>△</sup>	KO13300A26	13/16	29.5	22	21	80	226	10	*2
503680 <sup>△</sup>	KO13300A28	7/8	30.8	22	22	80	231	10	*2

\*1 C-Ring=1301C, Pin/O-Ring=1301A/B

\*2 C-Ring=1302C, Pin/O-Ring=1302A/B

\*1 C-Ring=1301C, Pin/O-Ring=1301A/B

\*2 C-Ring=1302C, Pin/O-Ring=1302A/B

# 3/8" Impact Sockets & Accessories

## 13400MG 6-point Sockets with Magnet

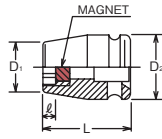

Item Code	Part No.	13400MG (mm)	D <sub>1</sub> (mm)	D <sub>2</sub> (mm)	ℓ (mm)	L (mm)	(g)	(pcs.)	
503728 <sup>^</sup>	KO13400MG10	10	15.8	19	4.2	32	49	10	*1

\*1 C-Ring=1301C, Pin/O-Ring=1301A/B

## 1301C 1302C C-Ring

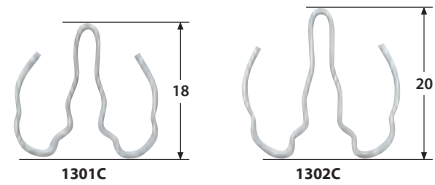

Item Code	Part No.		Opening (mm)	(pcs.)
503665 <sup>^</sup>	KO1301C	3/8"	≤ 12	100
503668 <sup>^</sup>	KO1302C	3/8"	> 12	100

## 13760 Extension Bars

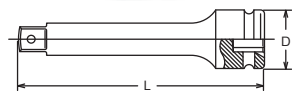

Item Code	Part No.	D (mm)	L (mm)	(g)	(pcs.)	
503731 <sup>^</sup>	KO13760075	22	75	95	10	*1
503733 <sup>^</sup>	KO13760125	22	125	141	10	*1
503735 <sup>^</sup>	KO13760250	22	250	260	10	*1

\*1 C-Ring=1302C, Pin/O-Ring=1302A/B

## 1301A 1302A Spare Pin

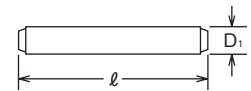

Item Code	Part No.		Opening (mm)	D <sub>1</sub> (mm)	ℓ (mm)	(pcs.)
503663	KO1301A	3/8"	≤ 12	2.5	14.5	100
503666	KO1302A	3/8"	> 12	2.5	17.5	100

## 1301B 1302B Spare Ring



Item Code	Part No.		Opening (mm)	D <sub>2</sub> (mm)	D <sub>3</sub> (mm)	(pcs.)
503664	KO1301B	3/8"	≤ 12	3.5	13	100
503667	KO1302B	3/8"	> 12	3.5	16	100

## 13770 Universal Joint

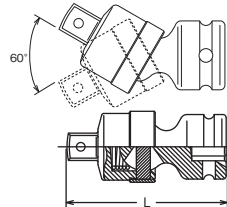

Item Code	Part No.	L (mm)	(g)	(pcs.)	
503736 <sup>^</sup>	KO13770	56	110	10	*1

\*1 C-Ring=1302C, Pin/O-Ring=1302A/B

## 13344A Adaptor

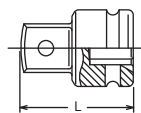

Item Code	Part No.			L (mm)	(g)	(pcs.)	
503699	KO13344A	3/8"	1/2"	32.5	53	10	*1

\*1 C-Ring=1302C, Pin/O-Ring=1302A/B

## 13241M Socket Set



11 Piece Set  
METAL CASE:W240xH30xT35mm = 850g

Item Code	Part No.		Sockets
503669 <sup>^</sup>	KO13241M		13400M 6-pt. Sockets 9, 10, 11, 12, 13, 14, 15, 16, 17, 18, 19

**Korfen**

# 1/2" Impact Sockets & Accessories

## 14400M · 14400A

6-point Sockets

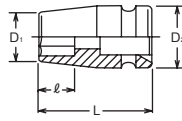

Item Code	Part No.	14400M (mm)	D <sub>1</sub> (mm)	D <sub>2</sub> (mm)	ℓ (mm)	L (mm)	(g)	(pcs.)	
503838	KO14400M06	6	12	25	5	38	77	10	*1
503839	KO14400M08	8	14.5	25	6	38	85	10	*1
503840	KO14400M09	9	15.7	25	7	38	85	10	*1
503841	KO14400M10	10	17	25	7	38	85	10	*1
503842	KO14400M11	11	18.2	25	8	38	85	10	*1
503843	KO14400M12	12	19.5	25	9	38	85	10	*1
503844	KO14400M13	13	20.7	25	10	38	85	10	*1
503845	KO14400M14	14	22	25	10	38	85	10	*1
503846	KO14400M15	15	23.2	30	11	38	130	10	*2
503847	KO14400M16	16	24.5	30	11	38	130	10	*2
503848	KO14400M17	17	25.7	30	12	38	130	10	*2
503849	KO14400M18	18	27	30	13	38	130	10	*2
503850	KO14400M19	19	28.2	30	13	38	125	10	*2
503851	KO14400M20	20	29.5	30	13	38	127	10	*2
503852	KO14400M21	21	30.7	30	14	38	120	10	*2
503853	KO14400M22	22	32	30	14	38	130	10	*2
503854	KO14400M23	23	33.2	30	14	38	130	10	*2
503855	KO14400M24	24	34.5	30	14	38	135	10	*2
503856	KO14400M26	26	37	30	14	38	160	10	*2
503857	KO14400M27	27	38.2	30	16	40	160	10	*2
503858	KO14400M28	28	39.5	30	16	40	170	10	*2
503859	KO14400M29	29	40.7	30	17	42	190	10	*2
503860	KO14400M30	30	42	30	17	42	190	10	*2
503861	KO14400M32	32	44.5	30	18	42	216	10	*2
503862	KO14400M36	36	49.5	30	20	46	285	5	*2
503863	KO14400M41	41	55.7	30	21	55	411	2	*2

\*1 C-Ring=1401C, Pin/O-Ring=1401A/B  
\*2 C-Ring=1402C, Pin/O-Ring=1402A/B

## 14300M · 14300A

6-point Deep Sockets

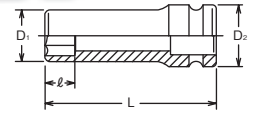

Item Code	Part No.	14300M (mm)	D <sub>1</sub> (mm)	D <sub>2</sub> (mm)	ℓ (mm)	L (mm)	(g)	(pcs.)	
503792	KO14300M08	8	14.5	25	8	80	137	10	*1
503793	KO14300M09	9	15.7	25	9	80	138	10	*1
503794	KO14300M10	10	17	25	10	80	140	10	*1
503795	KO14300M11	11	18.2	25	11	80	156	10	*1
503796	KO14300M12	12	19.5	25	12	80	162	10	*1
503797	KO14300M13	13	20.7	25	13	80	162	10	*1
503798	KO14300M14	14	22	25	14	80	174	10	*1
503799	KO14300M15	15	23.2	30	15	80	220	10	*2
503800	KO14300M16	16	24.5	30	16	80	232	10	*2
503801	KO14300M17	17	25.7	30	17	80	232	10	*2
503802	KO14300M18	18	27	30	18	80	232	10	*2
503803	KO14300M19	19	28.2	30	19	80	259	10	*2
503804	KO14300M21	21	30.7	30	21	80	265	10	*2
503805	KO14300M22	22	32	30	22	85	290	10	*2
503806	KO14300M23	23	33.2	30	23	85	300	10	*2
503807	KO14300M24	24	34.5	30	24	85	329	10	*2
503808	KO14300M26	26	37	30	26	85	350	10	*2
503809	KO14300M27	27	38.2	30	27	85	385	10	*2
503810	KO14300M29	29	40.7	30	29	85	416	10	*2
503811	KO14300M30	30	42	30	30	85	457	10	*2
503812	KO14300M31	31	43.2	30	31	85	505	10	*2
503813	KO14300M32	32	44.5	30	32	85	542	10	*2
503814	KO14300M34	34	47	30	33	85	570	2	*2
503815	KO14300M36	36	49.5	30	36	85	540	2	*2
503816	KO14300M41	41	55.7	30	38	85	625	2	*2

\*1 C-Ring=1401C, Pin/O-Ring=1401A/B  
\*2 C-Ring=1402C, Pin/O-Ring=1402A/B

Item Code	Part No.	14400A (inch)	D <sub>1</sub> (mm)	D <sub>2</sub> (mm)	ℓ (mm)	L (mm)	(g)	(pcs.)	
503821	KO14400A10	5/16	14.5	25	6	38	85	10	*1
503822	KO14400A12	3/8	17	25	7	38	85	10	*1
503823	KO14400A14	7/16	18.2	25	8	38	85	10	*1
503824	KO14400A16	1/2	20.7	25	10	38	85	10	*1
503825	KO14400A18	9/16	22	25	10	38	85	10	*1
503826	KO14400A19	19/32	23.2	30	11	38	130	10	*2
503827	KO14400A20	5/8	24.5	30	11	38	130	10	*2
503828	KO14400A22	11/16	25.7	30	12	38	130	10	*2
503829	KO14400A24	3/4	28.2	30	13	38	125	10	*2
503830	KO14400A26	13/16	30.7	30	14	38	120	10	*2
503831	KO14400A28	7/8	32	30	14	38	130	10	*2
503832	KO14400A30	15/16	34.5	30	14	38	135	10	*2
503833	KO14400A32	1	35.7	30	14	38	135	10	*2
503834	KO14400A34	1. 1/16	38.2	30	16	40	160	10	*2
503835	KO14400A36	1. 1/8	40.7	30	17	42	190	10	*2
503836	KO14400A38	1. 3/16	42	30	17	42	190	10	*2
503837	KO14400A40	1. 1/4	44.5	30	18	42	216	10	*2

\*1 C-Ring=1401C, Pin/O-Ring=1401A/B  
\*2 C-Ring=1402C, Pin/O-Ring=1402A/B

Item Code	Part No.	14300A (inch)	D <sub>1</sub> (mm)	D <sub>2</sub> (mm)	ℓ (mm)	L (mm)	(g)	(pcs.)	
503777	KO14300A10	5/16	14.5	25	8	80	137	10	*1
503778	KO14300A12	3/8	17	25	10	80	140	10	*1
503779	KO14300A14	7/16	18.2	25	11	80	156	10	*1
503780	KO14300A16	1/2	20.7	25	13	80	162	10	*1
503781	KO14300A18	9/16	22	25	14	80	174	10	*1
503782	KO14300A20	5/8	24.5	30	16	80	232	10	*2
503783	KO14300A22	11/16	25.7	30	17	80	232	10	*2
503784	KO14300A24	3/4	28.2	30	19	80	259	10	*2
503785	KO14300A26	13/16	30.7	30	21	80	265	10	*2
503786	KO14300A28	7/8	32	30	22	85	290	10	*2
503787	KO14300A30	15/16	34.5	30	24	85	329	10	*2
503788	KO14300A32	1	35.7	30	25	85	345	10	*2
503789	KO14300A34	1. 1/16	38.2	30	27	85	385	10	*2
503790	KO14300A36	1. 1/8	40.7	30	29	85	416	10	*2
503791	KO14300A40	1. 1/4	44.5	30	32	85	542	10	*2

\*1 C-Ring=1401C, Pin/O-Ring=1401A/B  
\*2 C-Ring=1402C, Pin/O-Ring=1402A/B

## RS14401M/10

Thin-walled Socket Set on Rail



Item Code	Part No.	Socket Set	(g)
505542	KORS14401M/10	RS14401M: 10 Piece Set/Rail 300mm 10, 12, 13, 14, 17, 19, 21, 22, 24, 27mm	1,010

# 1/2" Impact Sockets & Accessories

## 14301M 6-point Deep Sockets, Thin-walled

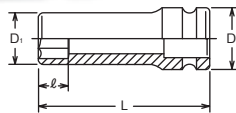

Item Code	Part No.	14301M (mm)	D <sub>1</sub> (mm)	D <sub>2</sub> (mm)	l (mm)	L (mm)	(g)	(pcs.)	
503817 <sup>^</sup>	KO14301M17	17	24.2	29	17	80	182	10	*2

\*2 C-Ring=1402C, Pin/O-Ring=1402A/B

## RS14012M60/10 Inhex Socket Set on Rail



Item Code	Part No.	Socket Set	(g)
505541	KORS14012M60/10	RS14012A: 10 Piece Set/Rail 300mm 4, 5, 6, 7, 8, 10, 12, 14, 17, 19mm	1,300

## 14105 Bit Holder

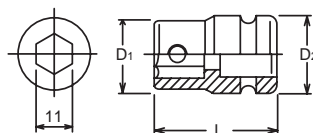

Item Code	Part No.	D <sub>1</sub> (mm)	D <sub>2</sub> (mm)	L (mm)	(g)	(pcs.)	
503759 <sup>^</sup>	KO14105	22	30	38	126	10	*1

\*1 C-Ring=1402C, Pin/O-Ring=1402A/B

Replacement Screw : M5x6, 2.5mm

## 107-11 Bits for Inhex Screws

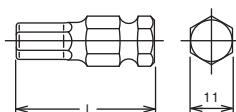

Item Code	Part No.	107.11 (mm)	L (mm)	(g)	(pcs.)
503626	KO10711M05	5	35	16	10
503627	KO10711M06	6	35	18	10
503628	KO10711M08	8	35	20	10
503629	KO10711M10	10	35	26	10
503630	KO10711M19	19	35	56	10

## 14203M Inhex Bit Set



10 Piece Set  
METAL CASE: W215xH80xT47mm  = 900g

Item Code	Part No.	Bits	Bit Holder
503771	KO14203M	107.11 Hex Bits 5, 6, 8, 10	14105 Bit Holder
		107.16 Hex Bits 12, 14, 17, 19	14106 Bit Holder

## 14760 Extension Bars

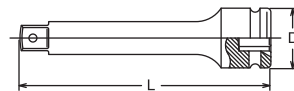

Item Code	Part No.	D (mm)	L (mm)	(g)	(pce.)	
503874 <sup>^</sup>	KO14760050	30	50	150	1	*1
503875 <sup>^</sup>	KO14760075	30	75	188	1	*1
503876 <sup>^</sup>	KO14760125	30	125	275	1	*1
503877 <sup>^</sup>	KO14760150	30	150	300	1	*1
503878 <sup>^</sup>	KO14760225	30	225	440	1	*1
503879 <sup>^</sup>	KO14760250	30	250	480	1	*1

\*1 C-Ring=1401C, Pin/O-Ring=1401A/B

## 14770 Universal Joint

### 14770-B Universal Joint - Ball Type

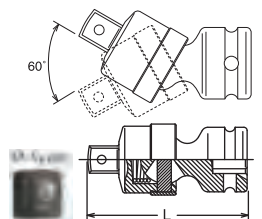

Item Code	Part No.	L (mm)	(g)	(pcs.)	
503880	KO14770	74	210	5	*1
503881	KO14770-B	74	210	5	*1

\*1 C-Ring=1401C, Pin/O-Ring=1401A/B

## 14433A Reducer

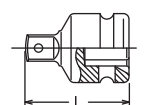

Item Code	Part No.	□ (sq.)	□ (sq.)	L (mm)	(g)	(pcs.)	
503868	KO14433A	1/2"	3/8"	36	68	10	*1
503869 <sup>^</sup>	KO14433A-B	1/2"	3/8"	36	68	10	*1

\*1 C-Ring=1401C, Pin/O-Ring=1401A/B

Adapting down to a smaller square drive may lead to excessive torque load and possibly cause breakage. Always stay within limit torque of the smaller square drive.

# 1/2" Impact Sockets & Accessories

**14466A** Adaptor

**14466A-B** Adaptor - Ball Type

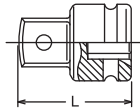

Item Code	Part No.	□ (sq.)	□ (sq.)	L (mm)	⚖ (g)	📦 (pcs.)	⚙
503871	KO14466A	1/2"	3/4"	44	146	10	*1
503782	KO14466A-B	1/2"	3/4"	44	146	10	*1

\*1 C-Ring=1401C, Pin/O-Ring=1401A/B

**14118M · 14118A** Wheel Nut Sockets, Double Ended

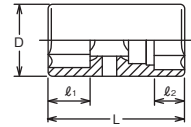

Item Code	Part No.	14118M (mm)	□	D (mm)	l1 (mm)	l2 (mm)	L (mm)	⚖ (g)	📦 (pcs.)
503761	KO14118M1921	19x21		31	17.5	13	57	177	10
503762	KO14118M1922	19x22	1/2"	31	17.5	15	57	187	10
503763	KO14118M2122	21x22		31	17.5	15	57	185	10

Item Code	Part No.	14118A (inch)	□	D (mm)	l1 (mm)	l2 (mm)	L (mm)	⚖ (g)	📦 (pcs.)
503760^	KO14118A2426	3/4x13/16	1/2"	30	17.5	13	57	185	10

**14201M**

Wheel Nut Sockets Set Extra Thin-walled



3 Piece Set  
CARDBOARD BOX:W125xH95xT34mm

⚖ = 690g

Item Code	Part No.	Sockets
503770	KO14201M	14145PM.110 Impact Wheel Nut Sockets 17, 19, 21mm

**14124/3** Lock Nut Busters (Double Ended) in set



3 Piece Set  
CARDBOARD BOX:W125xH91xT43mm

⚖ = 580g

Item Code	Part No.	Sockets	Accessories
503764	KO14124/3	14124: Lock Nut Buster 21x24.5 26x27.5	14760-75B

**14145PM-110**

Wheel Nut Sockets, Extra Thin-walled

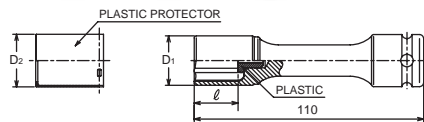

A detachable plastic protector is fitted to the socket to prevent damage to the wheel when working in tight areas. The socket size and Ko-ken mark printed on the shaft makes it easier to see if the socket is still rotating or stopped.

**Impact Wheel Nut Sockets-Extra Thin wall**  
Special design for wheel nut work.  
-110mm length gives socket extra reach for nuts recessed deep inside the wheel and ideal for Aluminum wheel nuts where access to nut is very tight.  
-Blue (17mm), Red (19mm), Yellow (21mm) and White (22mm), colour coded shafts make size identification easy.  
-Plastic insert helps prevent damaged to wheel nut.

⚠ Please note that thin walled design is only for wheel nut work and Torque rating is limited.

Item Code	Part No.	14145PM.110 (mm)	□	D1 (mm)	D2 (mm)	l (mm)	Shaft Color	⚖ (g)	📦 (pcs.)	⚙
503765	KO14145PM17	17		23.7	25.2	21	Blue	223	5	*1
503766	KO14145PM19	19	1/2"	25.7	27.2	23	Red	231	5	*1
503767	KO14145PM21	21		27.5	29.5	25	Yellow	236	5	*1

\*1 C-Ring=1401C, Pin/O-Ring=1401A/B

**KP14101** Torsion Bars (for tightening only)



Item Code	Part No.	KP14101 (mmxNm)	□	D (mm)	l (mm)	L (mm)	Shaft Color	⚖ (g)	📦 (pcs.)	⚙
503752^	KO14101MP1775	17x 75Nm		22	11	208	Green	230	1	*1
503753^	KO14101MP1795	17x 95Nm		25.7	12	214	Light Green	256	1	*1
503751^	KO14101MP17110	17x110Nm		24	21	204	Orange	230	10	*1
503755^	KO14101MP1960	19x 60Nm		28.2	13	219	Dark Blue	237	1	*1
503756^	KO14101MP1990	19x 90Nm	1/2"	26	24	259	Yellow	250	10	*1
503754^	KO14101MP19120	19x120Nm		28.2	13	203	Light Blue	297	1	*1
503757^	KO14101MP21100	21x100Nm		30.7	14	214	Black	288	1	*1
503758^	KO14101MP21120	21x120Nm		30.7	14	203	Brown	288	1	*1

\*1 C-Ring=1401C, Pin/O-Ring=1401A/B

**How to use Torsion Bar:**

1. Use with a 1/2" Sq. Dr. Pneumatic impact wrench.
2. Set air pressure 0.6MPa, and set impact wrench dial Medium range.
3. Choose a suitable Torsion bar according to wheel nut size and indicated tightening torque.
4. Attach the torsion bar to impact wrench and apply load.
5. Check the actual tightening torque value with torque wrench.
6. Adjust air pressure or torque value according to the results of check 5.
7. Tighten other wheel nut in diagonal order.

**Torsion Bars**

- Designed for tightening wheel nuts with an impact wrench.
- Prevent the excessive torque load.
- Color coded shafts make size identification easy.

# 1/2" Impact Sockets & Accessories



**KP14101/6H**  Metal-Wall-Hanger for Workshops

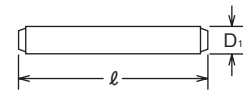
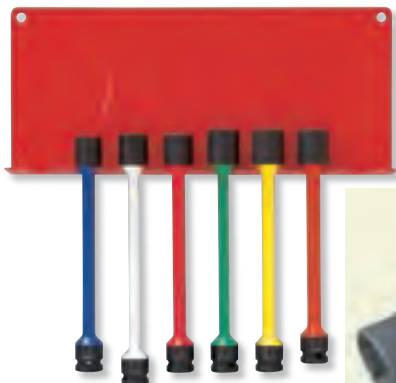

**1401A** Spare Pin

**1402A**





Item Code	Part No.		Opening (mm)	D <sub>1</sub> (mm)	l (mm)	 (pcs.)
503743	KO1401A	1/2"	≤ 14	3.5	20	100
503746	KO1402A	1/2"	> 14	3.5	25	100



**1401B** Spare Ring

**1402B**



Item Code	Part No.		Opening (mm)	D <sub>2</sub> (mm)	D <sub>3</sub> (mm)	 (pcs.)
503744	KO1401B	1/2"	≤ 14	4	19	100
503747	KO1402B	1/2"	> 14	4	24	100

HANGER

Item Code	Part No.		Torsion Bar Set	 (g)
505528 <sup>^</sup>	KOKP14101/6H		<b>KP14101: 6 Piece Set</b> Impact Torsion Bars (Thin walled) 17×110Nm, 19×90Nm, 19×110Nm, 21×100Nm, 21×110Nm, 21×130Nm	2,230

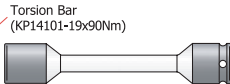
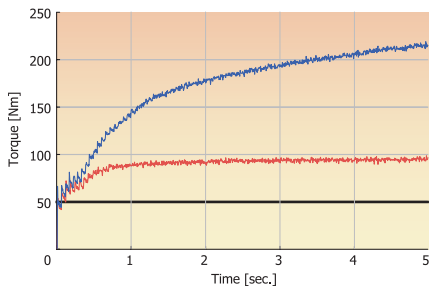

Wrench : IR231  
Air pressure : 0,6MPa

**1401C-10** C-Ring 10 Clips + Puller

**1402C-10**

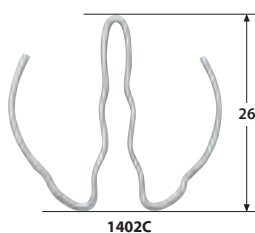
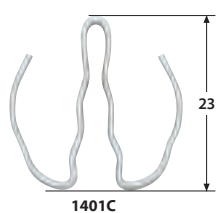

Item Code	Part No.		Opening (mm)	C-Ring 10pcs.	Puller 1pce.
503745 <sup>^</sup>	KOPK1401C-10	1/2"	≤ 14	1401C + 149	
503748 <sup>^</sup>	KOPK1402C-10	1/2"	> 14	1402C + 149	



One Piece solid springs steel ring. Simply set by finger pushing and easily removed by puller. Much more convenient and safer than combination of pin and o-ring.

# 1/2" Impact Sockets & Accessories

**14241M**
 Impact Socket Set

**14241A**

 13 Piece Set  
 METAL CASE:W196xH100xT45mm ⚖️ = 2,000g

Item Code	Part No.		Sockets
503776	KO14241M		<b>14400M</b> 6-pt. Sockets 10, 11, 12, 13, 14, 15, 16, 17, 19, 21, 22, 24, 27mm

 12 Piece Set  
 METAL CASE:W196xH100xT45mm ⚖️ = 1,970g

Item Code	Part No.		Sockets
503775	KO14241A		<b>14400A</b> 6-pt. Sockets 3/8, 7/16, 1/2, 9/16, 5/8, 11/16, 3/4, 13/16, 7/8, 15/16, 1, 1.1/8"

**14200M11**
 Impact Socket Set

**14200A10**

 11 Piece Set  
 METAL CASE:W198xH103xT47mm ⚖️ = 1,865g

Item Code	Part No.		Sockets
503769	KO14200M11		<b>14400M</b> 6-pt. Sockets 10, 12, 13, 14, 15, 16, 17, 18, 19, 21, 24mm

 10 Piece Set  
 METAL CASE:W198xH103xT47mm ⚖️ = 1,750g

Item Code	Part No.		Sockets
503768 <sup>^</sup>	KO14200A10		<b>14400A</b> 6-pt. Sockets 1/2, 9/16, 5/8, 11/16, 3/4, 13/16, 7/8, 15/16, 1, 1.1/16"



# 3/4" Impact Sockets & Accessories

## 16400M · 16400A

6-point Sockets

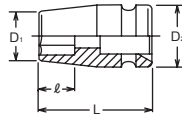

Item Code	Part No.	16400M (mm)	D <sub>1</sub> (mm)	D <sub>2</sub> (mm)	ℓ (mm)	L (mm)	(g)	(pcs.)	⚡
504004	KO16400M17	17	30	44	12	50	355	5	*1
504005	KO16400M18	18	31.3	44	13	50	372	5	*1
504006	KO16400M19	19	32.5	44	13	50	360	5	*1
504007	KO16400M20	20	33.8	44	14	50	375	5	*1
504008	KO16400M21	21	35	44	15	50	374	5	*1
504009	KO16400M22	22	36.3	44	15	50	373	5	*1
504010	KO16400M23	23	37.5	44	16	50	373	5	*1
504011	KO16400M24	24	38.8	44	16	50	370	5	*1
504012	KO16400M25	25	40	44	16	50	374	5	*1
504013	KO16400M26	26	41.3	44	16	50	378	5	*1
504014	KO16400M27	27	42.5	44	16	50	375	5	*1
504015	KO16400M28	28	43.8	44	16	50	383	5	*1
504016	KO16400M29	29	45	44	18	53	412	5	*1
504017	KO16400M30	30	46.3	44	18	53	410	5	*1
504018	KO16400M31	31	47.5	44	18	53	426	5	*1
504019	KO16400M32	32	48.8	44	19	53	428	5	*1
504020	KO16400M33	33	50	44	20	55	470	5	*1
504021	KO16400M34	34	51.3	44	20	55	490	5	*1
504022	KO16400M35	35	52.5	44	20	55	494	5	*1
504023	KO16400M36	36	53.8	44	20	55	498	5	*1
504024	KO16400M38	38	56.3	44	20	57	558	2	*1
504025	KO16400M41	41	60	44	22	57	572	2	*1
504026	KO16400M42	42	61.3	44	22	57	617	2	*1
504027	KO16400M46	46	66.3	44	23	62	755	2	*1
504028	KO16400M50	50	71.3	54	30	62	930	2	*2
504029	KO16400M54	54	76.3	54	29	62	1035	2	*2
504030	KO16400M55	55	77.5	54	29	62	1056	2	*2
504031	KO16400M56	56	78.8	54	29	62	1091	2	*2
504032	KO16400M58	58	81.3	54	31	65	1163	2	*2
504033	KO16400M60	60	83.8	54	31	65	1215	2	*2

\*1 C-Ring=1600C, Pin/O-Ring=1601A/B  
\*2 C-Ring=1801C, Pin/O-Ring=1602A/B

Item Code	Part No.	16400A (inch)	D <sub>1</sub> (mm)	D <sub>2</sub> (mm)	ℓ (mm)	L (mm)	(g)	(pcs.)	⚡
503976	KO16400A22	11/16	30	44	12	50	355	5	*1
503977	KO16400A24	3/4	32.5	44	13	50	360	5	*1
503978	KO16400A26	13/16	35	44	15	50	374	5	*1
503979	KO16400A28	7/8	36.3	44	15	50	373	5	*1
503980	KO16400A30	15/16	38.8	44	16	50	370	5	*1
503981	KO16400A32	1	40	44	16	50	374	5	*1
503982	KO16400A34	1. 1/16	42.5	44	16	50	375	5	*1
503983	KO16400A36	1. 1/8	45	44	18	53	412	5	*1
503984	KO16400A38	1. 3/16	46.3	44	18	53	410	5	*1
503985	KO16400A40	1. 1/4	48.8	44	19	53	428	5	*1
503986	KO16400A42	1. 5/16	51.3	44	20	55	490	5	*1
503987	KO16400A44	1. 3/8	52.5	44	20	55	494	5	*1
503988	KO16400A46	1. 7/16	55	44	20	55	526	2	*1
503989	KO16400A48	1. 1/2	56.3	44	20	57	558	2	*1
503990	KO16400A50	1. 9/16	58.8	44	20	57	598	2	*1
503991	KO16400A52	1. 5/8	60	44	22	57	572	2	*1
503992	KO16400A54	1.11/16	62.5	44	23	62	720	2	*1
503993	KO16400A56	1. 3/4	65	44	23	62	757	2	*1
503994	KO16400A58	1.13/16	66.3	44	23	62	755	2	*1
503995	KO16400A60	1. 7/8	68.8	54	23	62	940	2	*2
503996	KO16400A62	1.15/16	70	54	23	62	912	2	*2
503997	KO16400A64	2	72.5	54	30	62	969	2	*2
503998	KO16400A66	2. 1/16	73.8	54	29	62	1011	2	*2
503999	KO16400A68	2. 1/8	76.3	54	29	62	1035	2	*2
504000	KO16400A70	2. 3/16	77.5	54	29	62	1056	2	*2
504001	KO16400A72	2. 1/4	80	54	32	65	1126	2	*2
504002	KO16400A74	2. 5/16	81.3	54	31	65	1163	2	*2
504003	KO16400A76	2. 3/8	83.8	54	31	65	1215	2	*2

## 16300M · 16300A

6-point Sockets, deep

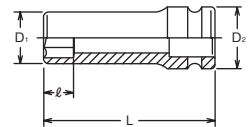

Item Code	Part No.	16300M (mm)	D <sub>1</sub> (mm)	D <sub>2</sub> (mm)	ℓ (mm)	L (mm)	(g)	(pcs.)	⚡
503936	KO16300M19	19	32.5	44	19	100	655	2	*1
503937	KO16300M20	20	33.8	44	20	100	680	2	*1
503938	KO16300M21	21	35	44	21	100	700	2	*1
503939	KO16300M22	22	36.3	44	22	100	700	2	*1
503940	KO16300M23	23	37.5	44	23	100	720	2	*1
503941	KO16300M24	24	38.8	44	24	100	705	2	*1
503942	KO16300M25	25	40	44	25	100	715	2	*1
503943	KO16300M26	26	41.3	44	26	100	760	2	*1
503944	KO16300M27	27	42.5	44	27	100	765	2	*1
503945	KO16300M28	28	43.8	44	28	100	800	2	*1
503946	KO16300M29	29	45	44	29	100	835	2	*1
503947	KO16300M30	30	46.3	44	30	100	840	2	*1
503948	KO16300M31	31	47.5	44	31	100	815	2	*1
503949	KO16300M32	32	48.8	44	32	100	875	2	*1
503950	KO16300M33	33	50	44	33	100	920	2	*1
503951	KO16300M34	34	51.3	44	34	100	950	2	*1
503952	KO16300M35	35	52.5	44	35	100	980	2	*1
503953	KO16300M36	36	53.8	44	36	100	960	2	*1
503954	KO16300M37	37	55	44	37	100	970	2	*1
503955	KO16300M38	38	56.3	44	38	100	990	2	*1
503956	KO16300M41	41	60	44	38	100	1120	2	*1
503957	KO16300M42	42	61.3	44	38	100	1153	2	*1
503958	KO16300M46	46	66.3	44	38	100	1305	2	*1
503959	KO16300M50	50	71.3	54	61	100	1469	2	*2

\*1 C-Ring=1600C, Pin/O-Ring=1601A/B  
\*2 C-Ring=1801C, Pin/O-Ring=1602A/B

Item Code	Part No.	16300A (inch)	D <sub>1</sub> (mm)	D <sub>2</sub> (mm)	ℓ (mm)	L (mm)	(g)	(pcs.)	⚡
503916	KO16300A24	3/4	32.5	44	19	100	655	2	*1
503917	KO16300A26	13/16	35	44	21	100	700	2	*1
503918	KO16300A28	7/8	36.3	44	22	100	700	2	*1
503919	KO16300A30	15/16	38.8	44	24	100	705	2	*1
503920	KO16300A32	1	40	44	25	100	715	2	*1
503921	KO16300A34	1. 1/16	42.5	44	27	100	765	2	*1
503922	KO16300A36	1. 1/8	45	44	29	100	835	2	*1
503923	KO16300A38	1. 3/16	46.3	44	30	100	840	2	*1
503924	KO16300A40	1. 1/4	48.8	44	32	100	875	2	*1
503925	KO16300A42	1. 5/16	51.3	44	34	100	950	2	*1
503926	KO16300A44	1. 3/8	52.5	44	35	100	980	2	*1
503927	KO16300A46	1. 7/16	55	44	37	100	970	2	*1
503928	KO16300A48	1. 1/2	56.3	44	38	100	990	2	*1
503929	KO16300A50	1. 9/16	58.8	44	38	100	1060	2	*1
503930	KO16300A52	1. 5/8	60	44	38	100	1120	2	*1
503931	KO16300A54	1.11/16	62.5	44	38	100	1200	2	*1
503932	KO16300A56	1. 3/4	65	44	38	100	1284	2	*1
503933	KO16300A58	1.13/16	66.3	44	38	100	1305	2	*1
503934	KO16300A60	1. 7/8	68.8	54	38	100	1561	2	*2
503935	KO16300A64	2	72.5	54	60	100	1516	2	*2

\*1 C-Ring=1600C, Pin/O-Ring=1601A/B  
\*2 C-Ring=1801C, Pin/O-Ring=1602A/B

**Korfen**

# 3/4" Impact Sockets & Accessories

## 16301M 6-point Deep Sockets, Thin Walled

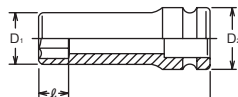
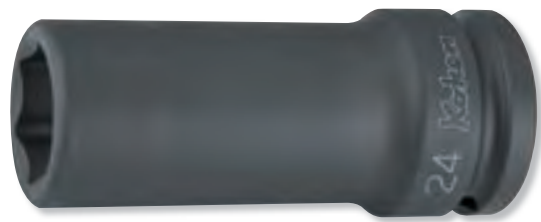

Item Code	Part No.	16301M (mm)	D <sub>1</sub> (mm)	D <sub>2</sub> (mm)	ℓ (mm)	L (mm)	(g)	(pcs.)	
503961	KO16301M17	17	28	43	17	100	470	2	*1
503962	KO16301M24	24	36.8	43	24	100	560	2	*1
503963	KO16301M27	27	40.5	43	27	100	610	2	*1
503964	KO16301M30	30	44.3	43	30	100	670	2	*1
503965	KO16301M32	32	46.8	43	32	100	715	2	*1
503966 <sup>^</sup>	KO16301M33	33	48	43	33	100	730	2	*1

\*1 C-Ring=1600C, Pin/O-Ring=1601A/B

## 16106-16 Hex bit sockets

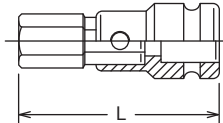

Item Code	Part No.	16106-16 (mm)	L (mm)	(g)	(pce.)	
503904	KO16106-16M10	10	76	416	1	*1
503905	KO16106-16M14	14	76	430	1	*1
503906	KO16106-16M17	17	76	443	1	*1
503907	KO16106-16M19	19	76	450	1	*1
503908	KO16106-16M22	22	76	473	1	*1

\*1 C-Ring=1600C, Pin/O-Ring=1601A/B

## 16106 Bit Holder, For 107-16

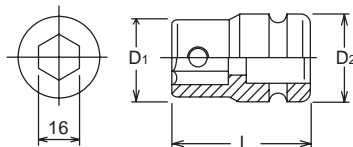

Item Code	Part No.	D <sub>1</sub> (mm)	D <sub>2</sub> (mm)	L (mm)	(g)	(pcs.)	
503903	KO16106	32	44	52	370	2	*1

\*1 C-Ring=1600C, Pin/O-Ring=1601A/B

Replacement Screw : M6x10, 3mm

## 107-16 Bits for Inhex screws

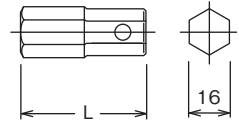

Item Code	Part No.	107.16 (mm)	L (mm)	(g)	(pcs.)
503631	KO10716M10	10	40	46	10
503632	KO10716M12	12	40	52	10
503633	KO10716M14	14	40	60	10
503634	KO10716M17	17	40	73	10
503635	KO10716M19	19	40	80	10
503636	KO10716M22	22	40	97	10

## 16204AM Hex Bit Set



9 Piece Set  
METAL CASE: W215xH80xT47mm = 1,200g

Item Code	Part No.	Bit Holder	Hex Bit - 16H Shank
503914	KO16204AM	16106	107-16: 12, 14, 17, 19mm 107-16: 1/2, 9/16, 5/8"

## 107-16 (T) TORX® Bits

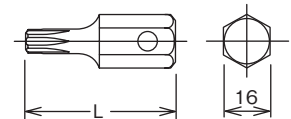

Item Code	Part No.	107.16 (T)	L (mm)	(g)	(pcs.)
503637	KO10716T55	T55	50	57	10
503638	KO10716T60	T60	50	64	10
503639	KO10716T70	T70	50	73	10

## 16107-22 Hex bit sockets

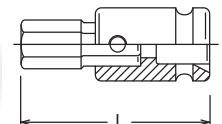

Item Code	Part No.	16107.22 (mm)	L (mm)	(g)	(pce.)	
503910 <sup>^</sup>	KO16107-22M24	24	88	706	1	*1
503911 <sup>^</sup>	KO16107-22M27	27	88	730	1	*1

\*1 C-Ring=1600C, Pin/O-Ring=1601A/B

# 3/4" Impact Sockets & Accessories

## 16107 Bit Holder

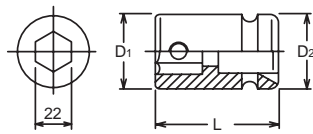

Item Code	Part No.	D <sub>1</sub> (mm)	D <sub>2</sub> (mm)	L (mm)	(g)	(pcs.)	
503909	KO16107	44	44	60	530	2	*1

\*1 C-Ring=1600C, Pin/O-Ring=1601A/B

Replacement Screw : M8x14, 4mm

## 16760 Extension Bars

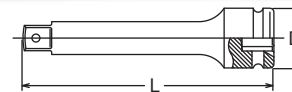

Item Code	Part No.	D (mm)	L (mm)	(g)	(pce.)	
504043	KO16760175	44	175	870	1	*1
504044	KO16760250	44	250	1150	1	*1
504045	KO16760330	44	330	1460	1	*1

\*1 C-Ring=1600C, Pin/O-Ring=1601A/B

## 107-22 Bits for Inhex Screws

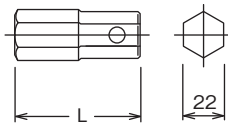

Item Code	Part No.	107.22 (mm)	L (mm)	(g)	(pcs.)
503640 <sup>^</sup>	KO10722M19	19	50	140	10
503641 <sup>^</sup>	KO10722M22	22	50	162	10
503642 <sup>^</sup>	KO10722M24	24	50	176	10
503643 <sup>^</sup>	KO10722M27	27	50	200	10

## 16770 Universal Joint

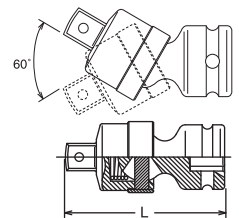

Item Code	Part No.	L (mm)	(g)	(pce.)	
504046	KO16770	106	790	1	*1

\*1 C-Ring=1600C, Pin/O-Ring=1601A/B

## 16205M Hex Bit Set



6 Piece Set  
METAL CASE: W215xH80xT47mm

= 1,650g

Item Code	Part No.	Bit Holder	Hex Bit - 22H Shank
503915	KO16205M	16107	107-22: 17, 19, 22, 24, 27mm

## 16771 Universal Joint

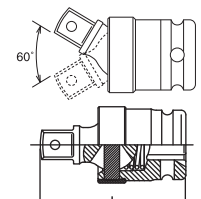

Item Code	Part No.	L (mm)	(g)	(pce.)	
504048 <sup>^</sup>	KO16771	95	720	1	*1

\*1 C-Ring=1600C, Pin/O-Ring=1601A/B

## 107-22 (T) TORX® Bits

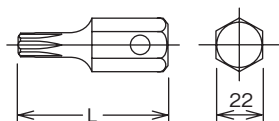

Item Code	Part No.	107.22 (T)	L (mm)	(g)	(pcs.)
503645	KO10722T80	T 80	60	141	10
503646	KO10722T90	T 90	60	155	10
503644	KO10722T100	T100	60	170	10

## 16644A Reducer

No Warranty

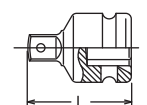

Item Code	Part No.	(sq.)	(sq.)	L (mm)	(g)	(pce.)	
504034	KO16644A	3/4"	1/2"	52	310	1	*1

**Korpen**

# 3/4" Impact Sockets & Accessories

## 16688A Adaptor



Item Code	Part No.	□ (sq.)	□ (sq.)	L (mm)	⚖ (g)	📦 (pce.)	⚙
504035	KO16688A	3/4"	1"	62	435	1	*1

\*1 C-Ring=1600C, Pin/O-Ring=1601A/B

## 1600C-10 C-Ring 10 Clips + Puller

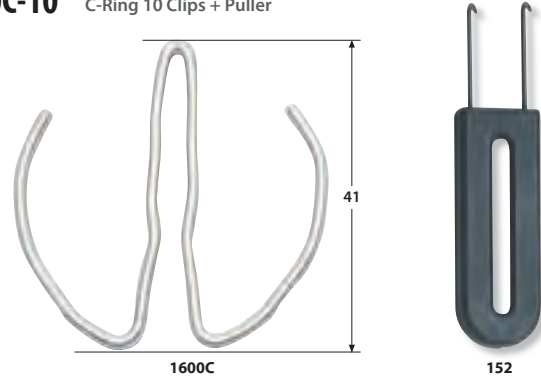

Item Code	Part No.	□	Opening (mm)	C-Ring 10pcs.	Puller 1pce.
503900^	KO1600C-10	3/4"	≤ 46	1600C + 152	

## 16316M Rear Wheel Nut Sockets

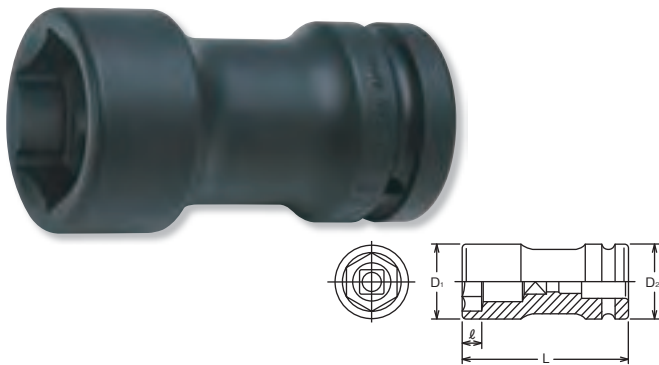

Item Code	Part No.	16316M (mm×mm)	□	D <sub>1</sub> (mm)	D <sub>2</sub> (mm)	l (mm)	L (mm)	⚖ (g)	📦 (pce.)	⚙
503967	KO16316M3517	35×17	3/4"	52	44	10	90	865	1	*1
503968	KO16316M3820	38×20		56	44	13	100	952	1	*1
503969	KO16316M4119	41×19		59	44	12	100	1037	1	*1
503970	KO16316M4121	41×21		59	44	15	100	963	1	*1

\*1 C-Ring=1600C, Pin/O-Ring=1601A/B



## 16317M Rear Wheel Nut Sockets



Item Code	Part No.	16317M (mm)	□	D <sub>1</sub> (mm)	D <sub>2</sub> (mm)	l (mm)	L (mm)	⚖ (g)	📦 (pce.)	⚙
503971	KO16317M17	17	3/4"	40	44	22.5	67	485	1	*1
503972	KO16317M19	19		40	44	22.5	67	462	1	*1
503973	KO16317M20	20		44	44	22.5	67	517	1	*1
503974	KO16317M21	21		44	44	22.5	67	489	1	*1
503975	KO16317M22	22		44	44	22.5	67	482	1	*1

\*1 C-Ring=1600C, Pin/O-Ring=1601A/B

## 1601A Spare Pin



Item Code	Part No.	□	Opening (mm)	D <sub>1</sub> (mm)	l (mm)	📦 (pcs.)
503901	KO1601A	3/4"	≤ 46	5.5	35	100

## 1601B Spare Ring



Item Code	Part No.	□	Opening (mm)	D <sub>2</sub> (mm)	D <sub>3</sub> (mm)	📦 (pcs.)
503902	KO1601B	3/4"	≤ 46	5	36	100

**Kokem**

# 3/4" Impact Sockets & Accessories

## 16200M6 Impact Socket Set



6 Piece Set  
METAL CASE: W290xH124xT69mm  $\Delta = 3,700g$

Item Code	Part No.	Sockets
503913	KO16200M6	16200M 6-pt. Sockets 22, 24, 27, 30, 32, 36mm

## 16200A8 Impact Socket Set



8 Piece Set  
METAL CASE: W290xH124xT69mm  $\Delta = 4,700g$

Item Code	Part No.	Sockets
503912 <sup>^</sup>	KO16200A8	16200A 6-pt. Sockets 15/16, 1, 1.1/16, 1.1/8, 1.3/16, 1.1/4, 1.5/16, 1.1/2"

# 1" Impact Sockets & Accessories

## 18400M · 18400A 6-point Sockets

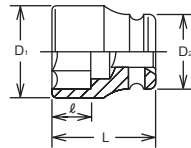

Item Code	Part No.	18400M (mm)	D <sub>1</sub> (mm)	D <sub>2</sub> (mm)	ℓ (mm)	L (mm)	$\Delta$ (g)		
504192	KO18400M21	21	37.8	54	15	57	605	2	*1
504193	KO18400M22	22	39	54	15	57	620	2	*1
504194	KO18400M23	23	40.3	54	16	57	615	2	*1
504195	KO18400M24	24	41.5	54	16	57	627	2	*1
504196	KO18400M25	25	42.8	54	16	57	620	2	*1
504197	KO18400M26	26	44	54	16	57	640	2	*1
504198	KO18400M27	27	45.3	54	16	57	627	2	*1
504199	KO18400M28	28	46.5	54	16	57	640	2	*1
504200	KO18400M29	29	47.8	54	18	57	657	2	*1
504201	KO18400M30	30	49	54	21	62	657	2	*1
504202	KO18400M31	31	50.3	54	21	62	687	2	*1
504203	KO18400M32	32	51.5	54	21	62	685	2	*1
504204	KO18400M33	33	52.8	54	21	62	685	2	*1
504205	KO18400M34	34	54	54	21	62	690	2	*1
504206	KO18400M35	35	55.3	54	21	62	710	2	*1
504207	KO18400M36	36	56.5	54	21	62	712	2	*1
504208	KO18400M38	38	59	54	25	66	720	2	*1
504209	KO18400M40	40	61.5	54	25	66	850	2	*1
504210	KO18400M41	41	62.8	54	25	66	850	2	*1
504211	KO18400M42	42	64	54	25	66	905	2	*1
504212	KO18400M45	45	67.8	54	27	68	963	2	*1
504213	KO18400M46	46	69	54	29	70	1010	2	*1
504214	KO18400M50	50	74	54	35	70	1065	2	*1
504215	KO18400M52	52	76.5	54	40	75	1185	2	*1
504216	KO18400M55	55	80.3	54	39	75	1260	2	*1
504217	KO18400M60	60	86.5	54	39	75	1400	2	*1
504218	KO18400M63	63	90.3	54	38	75	1383	2	*1
504219	KO18400M65	65	92.8	54	38	75	1630	2	*1
504220	KO18400M70	70	99	54	37	75	1625	1	*1
504221	KO18400M75	75	105.3	86	37	80	2675	1	*2
504222	KO18400M80	80	111.5	86	41	85	2996	1	*2
504223	KO18400M85	85	117.8	86	37	90	3378	1	*2
504224	KO18400M90	90	124	86	40	95	3871	1	*2

Item Code	Part No.	18400A (inch)	D <sub>1</sub> (mm)	D <sub>2</sub> (mm)	ℓ (mm)	L (mm)	$\Delta$ (g)		
504151	KO18400A026	13/16	37.8	54	15	57	605	2	*1
504152	KO18400A028	7/8	39	54	15	57	620	2	*1
504153	KO18400A030	15/16	41.5	54	16	57	627	2	*1
504154	KO18400A032	1	42.8	54	16	57	620	2	*1
504155	KO18400A034	1. 1/16	45.3	54	16	57	627	2	*1
504156	KO18400A036	1. 1/8	47.8	54	18	57	657	2	*1
504157	KO18400A038	1. 3/16	49	54	21	62	657	2	*1
504158	KO18400A040	1. 1/4	51.5	54	21	62	685	2	*1
504159	KO18400A042	1. 5/16	54	54	21	62	690	2	*1
504160	KO18400A044	1. 3/8	55.3	54	21	62	710	2	*1
504161	KO18400A046	1. 7/16	57.8	54	21	62	735	2	*1
504162	KO18400A048	1. 1/2	59	54	25	66	720	2	*1
504163	KO18400A050	1. 9/16	61.5	54	25	66	850	2	*1
504164	KO18400A052	1. 5/8	62.8	54	25	66	850	2	*1
504165	KO18400A054	1.11/16	65.3	54	27	68	977	2	*1
504166	KO18400A056	1. 3/4	67.8	54	27	68	963	2	*1
504167	KO18400A058	1.13/16	69	54	29	70	1010	2	*1
504168	KO18400A060	1. 7/8	71.5	54	35	70	990	2	*1
504169	KO18400A062	1.15/16	72.8	54	35	70	1000	2	*1
504170	KO18400A064	2	75.3	54	35	70	1060	2	*1
504171	KO18400A066	2. 1/16	76.5	54	40	75	1185	2	*1
504172	KO18400A068	2. 1/8	79	54	40	75	1252	2	*1
504173	KO18400A070	2. 3/16	80.3	54	39	75	1260	2	*1
504174	KO18400A072	2. 1/4	82.8	54	39	75	1337	2	*1
504175	KO18400A074	2. 5/16	84	54	39	75	1340	2	*1
504176	KO18400A076	2. 3/8	86.5	54	39	75	1400	2	*1
504177	KO18400A078	2. 7/16	89	54	38	75	1410	2	*1
504178	KO18400A080	2. 1/2	91.5	54	38	75	1498	2	*1
504179	KO18400A082	2. 9/16	92.8	54	38	75	1630	2	*1
504180	KO18400A084	2. 5/8	95.3	54	38	75	1580	2	*1
504181	KO18400A086	2.11/16	96.5	54	37	75	1583	1	*1
504182	KO18400A088	2. 3/4	99	54	37	75	1625	1	*1
504183	KO18400A090	2.13/16	101.5	86	37	80	2705	1	*2
504184	KO18400A092	2. 7/8	102.8	86	38	80	2629	1	*2
504185	KO18400A094	2.15/16	105.3	86	37	80	2675	1	*2
504186	KO18400A096	3	106.5	86	37	80	2705	1	*2
504187	KO18400A098	3. 1/16	109	86	42	85	2967	1	*2
504188	KO18400A100	3. 1/8	111.5	86	41	85	2996	1	*2
504189	KO18400A104	3. 1/4	115.3	86	44	90	3328	1	*2
504190	KO18400A108	3. 3/8	119	86	36	90	3389	1	*2
504191	KO18400A112	3. 1/2	124	86	40	95	3871	1	*2

\*1 C-Ring=1801C, Pin/O-Ring=1801A/B  
\*2 C-Ring=1802C, Pin/O-Ring=1802A/B

\*1 C-Ring=1801C, Pin/O-Ring=1801A/B  
\*2 C-Ring=1802C, Pin/O-Ring=1802A/B

# 1" Impact Sockets & Accessories

## 18300M · 18300A

6-point Sockets, deep

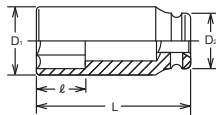

Item Code	Part No.	18300M (mm)	D <sub>1</sub> (mm)	D <sub>2</sub> (mm)	ℓ (mm)	L (mm)	(g)	(pcs.)	⚡
504125	KO18300M22	22	39	54	22	108	1010	2	*1
504126	KO18300M23	23	40.3	54	26	108	1063	2	*1
504127	KO18300M24	24	41.5	54	24	108	1060	2	*1
504128	KO18300M25	25	42.8	54	25	108	1085	2	*1
504129	KO18300M26	26	44	54	26	108	1133	2	*1
504130	KO18300M27	27	45.3	54	27	108	1125	2	*1
504131	KO18300M28	28	46.5	54	28	108	1140	2	*1
504132	KO18300M29	29	47.8	54	29	108	1120	2	*1
504133	KO18300M30	30	49	54	30	108	1179	2	*1
504134	KO18300M31	31	50.3	54	31	108	1125	2	*1
504135	KO18300M32	32	51.5	54	32	108	1200	2	*1
504136	KO18300M33	33	52.8	54	33	108	1200	2	*1
504137	KO18300M34	34	54	54	34	108	1280	2	*1
504138	KO18300M35	35	55.3	54	35	108	1300	2	*1
504139	KO18300M36	36	56.5	54	36	108	1280	2	*1
504140	KO18300M38	38	59	54	38	108	1423	2	*1
504141	KO18300M41	41	62.8	54	38	108	1450	2	*1
504142	KO18300M42	42	64	54	38	108	1550	2	*1
504143	KO18300M46	46	69	54	38	108	1680	2	*1
504144	KO18300M48	48	71.5	54	67	108	1500	2	*1
504145	KO18300M50	50	74	54	66	108	1650	2	*1
504146	KO18300M52	52	76.5	54	65	108	1770	2	*1
504147	KO18300M55	55	80.3	54	63	108	1855	2	*1
504148	KO18300M60	60	86.5	54	60	108	2047	2	*1
504149	KO18300M65	65	92.8	54	58	108	2310	2	*1
504150	KO18300M70	70	99	54	55	108	2440	1	*1

\*1 C-Ring=1801C, Pin/O-Ring=1801A/B  
\*2 C-Ring=1802C, Pin/O-Ring=1802A/B

Item Code	Part No.	18300A (inch)	D <sub>1</sub> (mm)	D <sub>2</sub> (mm)	ℓ (mm)	L (mm)	(g)	(pcs.)	⚡
504098	KO18300A28	7/8	39	54	22	108	1010	2	*1
504099	KO18300A30	15/16	41.5	54	24	108	1060	2	*1
504100	KO18300A32	1	42.8	54	25	108	1085	2	*1
504101	KO18300A34	1. 1/16	45.3	54	27	108	1125	2	*1
504102	KO18300A36	1. 1/8	47.8	54	29	108	1120	2	*1
504103	KO18300A38	1. 3/16	49	54	30	108	1179	2	*1
504104	KO18300A40	1. 1/4	51.5	54	32	108	1200	2	*1
504105	KO18300A42	1. 5/16	54	54	34	108	1280	2	*1
504106	KO18300A44	1. 3/8	55.3	54	35	108	1300	2	*1
504107	KO18300A46	1. 7/16	57.8	54	37	108	1320	2	*1
504108	KO18300A48	1. 1/2	59	54	38	108	1423	2	*1
504109	KO18300A50	1. 9/16	61.5	54	38	108	1415	2	*1
504110	KO18300A52	1. 5/8	62.8	54	38	108	1450	2	*1
504111	KO18300A54	1.11/16	65.3	54	38	108	1577	2	*1
504112	KO18300A56	1. 3/4	67.8	54	38	108	1660	2	*1
504113	KO18300A58	1.13/16	69	54	38	108	1680	2	*1
504114	KO18300A60	1. 7/8	71.5	54	67	108	1500	2	*1
504115	KO18300A62	1.15/16	72.8	54	67	108	1570	2	*1
504116	KO18300A64	2	75.3	54	66	108	1605	2	*1
504117	KO18300A66	2. 1/16	76.5	54	65	108	1770	2	*1
504118	KO18300A68	2. 1/8	79	54	64	108	1812	2	*1
504119	KO18300A70	2. 3/16	80.3	54	63	108	1855	2	*1
504120	KO18300A72	2. 1/4	82.8	54	62	108	1916	2	*1
504121	KO18300A74	2. 5/16	84	54	61	108	1987	2	*1
504122	KO18300A76	2. 3/8	86.5	54	60	108	2047	2	*1
504123	KO18300A78	2. 7/16	89	54	59	108	2041	2	*1
504124	KO18300A80	2. 1/2	91.5	54	58	108	2250	2	*1

\*1 C-Ring=1801C, Pin/O-Ring=1801A/B  
\*2 C-Ring=1802C, Pin/O-Ring=1802A/B

## 18760

Extension Bars

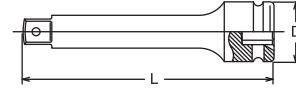

Item Code	Part No.	D (mm)	L (mm)	(g)	(pce.)	⚡
504225	KO18760175	54	175	1400	1	*1
504226	KO18760200	54	200	1580	1	*1
504227	KO18760250	54	250	1885	1	*1
504228	KO18760330	54	330	2380	1	*1

\*1 C-Ring=1801C, Pin/O-Ring=1801A/B

## 18770

Universal Joint



Item Code	Part No.	L (mm)	(g)	(pce.)	⚡
504229	KO18770	127	1210	1	*1

\*1 C-Ring=1801C, Pin/O-Ring=1801A/B

## 18866A

Reducer No Warranty



Item Code	Part No.	(sq.)	(sq.)	L (mm)	(g)	(pce.)	⚡
504231	KO18866A	1"	3/4"	65	580	1	*1

\*1 C-Ring=1801C, Pin/O-Ring=1801A/B

Adapting down from bigger square drive to smaller square drive may lead to excessive torque load and possibly cause breakage. Always stay within safe torque of the smaller square drive.

**Kokoro**

# 1" Impact Sockets & Accessories

## 18877A Adaptor

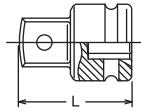

Item Code	Part No.	□ (sq.)	□ (sq.)	L (mm)	⚖ (g)	📦 (pce.)	⚡
504232 <sup>^</sup>	KO18877A	1"	1.1/2"	80	935	1	*1

\*1 C-Ring=1801C, Pin/O-Ring=1801A/B

## 1801A Spare Pin

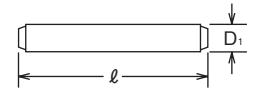

Item Code	Part No.	□	Opening (mm)	D <sub>1</sub> (mm)	l (mm)	📦 (pcs.)
504089 <sup>^</sup>	KO1801A	1"	≤ 70	6	45	100

## 1801B Spare Ring



Item Code	Part No.	□	Opening (mm)	D <sub>2</sub> (mm)	D <sub>3</sub> (mm)	📦 (pcs.)
504090 <sup>^</sup>	KO1801B	1"	≤ 70	7	45	100

## 1801C-10 C-Ring 10 Clips + Puller

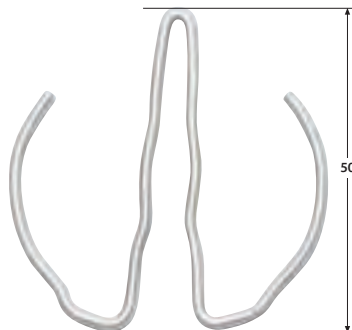

1801C



152

Item Code	Part No.	□	Opening (mm)	C-Ring 10pcs.	Puller 1pce.
504091	KO1801C-10	1"	≤ 70	1801C + 152	

One Piece solid springs steel ring. Simply set by finger pushing and easily removed by puller. Much more convenient and safer than combination of pin and o-ring.



**Koken**





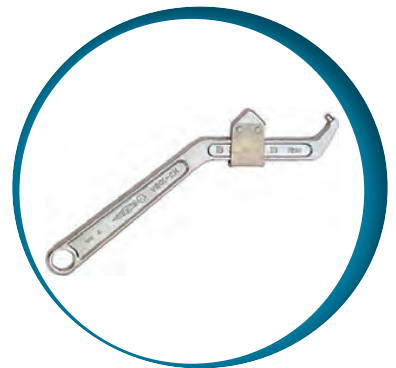

Founded in 1918 and still made  
in Japan.

Manufacturer of quality  
Ratcheting Podger Wrenches  
for use in the rigging and  
scaffolding markets



PART NO.	ITEM	DESCRIPTION	BARCODE	IMAGE	
<b>PODGERS</b>					
<b>SCAFFOLDING PODGER</b>					
SRB2124	508211	SCAFFOLDING PODGER 21X23.5MM STUBBY Specifically designed to fit Australian Scaffold Fittings	4967521175913		
<b>OFFSET PODGER RING SPANNERS</b>					
Single offset ring podger wrench 60 degree angle head. Heavy Duty Professional Type					
SRKP19	508229	OFFSET PODGER RING SPANNER 19MM	4967521017923		
SRKP22	508230	OFFSET PODGER RING SPANNER 22MM	4967521017947		
SRKP24	508231	OFFSET PODGER RING SPANNER 24MM	4967521017961		
SRKP27	508232	OFFSET PODGER RING SPANNER 27MM	4967521017985		
SRKP30	508233	OFFSET PODGER RING SPANNER 30MM	4967521017992		
SRKP32	508234	OFFSET PODGER RING SPANNER 32MM	4967521018005		
SRKP36	508235	OFFSET PODGER RING SPANNER 36MM	4967521018029		
SRKP41	508236	OFFSET PODGER RING SPANNER 41MM	4967521018036		
SRKP46	508237	OFFSET PODGER RING SPANNER 46MM	4967521018043		
SRKP50	508238	OFFSET PODGER RING SPANNER 50MM	4967521018050		



**Cation paint**

◆ Super Tool developed and sold the single offset wrench with 60 degree-slanted necks and handles with spears end in 1957.

Highly regarded for use on construction sites. This wrench was used for antenna installation on Tokyo tower.

**KP 13 ~60**

- The drop-forged I beam structure of the handle section provides strength and stability.
- The corn shaped spear part is optimal for aligning bolt holes.
- 60 degree-slant and length of the neck part prevents collision with adjacent bolts or angle ribs.
- Optimal for civil engineering, construction, bridging and steel towering.

(Excellent rust proofing)

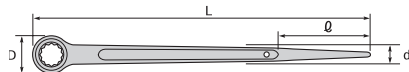
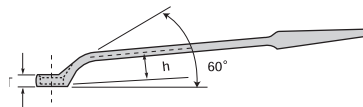
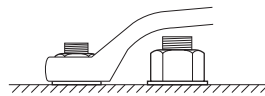

For sizes above 17, a hole for attaching a safety rope is provided



PART NO.	ITEM	DESCRIPTION	BARCODE	IMAGE
<b>RATCHET PODGER WRENCH</b>				
The ratchet wrenches are used for tightening and loosening nuts and bolts and the spear is used to align the position of the bolts holes at work sites such as those on the steel structures, towers and bridge beams. As there is no danger of the socket falling off, the ratchet wrench works well especially in the civil engineering and construction industries where workers are assembling scaffold at heights. The ratchet wrench can be turned clockwise or counter-clockwise. The end of the handle is designed to be spear-like. Wrenches are Cation plated which provides excellent rust proofing properties.				
SRRN1924R	508264	RATCHET PODGER WRENCH 19 x 24MM	4967521025188	
SRRN1012	508253	RATCHET PODGER WRENCH 10 x 12MM	4967521024921	
SRRN1317	508256	RATCHET PODGER WRENCH 13 x 17MM	4967521024990	
SRRN1618	508257	RATCHET PODGER WRENCH 16 X 18MM	4967521174855	
SRRN1719	508258	RATCHET PODGER WRENCH 17 x 19MM	4967521025034	
SRRN1824	508260	RATCHET PODGER WRENCH 18X24MM	4967521253215	
SRRN1921	508262	RATCHET PODGER WRENCH 19 x 21MM	4967521025102	
SRRN2427	508267	RATCHET PODGER WRENCH 24 x 27MM	4967521025249	
SRRN2124	508265	RATCHET PODGER WRENCH 21 X 24MM	4967521167314	
SRRN2224	508266	RATCHET PODGER WRENCH 22 X 24MM	4967521025225	
SRRN2430	508268	RATCHET PODGER WRENCH 24 x 30MM	4967521025263	
SRRN2730	508270	RATCHET PODGER WRENCH 27 x 30MM	4967521025294	
SRRN2732	508271	RATCHET PODGER WRENCH 27 x 32MM	4967521025300	
SRRN3036	508272	RATCHET PODGER WRENCH 30 x 36MM	4967521086943	
SRRN3236	508274	RATCHET PODGER WRENCH 32 x 36MM	4967521025348	
SRRN3641	508275	RATCHET PODGER WRENCH 36 x 41MM	4967521025362	
SRRN4650	508276	RATCHET PODGER WRENCH 46 x 50MM	4967521025386	



**Cation paint**  
(Excellent rust proofing)

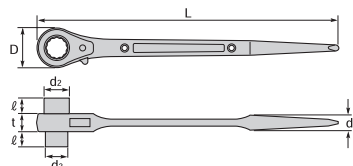

- The opening of the socket for change over of the reversible type enables easy cleaning of sand and dirt, etc.
- 34 sizes of double socket type (Reversible claw type) are available to cover a variety of uses.
- Lubricate before use.

Safety rope holes are provided on sizes 13X19 • 17X19 and above. (17X19, 17X21 and 19X21 have 2 holes)



SRRNG1924	508280	RATCHET PODGER 19 x 24MM WITH RUBBER GRIP	4967521024648	
SRRNG2430	508281	RATCHET PODGER 24 X 30MM WITH RUBBER GRIP	4967521024723	

### RUBBER GRIPS

Special oil resistant grip designed for use with podger wrenches.

SRRG4	508245	RUBBER GRIP #RG-4, SUITS 17x19, 16x18, 19x21mm	4967521022965	
SRRG5	508246	RUBBER GRIP #RG-5, SUITS 21x24, 22x24mm	4967521022996	
SRRG6	508247	RUBBER GRIP #RG-6, SUITS 24x30, 27x30, 27x32 30x36, 32x36mm	4967521023009	
SRRG8	508248	RUBBER GRIP #RG-8, SUITS 36x41, 46x50mm	496752102016	





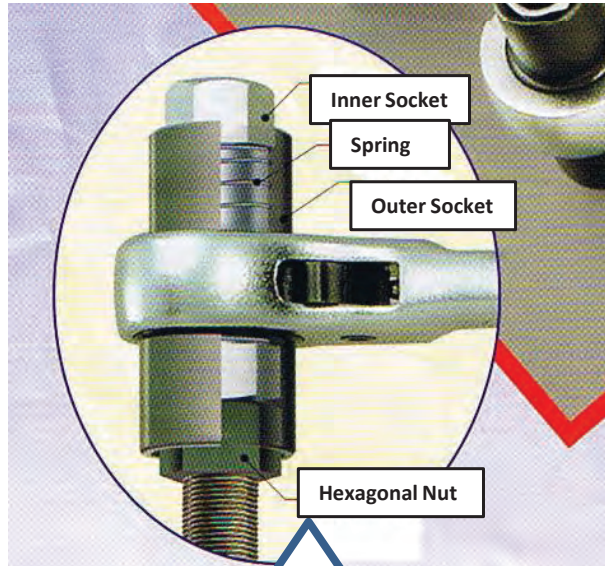

PART NO.	ITEM	DESCRIPTION	BARCODE	IMAGE
<b>STUBBY RATCHET PODGER</b>				
SRF-1	508223	RATCHET PODGER 4-SIZE 10X14, 13X17 STUBBY	4967521297622	
SRF-3	508224	RATCHET PODGER 4-SIZE 17X21, 19X24 STUBBY	4967521297646	

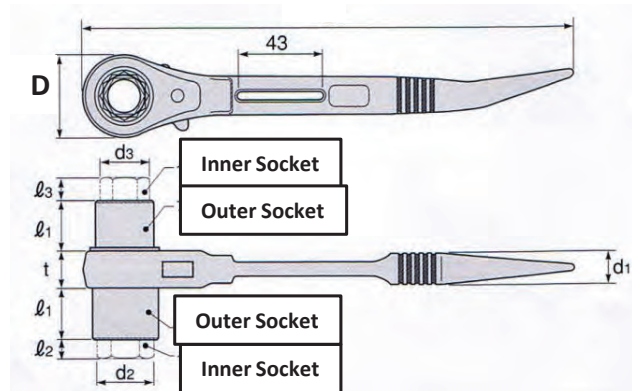

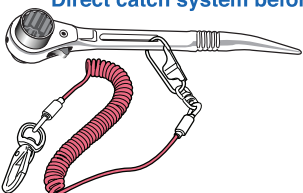
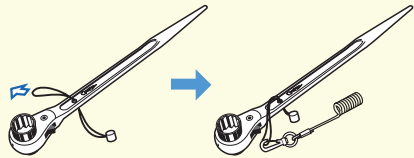
When outer socket is used, inner socket is pushed up easily, and after the use, the inner socket returns to the original position by spring.





PART NO.	ITEM	DESCRIPTION	BARCODE	IMAGE
<b>PODGER ACCESSORIES</b>				
<b>RUBBER GRIPS</b>				
Special oil resistant grip designed for use with podger wrenches.				
SRRG4	508245	RUBBER GRIP #RG-4, SUITS 17x19, 16x18, 19x21mm	4967521022965	
SRRG5	508246	RUBBER GRIP #RG-5, SUITS 21x24, 22x24mm	4967521022996	
SRRG6	508247	RUBBER GRIP #RG-6, SUITS 24x30, 27x30, 27x32 30x36, 32x36mm	4967521023009	
SRRG8	508248	RUBBER GRIP #RG-8, SUITS 36x41, 46x50mm	496752102016	
<b>SAFETY ROPE</b>				
<div style="display: flex; justify-content: space-between; align-items: flex-start;"> <div style="width: 45%;"> <p><b>SAFETY ROPE (To prevent tools from falling at heights)</b></p> <ul style="list-style-type: none"> <li>● Controlable in length and flexible coiled rope.</li> <li>● Applicable for any tool which has safety holes Ex.ratchet wrenches and adjustable angle wrenches.</li> <li>● Falling loads up to 1kg of weight per tool.</li> </ul> </div> <div style="width: 45%; text-align: center;"> <p><b>Direct catch system before</b></p>  </div> <div style="width: 45%; text-align: center;"> <p><b>The way to connect</b></p> <p><b>In case of using the connecting wire</b></p>  </div> </div>				
SRARK-10K	508208	SAFETY ROPE FOR RATCHET PODGER WRENCHES	4967521297097	
<b>PODGER HOLSTER</b>				
SRRHD7	508252	RATCHET PODGER HOLSTER FOR SCAFFOLDER/RIGGERS	4967521240093	

PART NO.	ITEM	DESCRIPTION	BARCODE	IMAGE
<b>HAND TOOLS</b>				
<b>HOOK SPANNERS</b>				
Hook spanner for circular nuts. Designed for tightening and removing notched circular nuts without damage to the nut. Nickel-Chrome plated finish				
SRHW105	508226	HOOK SPANNER ADJUSTABLE 35-105MM	4967521017633	
SRHW165	508228	HOOK SPANNER ADJUSTABLE 95-165MM	4967521017657	
<b>PIN SPANNERS</b>				
SRPW100	508242	<b>PIN SPANNER ADJUSTABLE 18-100MM PITCH</b> Pin spanner for circular nuts. Designed to be hammered at the moving part. Designed for tightening and removing circular nuts with pin holes. Body Nickel-Chrome plated finish, other parts in phosphoric acid manganese film forming treatment. Pin Diameter 5mm x 7mm & Pin Diameter 6mm x 8mm	4967521022712	

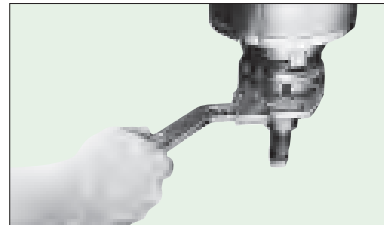
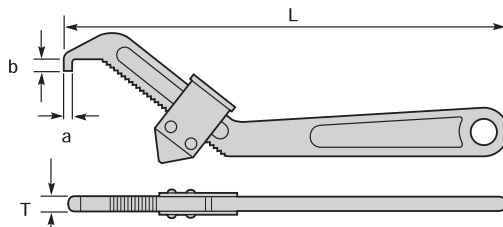

SRHW105A	508227	<b>PIN SPANNER 6MM DIAMETER PIN ADJUST 35-105MM</b> Hook spanner for circular nuts. Designed for tightening and removing notched circular nuts without damage to the nut. Nickel-Chrome plated finish	4967521017640	
----------	--------	--	---------------	--



SRPW100/RKA	508243	SPARE PINS SUITS PW100 "A" (2 PER SET)	4967521022729	
SRPW100/RKB	508244	SPARE PINS SUITS PW100 "B" (2 PER SET)	4967521022736	

<b>RATCHETING ADJUSTABLE WRENCH</b>				
SRMWR30	508240 <sup>^</sup>	RATCHETING ADJUSTABLE WRENCH 200MM X 30MM MAX.	4967521301343	
SRMWR36	508241 <sup>^</sup>	RATCHETING ADJUSTABLE WRENCH 250MM X 36MM MAX.	4967521301350	



# VBW

## QUALITY PLIERS



### HARD WEARING

VBW Pliers & Cutters are all made from specially selected high-quality steels and forged in house.

### TOUGH

VBW Pliers are hardened in an oil bath and all cutting edges are additionally induction hardened.

### PRECISION

VBW Pliers & Cutters have precision jaws and cutting edges.

### COMFORTABLE

VBW Pliers & Cutters have handles specially designed to fit firmly in the hand and distribute the force evenly.

### SAFETY

VBW Pliers & Cutters are designed to take the "effort" out of work and guarantee safe working. VBW Cutters will cut right to the tips, grip even the finest wires, deal equally efficiently with oily steel sheets and heavy work pieces, all with minimum effort.











**100% Made in Germany**  
*from the Blank to the Finished Pliers*



**VBW** 

is a wholly owned  
subsidiary of









PART NO.	ITEM	DESCRIPTION	BARCODE	IMAGE
<b>PLIERS</b>				
<b>531 CIRCLIP INNER STRAIGHT</b>				
		DIN 5256 Chrome-vanadium, drop forged, oil-hardened, precision non-slip tips. Polished with dip-coated handles		
VB531620	710576	CIRCLIP PLIER INNER 85-140MM Length: 320mm DIN Size: C85 Size: J4	4005887523501	
<b>532 CIRCLIP INNER 90° TIP</b>				
		DIN 5256 Chrome-vanadium, drop forged, oil-hardened, precision non-slip tips. Polished with dip-coated handles		
VB532125	710581	CIRCLIP PLIER INNER 85-140MM BENT Length: 290mm DIN Size: D85 Size: J41	4005887004550	
<b>533 CIRCLIP EXTERNAL STRAIGHT SPRING LOADED</b>				
		DIN 5254 Chrome-vanadium, drop forged, oil-hardened, precision non-slip tips. For circlips on shafts etc. Polished with dip-coated handles		
VB533660	710586	CIRCLIP PLIER OUTER 85-140MM Length: 325mm DIN Size: A85 Size: A4	4005887524409	
<b>545 COMBINATION PLIER</b>				
		DIN ISO 5746 High grade tool steel with excellent cutting force and durability. Induction hardened (app. 64 HRC) precision cutters for all wire types, including piano wire.		
VB545315	710602	COMBINATION PLIER 200MM SOFT ZONE HANDLES Hard 48 HRc Max: 2.5mm Piano 59HRc Max: 2.0mm	4005887004765	
VB587225	710650	SIDE CUTTER PLIER 180MM SOFT ZONE HANDLES Soft 19 HRc Max: 3.8mm Med 40HRc Max: 3.0mm Hard 48 HRc Max: 2.5mm Piano 59HRc Max: 2.0mm	4005887005915	
<b>588 SIDE CUTTER PLIER - HEAVY DUTY</b>				
		DIN ISO 5749 Type A, induction hardened (approx. 64 HRC) precision cutters for all wire types, including piano wire.		
VB588215	710664	SIDE CUTTER PLIER 200MM H/DUTY SOFT ZONE HANDLES Soft 19 HRc Max: 4.0mm Med 40HRc Max: 4.0mm Hard 48 HRc Max: 3.0mm Piano 59HRc Max: 2.5mm	4005887005991	
VB588220	710665	SIDE CUTTER PLIER 250MM H/DUTY SOFT ZONE HANDLES Soft 19 HRc Max: 4.0mm Med 40HRc Max: 4.0mm Hard 48 HRc Max: 3.5mm Piano 59HRc Max: 3.0mm	4005887006004	
<b>524 SNIPE NOSE PLIER</b>				
		DIN ISO 5745 Straight, half-rounded, long tapered serrated jaws with concave grip section for holding nuts and gudgeons (straight pins). Induction hardened (approx 60 HRC) precision cutters for soft and hard wire.		
VB524205	710560	SNIPE NOSE PLIER 200MM SOFT ZONE HANDLES	4005887004383	
<b>PLIER SETS</b>				
VB80P	710705	PLIER SET 3 PIECE - COMB, SIDE, SNIPE Polished with soft zone handles Contains: 180mm Combination Pliers 160mm Side Cutter 200mm Snipe Nose (long nose) Pliers	4005887010445	
VB777	710688	PLIER SET 4 PCE - CIRCLIP J2 J21 A2 A21 POLISHED WITH DIP-COATED HANDLES Contains: 180mm Circlip Pliers for internal circlips with straight tip (19-60mm) J2 170mm Circlip Pliers for internal circlips with 90° tip (19-60mm) J21 180mm Circlip Pliers for external circlips with straight tip (19-60mm) A2 170mm Circlip Pliers for external circlips with 90° tip (19-60mm) A21	4005887006714	

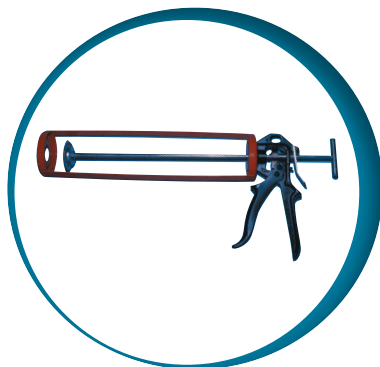

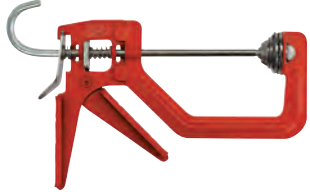
**Svenic Australia offers a comprehensive range of British made quality Sealant and Adhesive Application Equipment.**

**Svenic is Australasia's leading supplier of dispensing equipment for the application of Sealants, Adhesives and Coatings.**



PART NO.	ITEM	DESCRIPTION	BARCODE	IMAGE
<b>CLAMPS</b>				
<b>SOLO CLAMP</b>				
<p>Powerful, high thrust mechanism, enables jaws to be quickly and securely locked onto the job with just one hand. Quick release of Clamping Force by simply pressing down with thumb on release plate. Strong, lightweight, quality construction ensures reliability. Increased working life due to heat treated moving parts. Proven and simple mechanism ensures trouble free use. Specially designed, grooved metal and nylon jaws clamp most objects, including pipe. All steel frame and trigger mechanism</p>				
SVSC100M	508421	SOLO CLAMP 100MM METAL FEET QUICK ACTION	9313863000119	
SVSC150M	508423	SOLO CLAMP 150MM METAL FEET QUICK ACTION	9313863000133	
SVSC100N	508422	SOLO CLAMP 100MM NYLON FEET QUICK ACTION	9313863000010	
SVSC150N	508424	SOLO CLAMP 150MM NYLON FEET QUICK ACTION	9313863000126	
<b>CAULKING GUNS</b>				
<b>HANDY</b>				
<p>Low cost, quality applicator – a must for the price conscious customer. Powerful, high thrust mechanism dispenses most materials easily. Made from impact and fracture resistant Plastic which does not corrode. Comfortable operation due to lightweight frame and contoured trigger. Cartridge support ring adds strength, holds cartridge in place during operation and when changing cartridge. Suitable for small, medium and large stores Dispenses 300 ml cartridges of silicone, acrylic, timber adhesive, mastic and caulk</p>				
SV600SAE	508376	CAULKING GUN HANDY 215MM BLACK PLASTIC APPLICATOR	9313863016004	
<b>TRADE</b>				
<p>Strong, lightweight, quality steel construction ensures reliability. Superior spot welds prevent the end ring “popping off” under high pressure. Premium epoxy powder coating resists corrosion. Heat treated moving parts, increases working life. Suitable for small, medium and large stores with Handymen, Trade and Professional users. Dispenses 300 ml cartridges of silicone, acrylic, timber adhesive, mastic and caulk</p>				
SV608SAE	508379	CAULKING GUN TRADE 215MM (YELLOW) APPLICATOR	9313863016080	
<b>PRO GUN - 2</b>				
<p>Strong, lightweight, quality construction, ensures reliability. Minimal wasted trigger action and increased working life. Comfortable operation due to smooth, effortless action, contoured trigger and balanced design. Made from impact and fracture resistant, reinforced nylon. Cartridge support ring adds strength, holds cartridge in place during operation and when changing cartridges. Cheap and inferior Copies can result in operator injury and customer dissatisfaction. Hanging hook enhances safety and convenience as applicator can be hung from the ladder, gutter, belt, etc. Dripless function releases pressure from cartridge automatically. Suitable for Medium to Large stores. A must for Tradesmen and Professional customers. Dispenses 300 ml cartridges of silicone, acrylic, timber adhesive, Polyurethane, mastic and caulk</p>				
SV614SAE	508380	CAULKING PRO GUN 2 ORANGE 215MM NYLON - H.DUTY	9313863016141	
<b>PRO GUN - SV616SAE</b>				
<p>Strong, lightweight, metal construction, ensures reliability. Minimal wasted trigger action and increased working life. Comfortable operation due to smooth, effortless action, contoured trigger and balanced design. Premium epoxy powder coating resists corrosion. Cheap and inferior Copies can result in operator injury and customer dissatisfaction. Superior spot welds prevent the end ring “popping off” under high pressure. Hanging hook enhances safety and convenience as applicator can be hung from the ladder, gutter, belt, etc. Dripless function releases pressure from cartridge automatically. Suitable for Medium to Large stores. A must for Tradesmen and Professional customers. Dispenses 300 ml cartridges of silicone, acrylic, timber adhesive, mastic and caulk, Polyurethane and High Viscosity Materials</p>				
SV616SAE	508381	CAULKING PRO GUN ORANGE 215MM SEALANT APPLICATOR	9313863016165	
<b>HEAVY DUTY HV FRAME GUN</b>				
<p>Top of the range, professional quality applicator. Easily dispenses hard or difficult sealants, caulks and adhesives, due to its high mechanical advantage. Especially suited to Polyurethanes. Operator efficiency is enhanced by the effortless trigger action which allows for smooth, full strokes. Balanced design and profiled hand grip provide for comfortable use by all hand sizes. Superior spot welds prevent the end ring “popping off” under high pressure. Thick, patented catchplate, hardened push rod, and robust construction ensure reliability and increased working life. Suitable for Medium and Large stores with Trade and Professional customers. Dispenses 300 ml cartridges</p>				
SV620SAE	508383	CAULKING GUN HEAVY DUTY 215MM APPLICATOR	9313863016202	
<b>JUMBO SEALANT APPLICATOR</b>				
<p>Top of the range, professional quality applicator. Easily dispenses hard or difficult sealants, caulks and adhesives, due to its high mechanical advantage. Operator efficiency is enhanced by the effortless trigger action which allows for smooth, full strokes. Balanced design and profiled hand grip provide for comfortable use by all hand sizes. Superior spot welds prevent the end ring “popping off” under high pressure. Thick, patented catchplate, hardened push rod, and robust construction ensure reliability and increased working life. Suitable for Medium and Large stores with Trade and Professional Customers. Dispenses 850 ml cartridges</p>				
SV625SAE	508388	CAULKING GUN JUMBO 320MM SEALANT APPLICATOR	9313863016257	

PART NO.	ITEM	DESCRIPTION	BARCODE	IMAGE
<b>BARREL APPLICATORS - HAND OPERATED for SACHETS &amp; CARTRIDGES ONLY</b>				
<p>Barrel Sealant Applicator - Hand operated for Bulk Material only. Easily dispenses any hard or difficult sealants, caulks and adhesives, due to its high mechanical advantage. Operator efficiency is enhanced by the effortless trigger action, which allows for smooth, full strokes. Balanced design and profiled hand grip provide for comfortable use by all hand sizes. Quick release end cap reduces refilling time thus increasing user efficiency. Wearing parts are replaceable. Swivel frame allows for continuous beading without changing the angle of the trigger. Plastic plunger gives a clean sweep within the drawn barrel thus preventing the sachet gathering behind the plunger during operation. Nozzle holder accepts standard nozzles or nozzles made from 3/4 inch gas pipe. Thick, patented catchplate, hardened push rod, and robust construction, ensure reliability and increased working life.</p> <ul style="list-style-type: none"> <li>• Lightweight Aluminium or plastic barrel</li> <li>• operator efficiency is enhanced by the effortless trigger action which allows for smooth full strokes.</li> <li>• Balanced design and profiled hand grip provide for comfortable use by all hand sizes.</li> <li>• Quick release end cap reduces refilling time thus increasing user efficiency.</li> <li>• Wearing parts are replaceable.</li> <li>• Plastic plunger gives a clean sweep within the drawn barrel thus preventing the sachet gathering behind the plunger during operation.</li> <li>• Thick, patented catchplate, hardened push rod, and robust construction, ensure reliability and increased working life.</li> </ul>				
SV660SAE	508390	30CM ALUMINIUM BARREL SEALANT GUN with nozzle holder	9313863021152	
SV676SAE	508394	37CM ALUMINIUM BARREL SEALANT GUN without nozzle holder • Supplied with 2 opaque cone nozzles • Dispenses 600ml sachets or 300ml cartridges • 12:1 gearing for higher viscosity sealants	9313863023903	
SV678SAE	508395	37CM ALUMINIUM BARREL SEALANT GUN with nozzle holder • 25:1 gearing for high viscose materials • 600ml, for cartrides or sachets	9313863021299	
SV671SAE	508393	CAULKING GUN BARREL SEALANT 37CM APPLICATOR FOR BULK MATERIAL	9313863021220	
SV681SAE	508396	CAULKING GUN BARREL SEALANT 45CM APPLICATOR FOR BULK MATERIAL	9313863021329	
<b>SPARE NOZZLES</b>				
SV076HSAE	508316	OPAQUE PLASTIC NOZZLE FOR BARREL GUNS WITHOUT NOZZLE HOLDERS		
SV7N1529	508318	GREY PLASTIC NOZZLE FOR BARREL GUNS WITH NOZZLE HOLDERS		
SV380SAE	508353	PLASTIC NOZZLES FOR BARREL GUNS WITH & WITHOUT NOZZLE HOLDERS (5 ASSORTED NOZZLES)	9313863019531	

PART NO.	ITEM	DESCRIPTION	BARCODE	IMAGE
<b>TUCK POINTING GUN</b>				
<p>Specialist tool for applying pointing mortars and grouts. Developed for repointing brick and masonry joints, the pointing and grouting gun is now supplied with a second nozzle for filling fine joints and tile-grouting. Easy to Use: The Pointing and Grouting Gun is designed for effortless dispensing with a powerful, 12:1 trigger mechanism and ergonomically contoured hand grips. Also, a robust steel and aluminium construction with case hardened drive components provide strength and durability. Simply fill the jointing material into the open end of the barrel and then dispense it through the nozzle. High Quality Joints: Injecting the grout deep into the joint provides a superior finish with reduced possibility of voids. Applying the grout where you want it results in less mess, less waste and much shorter cleaning times. Note: Mortars containing "sharp sand" or coarse aggregates will not flow under pressure. Use only free-flowing or specialty mortars that contain high grade, "soft" sand. Alternatively ask Svenic about our specially designed grouts for the pointing gun. Product features: Barrels made from plastic for inexpensive replacement. Choice of taper fit nozzles - black for pointing and other wide joints; grey for tile grouting and narrow joints. Rubber plunger sandwiched between steel washers is adjustable for optimum fit in barrel. High thrust trigger mechanism with contoured hand grips provide easier dispensing and reduced operator fatigue. Patented Wear Compensating Device eliminates free-play in trigger for 100% working action throughout the life of the gun. Plunger rod and other drive components are case hardened for long life. Projection welded steel frame, finished in tough epoxy paint finish for high strength, durability and corrosion resistance.</p>				
SV685SAE	508400	CAULKING GUN 32CM TUCK POINTING (MORTAR)	9313863021367	
SV2N1030	508363	BLACK PLASTIC NOZZLE FOR SV685SAE TUCK POINTING GUN		
SV2N1042	508366	GREY PLASTIC NOZZLE FOR SV685SAE TUCK POINTING GUN		
SV2B4001	508364	PLASTIC BARREL FOR SV685SAE TUCK POINTING GUN		

# POINTING & GROUTING GUN















<b>AIR APPLICATOR FOR CARTRIDGES</b>				
<p>Suitable for 300ml cartridges. Dispenses small rigid cartridges only. Standard models dispense 215 mm and 250 mm cartridge lengths. Air acts directly against cartridge plunger. Strong trigger made of lightweight engineering plastic contoured for comfortable operation. Pressure regulator secured below trigger handle, providing zero to maximum pressure control, with a responsive half a turn of the regulator knob. A silencer fitted to the quick exhaust valve provides much quieter operation. Continuous A-weighted sound pressure levels now well below the 70dB mark. Air hose connector rotates and swivels for maximum freedom of movement. Quick release end cap increases user efficiency. 50 mm diameter aluminium barrel. Lightweight barrel and balanced design provides for comfortable operation. Nozzle holder accepts standard nozzles or nozzles from 3/4 inch gas pipe.</p>				
SV712SAE	508402	CAULKING CARTRIDGE AIR GUN 215MM APPLICATOR WITH REG.	9313863021435	

<b>AIR APPLICATOR FOR SACHETS (SAUSAGES)</b>				
<ul style="list-style-type: none"> <li>• Dispense 300mm and 370mm sachets (sausages), eg 400ml and 600ml in volume</li> <li>• Air acts directly against the free floating plunger which is secured by a cord for safety.</li> <li>• Strong trigger made of lightweight engineering plastic contoured for comfortable operation</li> <li>• Pressure regulator secured below trigger handle, providing zero to maximum pressure control, with a responsive half a turn of the regulator knob.</li> <li>• A silencer fitted to the quick exhaust valve provides much quieter operation. Continuous A-weighted sound pressure levels now well below the 70dB mark.</li> <li>• Air hose connector rotates and swivels for maximum freedom of movement.</li> <li>• Quick release end cap increases user efficiency.</li> <li>• 50mm diameter aluminium barrel</li> <li>• Lightweight barrel and balanced design provides for comfortable operation.</li> <li>• Can be modified to dispense Pourable materials and Collapsible cartridges.</li> <li>• Nozzle holder accepts standard nozzles or nozzles for 3/4" gas pipe.</li> </ul>				
SV742SAE	508408	CAULKING CARTRIDGE AIR GUN 37CM SERIES 2 SACHET	9313863021541	

Maun Industries have developed a wide range of pliers for general use as well as a host of specialist applications. Compound lever and parallel action pliers have pressed steel handles and machined jaws. Compound lever pliers have high mechanical advantage and are unsurpassed as wire cutters. The unique feature of parallel action pliers is that the jaws close parallel to each other, making the pliers an ideal starting point for many specialist applications, especially fencing.



PART NO.	ITEM	DESCRIPTION	BARCODE	IMAGE
<b>PLIERS</b>				
<b>END CUTTING</b>				
The compound lever design of the end cutting nipper gives excellent cutting performance with low handle load. This is ideal for the repetitive cutting operations encountered in spring and bedding production.				
MA3010/150	506012	END CUTTING 150MM NIPPER, Plain Handle	5018695000491	
MA3015/150	506013	END CUTTING 150MM NIPPER PVC hand grips	5018695000637	
<b>PARALLEL</b>				
MA4866/160	506018 <sup>^</sup>	<b>PARALLEL PLIER 160MM KNURLED JAWS PVC GRIP</b> Flat nose parallel action plier, knurled jaws and wire groove. PVC grips	5018695001160	
MA4870/125	506019	<b>PARALLEL PLIER 125MM SMOOTH JAWS</b> Flat nose parallel action pliers, sealed handles, smooth jaws	5018695000545	
MA4870/140	506020	<b>PARALLEL PLIER 140MM SMOOTH JAWS</b> Flat nose parallel action pliers, sealed handles, smooth jaws	5018695000842	
MA4870/160	506021	<b>PARALLEL PLIER 160MM SMOOTH JAWS</b> Flat nose parallel action pliers, sealed handles, smooth jaws	5018695000859	
MA4871/140	506022	<b>PARALLEL PLIER 140MM SMOOTH JAWS SPRING RETURN</b> Flat nose parallel action pliers, sealed spring return handles, smooth jaws	5018695000866	
MA4951/140	506024 <sup>^</sup>	<b>PARALLEL ACTION PLIER 140MM WITH SIDE CUTTER PLAIN HANDLE</b> Side cutting plier spring return handles, also with knurled parallel action plier jaws and wire groove. Cuts up to 1.6mm hard wire, 2.0mm soft wire.	5018695000552	
MA4951/160	506025	<b>PARALLEL ACTION PLIER 160MM WITH SIDE CUTTER PLAIN HANDLE</b> Side cutting plier spring return handles, also with knurled parallel action plier jaws and wire groove. Cuts up to 1.6mm hard wire, 2.0mm soft wire.	5018695000446	
MA4950/200	506023	<b>PARALLEL ACTION PLIER 200MM WITH SIDE CUTTER PLAIN HANDLE</b> side cutting plier, also with knurled parallel action plier jaws and wire groove with PVC grip. Cuts up to 1.6mm hard wire, 2.0mm soft wire.	5018695000514	
MA4960/200	506027	<b>PARALLEL ACTION PLIER 200MM W/SIDE CUTTER PVC HANDLE</b> Side cutting plier, also with knurled parallel action plier jaws and wire groove. Cuts up to 1.6mm hard wire, 2.0mm soft wire. <b>Ideal for Fencing</b>	5018695000408	
<b>DIAGONAL</b>				
MA2990/160	506009	<b>DIAGONAL CUTTING PLIER 160MM PLAIN HANDLE</b> Side cutting pliers, with spring return plain handle. Cuts up to 2mm hard wire.	5018695000576	
<b>REVOLVING PUNCH</b>				
MA2230/200	506005	<b>REVOLVING PUNCH PLIER 200MM(2.0-4.8MM) LEATHER</b> Punches holes 2.0, 2.4, 2.8, 3.2, 4.0 & 4.8mm. Plated, plain grip.	5018695000415	
MA2233-200	506006	<b>REVOLVING PUNCH PLIER 200MM LEVER ASSIST</b> Lever assisted revolving punch plier. Punches holes 2.0, 2.4, 2.8, 3.2, 4.0 & 4.8mm. Plated, P.V.C. handle.	5018695001429	

PART NO.	ITEM	DESCRIPTION	BARCODE	IMAGE	
<b>WAD PUNCHES</b>					
<b>WAD PUNCH KITS</b>					
These Kits comprise of a single handle onto which screw a series of nine interchangeable punches. The Handle and punches are fully heat treated and chemically blacked. The handle should be struck with a hammer or mallet onto a wooden block. The spring loaded plunger in the handle enables holes to be accurately centred and serves to eject the slug.					
MA1000/05	505987	WAD PUNCH KIT 10-PCS METRIC (5 - 32MM) Contains: 5, 6, 8, 10, 12.5, 16, 20, 25 and 32mm sizes	5018695000323		
MA1001/05	505990	WAD PUNCH KIT 10-PCS IMPERIAL (1/4 - 1") Contains: 1/4, 5/16, 3/8, 7/16, 1/2, 5/8, 3/4, 7/8 and 1" sizes	5018695000668		
<b>WAD PUNCH REPLACEMENTS</b>					
MA1000/005	505978	WAD PUNCH REPLACEMENT CUTTER 5MM	9313540108039		
MA1000/006	505979	WAD PUNCH REPLACEMENT CUTTER 6MM (1/4")	9313540108046		
MA1000/008	505980	WAD PUNCH REPLACEMENT CUTTER 8MM (5/16")	9313540108053		
MA1000/010	505981	WAD PUNCH REPLACEMENT CUTTER 10MM	9313540108060		
MA1001/438	505993	WAD PUNCH REPLACEMENT CUTTER 7/16"	9313540108145		
MA1000/125	505989	WAD PUNCH REPLACEMENT CUTTER 12.5MM	9313540108121		
MA1000/016	505982	WAD PUNCH REPLACEMENT CUTTER 16MM (5/8")	9313540108077		
MA1001/750	505995	WAD PUNCH REPLACEMENT CUTTER 3/4"	9313540108152		
MA1000/020	505983	WAD PUNCH REPLACEMENT CUTTER 20MM	9313540108084		
MA1001/875	505996	WAD PUNCH REPLACEMENT CUTTER 7/8"	9313540108169		
MA1000/025	505984	WAD PUNCH REPLACEMENT CUTTER 25MM (1")	9313540108091		
MA1000/032	505985	WAD PUNCH REPLACEMENT CUTTER 32MM	9313540108107		
MA1000/04	505986	WAD PUNCH ASSEMBLY HANDLE & CENTRE PUNCH	9313540108114		
<b>RULES</b>					
MA1774	506003	RULE 300MM SAFETY, NICKEL PLATED	9313540108190		
MA1700/500	506001	STEEL STRAIGHT EDGE 500MM	9313540108183		
MA1700/001	506000	STEEL STRAIGHT EDGE 1000MM	9313540108176		

# Maun Sealing Range







## SPECIALTY HAND TOOLS



**General Tools are known as the leader in innovative specialty hand tools.**

**General Tools manufacture quality hand tools that deliver outstanding value to millions of satisfied customers throughout the world.**



**General Tools has come to be respected for a broadly diversified line of hand tools in plumbing, woodworking, metalworking and machinist trades.**















### **WARRANTY:**







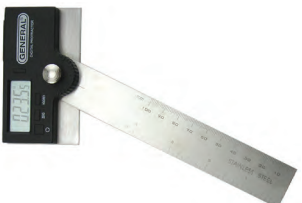

**Product is guaranteed against defective workmanship or material.**

#### **TERMS AND CONDITIONS**











*Our warranty commences from the date of purchase and is not transferable. The warranty only covers the original owner, purchaser or end user and is subject to the Trade Practices Act and Goods and Consumer Protection legislation of the various states. Proof of purchase along with appropriate documentations is required before consideration under warranty is given*







PART NO.	ITEM	DESCRIPTION	BARCODE	IMAGE
<b>BUILDERS TOOLS / WOODWORKING</b>				
<b>CIRCLE CUTTERS</b>				
GEN4	703124	<b>CIRCLE CUTTER 7/8 - 4" DIA. ECONOMY</b> Capacity: 22-100mm (7/8" - 4" diameter) Shank: 3/8" Round Replaceable high speed steel cutting blade and 1/4" pilot drill For use with drill press only. Maximum safe speed is 500 RPM All adjustments are made with the included hex wrench	038728210036	
GEN55	703130	<b>CIRCLE CUTTER 1 3/4 - 7 7/8" DIA. HEAVY DUTY</b> Capacity: 1 3/4" - 7 7/8" diameter Shank: 1/2" Round Replaceable high speed steel blade and 1/4" pilot drill For use with drill press only. Maximum safe speed is 500 RPM All adjustments are made with the included hex wrench Markings on beam for easy measurement	038728210128	
<b>WASHER &amp; GASKET CUTTERS</b>				
GEN11	703085	<b>WASHER &amp; GASKET CUTTER 5/8 - 6 1/2" DIA.</b> Capacity: 16-165mm (5/8" - 6 1/2" diameter) Combination round and square shank permits use with bit brace or hand drill. Suitable for washers and gaskets in leather, rubber, cork, graphite, fibre, copper and other soft materials. Graduated beam to adjust to required diameters. Replaceable cutter blades two independently adjustable cutter blades cut inside and outside diameters simultaneously.	038728210241	
<b>DRILL GRINDING ATTACHMENT</b>				
GEN825	703169	<b>DRILL GRINDING ATTACHMENT (3-19MM CAPACITY)</b> Engineered to permit sharpening of drill bits to factory accuracy. Extends the life of drill bits. Angle adjustments lock in to grind drill bits for more accurate drilling in a variety of materials. Automatically adjusts to give correct clearance angle. Capacity: 1/8" - 3/4", 3mm-19mm	038728240705	
<b>MEASURING / PRECISION</b>				
<b>RULERS</b>				
GEN300MM	703120	<b>RULE 150MM STAINLESS STEEL METRIC</b> 150mm flex, width 12mm, Grad: mm, 0.5mm	038728320414	
<b>PROTRACTORS</b>				
GEN16ME	703108	<b>MULTI RULE GAUGE STAINLESS STEEL</b> Stainless steel, Grad: 64th & mm	038728220158	
GEN17	703109	<b>PROTRACTOR SQUARE HEAD STEEL</b> General's heavy duty steel protractors are trusted by machinists and draftsmen worldwide to deliver crucial measurements with unwavering accuracy. The 6" adjustable arm is ideal for setting bevells, taking measurements and transferring angles. Ultra fine etched graduations read from 0 to 180° in forward and reverse directions, and will not wear or rub off. Made of ground stainless steel for precision and durability.	038728220189	
GEN18	703112	<b>PROTRACTOR ROUND HEAD STEEL</b>	038728220240	

PART NO.	ITEM	DESCRIPTION	BARCODE	IMAGE
GEN29	703116	<b>PROTRACTOR OUTSIDE, INSIDE, SLOPED ANGLE</b> Protractor/angle finder to measure and mark the degrees of an angle on outside, inside and sloped angles. Fine black graduations from 0° to 165° in opposite directions.	038728221483	
GEN822	800485	<b>PRO-ANGLE DIGITAL ANGLE RULE 5"</b> These new angle finders combine the ruggedness of analogue rulers (standard and metric) together with the digital technology needed for complete accuracy when measuring inside, outside and reverse angles. Precise measurements prevent waste by facilitating exact mitre cuts. One button activates the reverse angle function, a hold button digitally saves the measurement and the large ergonomic locking knob saves the angle manually. A large LCD readout makes measurements extremely easy to read while an innovative centre check notch enables exact ruler placement marking. The 822 (Patent Pending) is ideal for framing, custom furniture-building, stair and patio construction, flooring, tiling basically all woodworking, carpentry and contractor needs in the shop or in the field. <b>Features &amp; Benefits</b> <ul style="list-style-type: none"> <li>• Digital stainless steel angle rules make precise measurements for easy woodworking.</li> <li>• Calculates interior (inside) and exterior(outside) angles easily and accurately in seconds.</li> <li>• Measures both Metric and Imperial</li> <li>• Lock and reverse angle features for all types of work.</li> <li>• Large easy to read LCD display.</li> <li>• Hinge mechanism allows a full 360 degrees to measure inside/outside and reverse angles.</li> <li>• Can be zeroed at any point in the swing</li> <li>• Power Source:1 CR2032 3V Lithium battery (included)</li> </ul>	038728008220	 <b>NEW</b>
GEN1702	703111	<b>PROTRACTOR 6" DIGITAL</b> 6" (150mm) Stainless Steel digital protractor. Accuracy: 0.1° Resolution: 0.05° Range: 0.00° to 180.00° Hold function. Includes 1 X CR2023 (3V) Battery (Packaged: Blister)	038728260086	
GEN828	800484	<b>DIGITAL T BEVEL 0-360 DEGREES</b> The new Model 828 (Patent Pending) offers pioneering technology that takes the guesswork out of angle duplication and eliminates the problems associated with analogue readings and manual measurement transfer. Designed in-house by Generals engineering team, this is the first and only digital T-bevel on the market. It is ideal for measuring, storing and transferring inside and outside angles when building cabinetry, furniture and picture frames; installing tile and more. This highly accurate tool offers easy-to-read measurements via a large LCD display and integrates an 8" stainless steel blade with a steel locking knob. Practical function buttons make it ultra-convenient for setting and transferring measurements instantly. <b>Features &amp; Benefits</b> <ul style="list-style-type: none"> <li>• Tools in 1 - Digital Sliding T-Bevel and Protractor</li> <li>• Large digital angle readout</li> <li>• Holds measurement for transfers</li> <li>• Reverse Display button, Flip Display button, Locking Knob for manual measurement transfer function control button</li> <li>• Auto Shut off feature</li> <li>• 8" Stainless Steel blade</li> <li>• Impact resistant ABS handle</li> <li>• Full LCD Display</li> <li>• Measures and transfers angles, Range: 0-360, Resolution: .05, Accuracy: 0.3</li> <li>• Voltage: DC 2.5V-3.2V Power Source:1 CR2032 3V Lithium battery (included)</li> </ul>	038728082800	 <b>NEW</b>

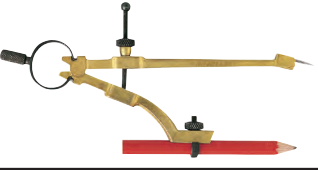
PART NO.	ITEM	DESCRIPTION	BARCODE	IMAGE
<b>CENTRE PUNCH</b>				
GEN77	703156	<b>CENTRE PUNCH 127MM AUTOMATIC ALUMINIUM</b> Unique ball bearing action, lightweight body Long wearing alloy steel parts. Body diameter 16mm (5/8"). O/A Length 127mm (5")	038728310620	
GEN87	703176	<b>CENTRE PUNCH AUTOMATIC POCKET SIZED</b> Pencil-sized Pocket Centre Punch (Packaged: Carded)	038728311085	
<b>DIVIDER</b>				
GEN450-6	703125	<b>FLAT LEG DIVIDER 159MM MAX MEASURING WIDTH</b> Max measuring width 159mm Legs are forged of special caliper steel Hardened and tempered bow springs Hardened points	038728316011	
<b>CALIPERS</b>				
GEN454-6	703127	<b>INSIDE CALIPER 165MM MAX MEASURING WIDTH</b> Max measuring width 165mm Legs are forged of special caliper steel Hardened and tempered bow springs Hardened points	038728316394	
GEN452-6	703126	<b>OUTSIDE CALIPER 160MM MAX MEASURING WIDTH</b> Max measuring width 160mm Legs are forged of special caliper steel Hardened and tempered bow springs Hardened points	038728316189	
<b>DIGITAL FRACTIONAL CALIPERS</b>				
GEN146	703095	<b>DIGITAL FRACTIONAL CALIPER 0-150MM CARBON FIBRE</b> Three universal measurement systems Inches, mm and fractions Accuracy to 0.2 mm ( 0.08") Lightweight, carbon fibre Inside, outside, step and depth measurements Resolution: 0.0005", 1/64" Extendable depth gauge Auto off feature Replacement Battery - LR44 High-contrast, tri-mode digital display Resolution: 0.01mm, 0.0005", 1/64" (Packaged: Plastic Box)	038728014603	
GEN1478C	703100	<b>DIGITAL FRACTIONAL CALIPER 0-200MM</b> Inches, mm and fractions Accuracy to 0.03 mm ( 0.0012") Rugged stainless steel design Inside, outside, step and depth measurements Resolution: 0.01mm, 0.0005" 1/64" Extendable depth gauge Auto off feature Replacement Battery - LR44 Calibration certificate included (Packaged: Plastic Box)	8901486160016	
GEN147C	703101	<b>DIGITAL FRACTIONAL CALIPER 0-150MM</b> Inches, mm and fractions Accuracy to 0.02 mm ( 0.001") Rugged stainless steel design Inside, outside, step and depth measurements Resolution: 0.01mm, 0.0005" 1/64" Extendable depth gauge Auto off feature Replacement Battery - LR44 Calibration certificate included (Packaged: Plastic Box)	8901486160009	

**GENERAL**

PART NO.	ITEM	DESCRIPTION	BARCODE	IMAGE
<b>VERNIER CALIPERS</b>				
GENMG6001C	703194	<b>VERNIER CALIPER 0-150MM RESOLUTION 0.02MM</b> Vernier scale etched with permanent black graduations Extendable depth gauge Resolution: 0.02mm (0.001") Accuracy: +/-0.02mm (+/-0.001") (Packaged: Plastic Box)	8901486160405	
GENMG8001C	703195	<b>VERNIER CALIPER 0-200MM RESOLUTION 0.02MM</b> Vernier scale etched with permanent black graduations Extendable depth gauge Resolution: 0.02mm (0.001") Accuracy: +/-0.03mm (+/-0.0012") (Packaged: Plastic Box)	8901486160412	
<b>DIAL CALIPERS</b>				
GENMGDC150C	703196	<b>DIAL CALIPER 0-150MM RESOLUTION 0.02MM</b> Hardened stainless steel with deep etched graduations Large, clear dial gauge Resolution: 0.02 mm Accuracy: +/-0.02mm Inside, outside, depth & step measurements Adjustable bezel for zero setting Calibration certificate (Packaged: Plastic Box)	8901486160603	
GENMGDC200C	703197	<b>DIAL CALIPER 0-200MM RESOLUTION 0.02MM</b> Hardened stainless steel with deep etched graduations Large, clear dial gauge Resolution: 0.02 mm Accuracy: +/-0.03mm Inside, outside, depth & step measurements Adjustable bezel for zero setting Calibration certificate (Packaged: Plastic Box)	8901486160610	
<b>SLIDE CALIPER</b>				
GEN729ME	703148	<b>SLIDE CALIPER 102MM 4" CAPACITY</b> Caliper with inside and outside readings 1 mm & 16ths Graduations 102mm (4") capacity (Packaged: Carded)	038728425942	
<b>MICROMETERS</b>				
GENMG1001MMC	703187	<b>EXTERNAL MICROMETER 0-25MM</b> Forged steel frame eliminates flexing Reads to 0.01mm. Accurate to 0.004mm Positive spindle lock holds measurement Quick and easy zero adjustment with spanner wrench (included) (Packaged: Plastic Box)	8901486161006	
GENMG1002MMC	703188	<b>EXTERNAL MICROMETER 25-50MM</b> Forged steel frame eliminates flexing Reads to 0.01mm. Accurate to 0.004mm Positive spindle lock holds measurement Quick and easy zero adjustment with spanner wrench (included) Supplied with master (Packaged: Plastic Box)	8901486161013	
<b>SCRIBERS</b>				
GEN80	703159	<b>SCRIBER FIXED 2 POINT 215MM</b> Straight Point and 90° Bent	038728310903	
GEN88CM	703177	<b>SCRIBER TUNGSTEN CARBIDE TIP W/ MAGNET</b> 138mm Screw chuck for reversing point when not in use Pocket clip (Packaged: Carded)	038728311160	
GEN88P	703178	<b>SCRIBER SPARE TIP SUITS GEN88CM</b> Suits GEN88CM	038728311146	
<b>ANGLE-IZER</b>				
GEN836	703171	<b>ANGLE-IZER</b> Ultimate template tool that forms into the shape required Use for bricks, tiles, timber etc Includes Free instructional CD	038728083609	

PART NO.	ITEM	DESCRIPTION	BARCODE	IMAGE
<b>CONTOUR GAUGE</b>				
GEN837	703172	<b>CONTOUR GAUGE 152X89MM</b> Stainless steel pins 152mm X 89mm Ultra thin 35 leaves per inch Overall travel 5-1/4"	038728241160	
<b>COMPASS</b>				
GEN842	703173	<b>PENCIL COMPASS 229MM DIAMETER SPRING LOADED</b> Spring tension adjustment for 229mm diameters (Packaged: Blister)	038728241269	
<b>SCREWDRIVERS</b>				
GEN500	703129	<b>SCREWDRIVER PRECISION SET POWERED WITH 6 X 3MM BITS</b> 100+ RPM with Forward & Reverse action Quick change chuck Includes Six 1/8" (3 mm) precision bits (Packaged: Blister)	038728021328	
GEN1700	703110	<b>SCREWDRIVER SET LIGHTED WITH 3 REV. BLADES</b> Includes Hard Bit Organizer with 3 Reversible Blades Push ON/OFF Powerful LED light Includes 3 X LR44 Batteries (Packaged: Blister)	038728260024	
GEN751016	703151	<b>SCREWDRIVER TECHNICIANS SET WITH 8 DOUBLE ENDED BLADES</b> Eight double-ended screwdriver blades provide viable solutions for most fasteners and are easily stored beneath the handle cap (Packaged: Carded)	038728751065	
GEN80075	703161	<b>SCREWDRIVER OFFSET SET 9 PIECE RATCHET</b> Includes 8 alloy steel bits 1/4" & 3/16" Slotted bits No.1 & No.2 Phillips Bits T15 & T20 Torx 1/8" & 5/32" Hex (Packaged: Carded)	038728800756	
GEN8075X	703165	<b>SCREWDRIVER OFFSET RATCHET WITH SLOT &amp; PHILLIPS</b> With 6mm straight & No 2 cross point blades	038728426673	
GEN86014	703175	<b>14 PIECE SAW DRIVER SET</b> Comfortable handle locks in both straight and pistol-grip positions. Includes: • 3 reciprocating saw blades (drywall, metal and wood). • 7 insert bits • 1/4" socket adapter 4" magnetic bit holder Dual position locking handle Travel holster with belt clip Popular 4-in-1 tool offers a variety of options: Jab Saw - Straight handle position with sheet rock saw blade Keyhole Saw - Pistol grip handle position and reciprocating saw blades Power Driver - Pistol grip handle position with insert bit adapter Speed Driver - Straight handle position with insert bit adapter Swivel locking chuck holds all reciprocating blades and speed shank power bits Removable handle cap with storage for seven insert bits Entire set fits into travel holster	038728860149	



PART NO.	ITEM	DESCRIPTION	BARCODE	IMAGE
<b>PLUMBING</b>				
<b>TUBE CUTTERS</b>				
GEN120	703087	<b>TUBING CUTTER WITH ROLLERS 3-29MM CAPACITY STANDARD</b> Standard - Rollers allow tubing to be cut close to the flared end. Hardened steel reamer slides & locks in place. Replacement cutting wheels available Cutting Capacity: 3mm - 29mm	038728120038	
GEN125	703088	<b>TUBING CUTTER WITH ROLLERS 6-38MM CAPACITY HEAVY DUTY</b> Heavy Duty - Largest capacity cast frame cutter. Twin hardened flare groove rollers Double retractable tool steel reamer Replaceable cutting wheels available Capacity: 6mm - 38mm	038728120151	
<b>FLARING TOOLS</b>				
GEN151	703102	<b>FLARING TOOL 3/16 - 5/8" CAST IRON YOLK</b> Cast iron yolk 3/16", 1/4", 5/16", 3/8", 7/16", 1/2", 5/8"	038728140081	
<b>INSPECTION TOOLS</b>				
<b>MAGNIFYING GLASSES</b>				
GEN800543	703160	<b>MAGNIFYING GLASS LIGHTED LED 90MM DIAMETER 3X</b> 90mm diameter LED Light 3X Magnification with 6X Inset lens 2 - AA Batteries (included) (Packaged: Blister)	038728260017	
GEN700540	703138	<b>MAGNIFYING GLASS 50MM DIAMETER 1.6X</b> Polished optical glass with metal frame. Non slip cushion grip Diameter: 50mm, Power: 1.6X, Focal Length 150mm (Packaged: Carded)	038728005403	
GEN750542	703149	<b>MAGNIFYING GLASS 75MM DIAMETER 1.6X</b> Polished optical glass with metal frame. Non slip cushion grip Diameter: 75mm, Power: 1.6X, Focal Length 150mm (Packaged: Carded)	038728505422	
GEN750544	703150	<b>MAGNIFYING GLASS 100MM DIAMETER 1.6X</b> Polished optical glass with metal frame. Non slip cushion grip Diameter: 100mm, Power: 1.25X, Focal Length 200mm (Packaged: Carded)	038728505446	
<b>MAGNIFYING BINOCULAR</b>				
GEN950-5	703179	<b>MAGNIFIER BINOCULAR 2.25X</b> Leaves hands free to work Ground & polished optical lenses Eliminate eye strain Magnification: 2.25 Focal Length: 200mm	038728437341	
<b>REVOLVING PUNCH</b>				
GEN72	800481	<b>REVOLVING PUNCH PLIER 2MM-4.5MM</b> The Revolving Punch Pliers are ideal for making minuscule punch holes that would not be practical with a single-style punch. The revolving turret offers six distinct punch sizes for use on leather, rubber, plastic and similar materials. Features & Benefits A convenient spring tension, self-opening tool for punching round holes in leather, plastic, rubber, canvas, cardboard and similar materials Made of plated steel with six tapered and hollow, hardened steel punches Punch sizes: 5/64", 3/32", 7/64", 1/8", 5/32", 3/16" (2.0, 2.5, 3.0, 3.5, 4.0, 4.5)	681035015841	

PART NO.	ITEM	DESCRIPTION	BARCODE	IMAGE
<b>INSPECTION MIRRORS</b>				
GEN709555	703144	<b>INSPECTION MIRROR 38MM</b> Overall length: 203mm Mirror Diameter: 38mm	038728709554	
GEN759570	703153	<b>INSPECTION MIRROR TELESCOPING</b> Rectangular mirror that resists scratching & shattering High strength corrosion resistant stainless steel wand telescopes from 9-1/4" to 30" (235 mm-762 mm)	038728759504	
GEN80560	703162	<b>INSPECTION MIRROR TELESCOPING, LIGHTED</b> Fully polished 2" x 3" (50 mm x 75 mm) glass mirror is shatter-resistant 360° Swivel double ball joint 2 Extra bright LED lights Telescoping Shaft: 8 to 33 in. (205 to 840mm) (Packaged: Blister)	038728021465	
GEN557	703133	<b>INSPECTION MIRROR 56MM TELESCOPING</b> 262mm Length extends to 375mm	038728424686	
<b>AIRFLOW METER</b>				
GENDAF3010B	703180	<b>AIR FLOW METER, DIGITAL DISPLAY</b> Measure & monitor airflow efficiency in A/C & ventilation systems & for outdoor use Measures current, average, or maximum wind speed Wind chill indication LCD display with backlit for easy reading Selectable air speed units of Ft/min, m/s, km/hr, MPH & Knots Selectable °C / °F Battery status indication (Battery included 1 x CR2032) (Packaged: Blister)	681035014042	
<b>MOISTURE METER</b>				
GENMMD4E	703198	<b>MOISTURE METER, DIGITAL DISPLAY</b> Accurately measure moisture content in wood, concrete, drywall, subflooring etc Strong stainless steel pins LCD moisture level indicator Audible alarms with 8 different tone levels Range: Wood 5% - 50%, Building Material 1.5% - 33% Resolution: 0.1%, Accuracy +/- 3% Built-in low battery indication Hold button to freeze/hold reading (Packaged: Blister)	681035414477	
<b>INFRARED THERMOMETER</b>				
GENIRT207	703186	<b>INFRARED THERMOMETER, DIGITAL DISPLAY</b> Rugged and ergonomic design Backlit LCD display Switchable On/Off Laser sighting Selectable °C / °F Auto off CE, RoHS, WEEE approved Distance to Spot (DS) ratio: 8:1 Range: -4° to 604°F (-20° to 317°C) Emissivity: Fixed at 0.95 Resolution: 0.5°F / 0.5°C Accuracy: ±2% Operating temperature: 0°C to 50°C Power Source: 1 X 9V battery (included) (Packaged: Blister)	681035014035	



PART NO.	ITEM	DESCRIPTION	BARCODE	IMAGE
<b>DIGITAL MULTIMETER</b>				
GENMMM830HS	800482	<b>DIGITAL MULTIMETER WITH LED AND CONTINUITY BEEPER</b> Measures AC/DC voltage, DC current resistance, continuity, diode integrity, transistor (current gain) 20 ranges 3-1/2-digit LCD Red LED identifies hot side lead Continuity Beeper with Red Lead Ground disconnect check circuit Specifications : AC Voltage: 220V , 750V (2 Ranges) DC Voltage: 2V to 1000V (4 Ranges) DC Current: 200uA to 10A (5 Ranges) Resistance: 200Ω to 2MΩ (5 Ranges) Power Source: 1 "9V" battery (included) Test leads Transistor hFE: NPN, PNP (2 Ranges) Diode Test	681035501009	
<b>COMBUSTIBLE GAS DETECTOR</b>				
GENPNG2000A	703201	<b>COMBUSTIBLE GAS DETECTOR PEN</b> Check gas leaks in plumbing & appliances Easy to operate High Sensitivity Audible & visual alarms Response time: < 5s Alarm level: >65dB Includes 2 x AA Batteries & Wrist Strap (Packaged: Blister)	681035415016	
<b>THERMO-HYGROMETER</b>				
GENPTH8707	703202	<b>THERMO-HYGROMETER PEN DIGITAL DISPLAY</b> Measure temperature & humidity °C / °F selectable Min / Max feature Pocket clip Humidity Range: 20% to 100% RH Temperature Range: 0°C to 50°C (Packaged: Blister)	681035014028	
<b>VIDEO BORESCOPIES</b>				
GENDCS300	703182	<b>VIDEO BORESCOPE 3.5" SCREEN 12MM DIA CAMERA</b> (89 mm) screen 12 mm diameter camera-tipped flexible probe Built-in adjustable LED lighting Flexible water, oil, & dust resistant (IP67) probe Colour LCD screen Includes Case, 1 mtr probe, Extension tools: Mirror, Magnet, Pick Up, Hook Battery Included (9V) (Packaged: Display Box)	681035013731	
GENDCS400	703183	<b>WIRELESS VIDEO BORESCOPE 3.5" SCREEN 12MM DIA CAMERA</b> 3.5" (89 mm) colour LCD screen can be detached for remote viewing up to 10M away 12 mm diameter camera-tipped flexible probe Built-in adjustable LED lighting Flexible water, oil, & dust resistant (IP67) probe View live & records still photos (JPEG) & video (AVI) up to 3 hours PAL or NTSC compatible 3 Menu languages: English, French, Spanish Includes Case, 1 mtr probe, 2GB Mirco SD Memory Card, USB Cable, A/V out cable, Rechargeable battery & AC charger, Twin charging cable, Extension tools: Mirror, Magnet, Pick Up Hook (Packaged: Display Box)	681035013717	
<b>SPECIALTY TOOLS</b>				
<b>KNIFE SET</b>				
GEN75622	703152	<b>KNIFE SET 22 PIECE PRECISION BLADES</b> Includes 2 Multi blade handles 22 blades (8 varied shapes)	038728756220	

**GENERAL**





PART NO.	ITEM	DESCRIPTION	BARCODE	IMAGE
<b>PICK-UPS</b>				
GEN759582	703154	<b>PICKUP TOOL LIGHTED MAGNETIC TELESCOPIC</b> Telescoping wand extends from 7-3/4" (197 mm) to 28-3/4" (730 mm) Double ball joint neck allows limitless angle adjustments Includes 4 Alkaline LR41 batteries (Packaged: Blister)	038728759672	
GEN70396	703139	<b>PICKUP TOOL LIGHTED MECHANICAL</b> Illuminated Mechanical Pick Up 508mm Flexible shaft Strong retrieval claw for objects up to 25mm (Packaged: Blister)	038728260031	
<b>TWEEZERS</b>				
GEN70401	703140	<b>LIGHTED TWEEZER 159MM SMOOTH POINTED</b> 3 LR41 Batteries (Packaged: Blister)	038728260048	
GEN70403	703141	<b>LIGHTED TWEEZER 159MM SERRATED BLUNT</b> 3 LR41 Batteries (Packaged: Blister)	038728260055	
GEN70408	703142	<b>LIGHTED TWEEZER 159MM SERRATED BENT</b> 3 LR41 Batteries (Packaged: Blister)	038728260062	
<b>FILES</b>				
GEN707476	703143	<b>NEEDLE FILE SET 6 FILES WITH HOLDER</b> Set includes 6 different files Triangular, Mill, Round, Square, Warding, Half Round	038728707468	
<b>ENGRAVER</b>				
GEN505	800483	<b>CORDLESS ENGRAVER DIAMOND TIP BIT - CARDED</b> This new and exciting tool enables precision cordless engraving anywhere by anyone from professional technicians and mechanics to homeowners and DIYers. Users can protect all types of valuables with identifying markings and even perform delicate personalization of items. Designed in-house by General's engineering team (Patent Pending), the engravers powerful 20,000 RPM motor is powered by just two AAA batteries and enables engraving in glass, metal, ceramic and plastic. An aluminium body offers superior durability and the one-of-a-kind tri-lobe ergonomic grip provides the ultimate in comfort and ease-of-use. Features & Benefits Diamond Tip Bit; Precision cordless engraving anywhere; Use on metal, plastic, ceramic or glass surfaces; Protects all types of valuables; Uses standard 3/32" engraving bit; Aluminium body 20,000 RPM motor; 2 AAA batteries (included)	038728021397	
<b>PROBE SET</b>				
GEN60004	703137	<b>PROBE SET 4 PCE STRAIGHT, HOOK, 2X BEND</b> Straight, 180° Hook, 35° Bend, 90° Bend (Packaged: Carded)	038728600042	

# PAULCALL

Australian manufactured range of quality spring clamps, G-Clamps, Gluing Clamp and Brass Drift Punches.

Paulcall Spring Clamps are regarded by Industrial and Trade users as having the strongest spring tension of any spring clamp available in our market and therefore superior to most imported products.



PART NO.	ITEM	DESCRIPTION	BARCODE	IMAGE		
<b>CLAMPS</b>						
<b>G CLAMPS</b>						
Malleable, rustproof, virtually unbreakable						
		Malleable	Opening	Throat		
JFP04	503505	G CLAMP #P04 1 1/4"	1 1/4" (32mm)	3/4" (19mm)	9314697000030	
JFP05	503506	G CLAMP #P05 2"	2" (52mm)	1" (26mm)	9314697000047	
JFP03	503504	G CLAMP #P03 3"	3" (75mm)	2" (52mm)	9314697000023	
JFP08	503507	G CLAMP #P08 4"	4" (100mm)	2 1/2" (63mm)	9314697000054	
JFP014	503502	Deep Throat Clamp 3" X 4 1/2"	3" (75mm)	4 1/2" (115mm)	9314697000078	
<b>GLUING CLAMP</b>						
JFP010	503497	GLUING CLAMP #P010 Used with 3/4" threaded water pipe of any length.	9314697000085			
<b>SPRING CLAMPS</b>						
Rustproof extra strong springs						
Part No.		Description	Opening	Length		
JF27/1	503472	SPRING CLAMP 25MM/1"	1" (26mm)	4" (100mm)	9314697000092	
JF27/2	503473	SPRING CLAMP 50MM/2"	2" (52mm)	6" (150mm)	9314697000008	
JF27/3	503474	SPRING CLAMP 75MM/3"	3" (76mm)	9" (230mm)	9314697000115	
<b>BRASS DRIFTS</b>						
Brass drifts are designed to be used where a softer material is required to avoid damage to machine parts. The object being struck is typically a hardened steel bearing, pin or insert.						
JFBD152/9.5	503479	BRASS DRIFT 6X3/8(152X9.5MM)				
JFBD152/13	503476	BRASS DRIFT 6X1/2(152X13MM)				
JFBD152/19	503477	BRASS DRIFT 6X3/4(152X19MM)				
JFBD152/25	503478	BRASS DRIFT 6X1(152X25MM)				
JFBD203/25	503480	BRASS DRIFT 8X1(203X25MM)				
JFBD292/19	503481	BRASS DRIFT 11.1/2X3/4(292X19MM)				
JFBD292/25	503482	BRASS DRIFT 11.1/2X1(292X25MM)				



# **MARSHALLTOWN**

## *The Premier Line*

MARSHALLTOWN manufacturers of premium quality concrete, masonry, asphalt, drywall, plaster, paint, EIFS, flooring and tiling tools and equipment.

QLT by MARSHALLTOWN is a new line that encompasses a wide assortment of dependable tools for the homeowner up to a higher grade tool at a competitive price that will suit the needs of any serious DIYer to general contractor.

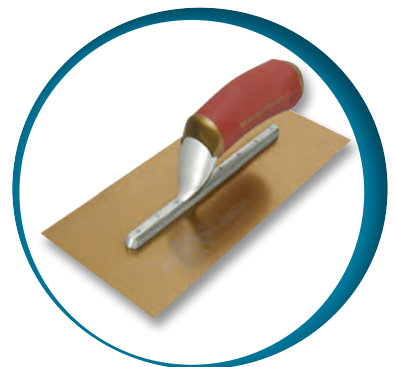

**BARS**

**Monster Pry Bar**

- All steel construction ensures long life
- Powder coated finish
- 56" (1422mm) length gives enough leverage for even the toughest jobs
- Ideal for prying forms and other embedded objects
- 1 per inner/1 per outer pack



**MARSHALLTOWN The Premier Line**

Item	Part No.	Size-in.	Size-mm
506431	MT16595	56	1422

**BOARD / PANEL LIFTER**

**Panel Lifter**

- Non-slip checkered surface provides foot traction
- Self-righting feature makes it ready for use without fumbling
- Tapered front end slides easily under the board; then it lifts and holds it in place while nailing
- Sold 2 per inner pack/2 per outer pack



**MARSHALLTOWN The Premier Line**

Item	Part No.	Size-in.	Size-mm
506511	MT790	12 X 5¼	305 X 133

**BRICK - RUBBING**

**Rub Bricks**

- Available in many sizes with or without handle
- Ideal for dressing down and removing form marks from concrete or cleaning brick
- Sold 1 per inner pack/4 per outer pack, 5 per outer pack where noted with \*

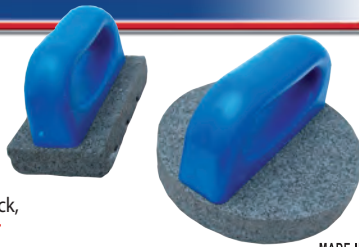

**MARSHALLTOWN The Premier Line**

Item	Part No.	Grit/Description	Size-in.	Size-mm
506430	MT16533	20 Round w/Handle	6 X 1	152 X 25
506517	MT841*	20 Fluted w/Handle	8 X 3½ X 1½	203 X 89 X 38

**BRUSH**

**Masonry Brush**

- Bristles made of white Tampico fiber
- 3½" (89mm) bristles are set securely in hardwood block
- Sold 1 per inner pack/12 per outer pack



**MARSHALLTOWN The Premier Line**

Item	Part No.	Size-in.	Size-mm
506515	MT829	6½ X 1¾	165 X 44

**EDGER**

**Bronze Hand Edgers**

- Made from high quality, long wearing bronze
- Comfortable soft grip with finger guard
- Finely finished to make smooth clean edges
- Sold 1 per inner pack/12 per outer pack



**QLT by MARSHALLTOWN**

Item	Part No.	Size-in.	Size-mm	Radius	Lip
506508	MT7588	6 X 2¾	152 X 70	¼" (6mm)	⅝" (16mm)

**Chamfer Stainless Steel Hand Edgers**

- Blade is made of heavy gauge stainless steel
- Resilient DuraSoft® handle provides a soft feel, reduces fatigue and offers excellent durability
- Used to produce a bevel at the edge of a concrete slab to help prevent the edge from chipping
- Sold 1 per inner pack/6 per outer pack



**MARSHALLTOWN The Premier Line**

Item	Part No.	Size-in.	Size-mm	Lip
506480	MT483CH	6 X 6	152 X 152	¾" (19mm)



## Curved End Hand Edgers

*Stainless Steel*

- Made of, stainless steel with a sturdy mounting welded to the blade
- Both ends are curved up for use in either direction
- Resilient DuraSoft® handle provides a soft feel, reduces fatigue and offers excellent durability
- Used to produce a radius at the edge of a concrete slab to help prevent the edge from chipping
- Curved ends help prevent edger from digging into wet concrete
- Sold 6 per inner pack/6 per outer pack



136SSD

MADE IN U.S.A.

### MARSHALLTOWN The Premier Line

#### Stainless Steel

Item	Part No.	Size-in.	Size-mm	Radius	Lip
506411	MT136SSD	6 X 3	152 X 76	3/8" (10mm)	1/2" (13mm)
506427	MT155SSD	6 X 4	152 X 102	1/4" (6mm)	3/8" (10mm)
506428	MT156SSD	6 X 4	152 X 102	3/8" (10mm)	1/2" (13mm)

## Straight End Hand Edgers

*Stainless Steel*

- Made of, stainless steel with a sturdy mounting welded to the blade
- Resilient DuraSoft® handle provides a soft feel, reduces fatigue and offers excellent durability
- Used to produce a radius at the edge of a concrete slab to help prevent the edge from chipping
- Sold 6 per inner pack/6 per outer pack



MADE IN U.S.A.

### MARSHALLTOWN The Premier Line

#### Stainless Steel

Item	Part No.	Size-in.	Size-mm	Radius	Lip
506429	MT164SSD	6 X 4 1/4	152 X 108	1/4" (6mm)	3/8" (10mm)
506432	MT165SSD	6 X 4 1/2	152 X 115	3/8" (10mm)	1/2" (13mm)
506433	MT166SSD	6 X 4 3/8	152 X 110	1/2" (13mm)	5/8" (16mm)

## EDGER GROOVER, Safety Step

### Stainless Steel Safety Step Edger/Groover

- **4280D** is used to cut four grooves, 3/4" (19mm) apart and 1/4" (6mm) deep and an edge radius of 1/2" (13mm)
- Creates a safety tread effect on steps
- Forms a 1/2" (13mm) radius and a 1/4" (6mm) groove in one pass
- Sold 6 per inner pack/6 per outer pack



MADE IN U.S.A.

### MARSHALLTOWN The Premier Line

Item	Part No.	Size-in.	Size-mm	Radius	Lip
506469	MT4280D	6 X 5	152 X 127	1/2" (13mm)	5/8" (16mm)

## FLOAT

### Beveled End Magnesium Hand Floats

- Extruded from very hard, durable, lightweight magnesium
- Our most popular float design
- Comfortable handle is positioned to give the tool perfect balance
- Recommended for use with air entrained concrete
- Magnesium floats produce a smoother finish than wood
- Sold 6 per inner pack/6 per outer pack



MADE IN U.S.A.

### MARSHALLTOWN The Premier Line

Item	Part No.	Size-in.	Size-mm	Handle
506421	MT142D	12 X 3 3/8	305 X 79	
506424	MT145D	16 X 3 3/8	406 X 79	
506426	MT146D	20 X 3 3/8	508 X 79	

### Round End Magnesium Hand Floats

- Extruded from very hard, durable, lightweight magnesium
- Fully rounded ends help prevent float marks
- Comfortable handle is positioned to give the tool perfect balance
- Magnesium floats produce a smoother finish than wood
- Handles are secured with torque pad screws that will not back out
- Sold 6 per inner pack/6 per outer pack



MADE IN U.S.A.

### MARSHALLTOWN The Premier Line

Item	Part No.	Size-in.	Size-mm	Handle
506422	MT143D	16 X 3 3/8	406 X 79	

## "The Hog" Magnesium Hand Floats

- Extruded from very hard, durable, lightweight magnesium
- Wide blade covers more surface area and wears longer
- Handle is secured with torque pad screws that will not back out
- Recommended for use with air entrained concrete
- Comfortable handle is positioned to give the tool perfect balance
- Sold 6 per inner pack/6 per outer pack



MADE IN U.S.A.

### MARSHALLTOWN The Premier Line

Item	Part No.	Size-in.	Size-mm	Handle
506504	MT738D	16 X 3 3/4	406 X 95	

## Sponge Float

- Fine cell yellow foam pad specially bonded to an aluminium backing plate
- Wears well and does an excellent job on any sand surface
- Pad is 1 1/8" (28mm) thick
- Sold 1 per inner pack/12 per outer pack
- Replacement pads are packed 6 per bag, 1 per inner pack/12 per outer pack



ASSEMBLED IN U.S.A.

### MARSHALLTOWN The Premier Line

Item	Part No.	Description	Size-in.	Size-mm
506472	MT4412	Float	11 X 5 1/2	279 X 140
506473	MT4419	Replacement Pad	11 X 5 1/2	279 X 140

## Tile Grouter's Floats

- Pure gum rubber face is bonded to the dense rubber pad; cemented to an aluminium backing plate with a smooth handle
- Edges are beveled and the two front corners are rounded
- Dense rubber pad is designed specifically for tile grouting
- **43BC** has an offset handle for base/cove work



ASSEMBLED IN U.S.A.

### MARSHALLTOWN The Premier Line

Item	Part No.	Size-in.	Size-mm
506470	MT43	9 X 4	229 X 102
506471	MT43BC	12 X 3	305 X 76

## Tile Grouter's Float

- Pure gum rubber face is bonded to the dense rubber pad; tempered steel blade with a soft grip handle
- Edges are beveled
- Specifically for tile grouting
- Sold 1 per inner pack/6 per outer pack



### QLT<sup>TM</sup> MARSHALLTOWN

Item	Part No.	Size-in.	Size-mm
511046	MTGF248	9 X 4	229 X 102

## Float Handles

- Fit all of our magnesium hand floats
- Sold 12 per inner pack/12 per outer pack



MADE IN U.S.A.

### MARSHALLTOWN The Premier Line

Item	Part No.	Description	Size-in.	Size-mm
511028	MT16D	DuraSoft <sup>®</sup>	9 X 1 1/4	229 X 31

## GROOVER

## Bronze Hand Groovers

- Made from high quality, long wearing bronze
- Comfortable soft grip
- Finely finished to make smooth clean grooves
- Sold 1 per inner pack/12 per outer pack



### QLT<sup>TM</sup> MARSHALLTOWN

Item	Part No.	Size-in.	Size-mm	Radius	Width	Depth
506503 <sup>^</sup>	MT7374	8 X 4 1/2	203 X 152	1/4" (6mm)	1/2" (13mm)	1" (25mm)

## Stainless Steel Rocker Groover

*Stainless Steel!*

- Groover blade has a slight bow which gives this tool a "rocker" effect
- Made of heavy gauge stainless steel and strengthened by a stiffening strip
- Powder coat finish
- Sold 6 per inner pack/6 per outer pack
- Available in inner pack quantities only



MADE IN U.S.A.

### MARSHALLTOWN The Premier Line

Item	Part No.	Size-in.	Size-mm	Radius	Depth
506438	MT1790D	6 X 3 1/2	150 X 90	1/4" (6mm)	1/2" (13mm)



## HANDLE

### Push Button Handle Sections

- Constructed of thick-walled aluminium tubing
- Heat-treated, lightweight
- Quick connect snap spring positively locks handles in place
- **WARNING:** When using handle extensions, always avoid contact with electrical power lines or any electrical source
- Sold 6 per inner pack/6 per outer pack
- Available in inner pack quantities only



**DLT** by MARSHALLTOWN

Item	Part No.	Description	Size in.	Size mm	Diameter
506436	MT17-6ASU	Powder Coated - Blue	72	1829	1 3/8" (35mm)

## HAWK

### Aluminium Hawks

- Made of heavy gauge hard-rolled aluminium
- Edges have been smoothed and the corners rounded
- Has a threaded 3 5/8" (92mm) flange
- Handle and sponge rubber callus preventer included
- "D" indicates DuraSoft® handle
- Sold 1 per inner pack/12 per outer pack

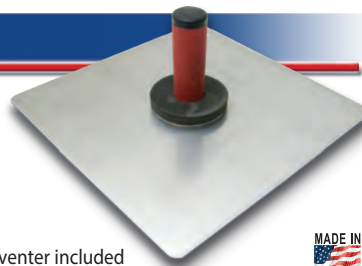

MADE IN U.S.A.

**MARSHALLTOWN** The Premier Line

Item	Part No.	Size-in.	Size-mm	Handle
506495	MT5D	12 X 12	305 X 305	
506445	MT1D	13 X 13	330 X 330	
506501	MT6D	14 X 14	356 X 356	

### Magnesium Hawks

- Made of lightweight durable magnesium
- Score marks are machined to a uniform depth and specially shaped to help the blade remain flat
- Has a threaded 3 5/8" (92mm) flange
- Sponge rubber callus preventer and handle included
- Used for holding plaster during application
- "D" indicates DuraSoft® handle
- Sold 1 per inner pack/12 per outer pack, sold 1 per inner pack/18 per outer pack where noted with \*

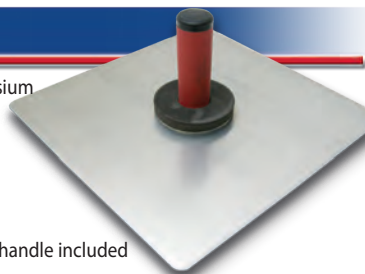

MADE IN U.S.A.

**MARSHALLTOWN** The Premier Line

Item	Part No.	Size-in.	Size-mm	Handle
506486	MT5206D	13 X 13	330 X 330	
506487	MT5208D	14 X 14	356 X 356	

## HOE

### Mortar Hoe

- Steel ferrule riveted to one piece forged carbon steel head
- **14281** has a heavy duty 18" (457mm) hardwood handle with sturdy "D" grip
- Sold 1 per inner pack/4 per outer pack



**MARSHALLTOWN** The Premier Line

Item	Part No.	Description	Blade-in.	Blade-mm
506419	MT14281	D-Grip	4 3/4 X 7	121 X 178

## HOPPER GUN

### SharpShooter® I Hopper Gun

- Specially formulated nylon gun
- Seven orifice sizes with tubular design for reduced overspray and greater texture variety
- Knurled knobs let you adjust the orifice plate without wrenches
- Tight sealing flow shutoff prevents leakage
- Angled hopper adapter allows hopper to remain level while spraying floors and ceilings
- Gun features a handy air control valve which allows flow control at the gun instead of at the pump
- Easy pull swing trigger for greater control and less fatigue
- Adjustable trigger stop for consistency of pattern
- Hopper with seamless corner design eliminates material build-up and reduces clogging
- Plastic hopper capacity is approximately (7.57 litres)
- Sold 1 per inner pack/1 per outer pack



45° Angle Adapter Included

New Hopper Design!

MADE IN U.S.A.

**MARSHALLTOWN** The Premier Line

Item	Part No.	Description	Size-in.	Size-mm
506500	MT693	Hopper Gun	N/A	N/A

**JOINTER**
**Brick Jointers**

- Made from high carbon steel
- Each end is a different joint size
- 10½" (267mm) length
- Sold 6 per inner pack/72 per outer pack



**MARSHALLTOWN The Premier Line**

Item	Part No.	Size-in.	Size-mm
506512	MT80	½ & ⅝	13 & 16
506513	MT81	¾ & ⅞	19 & 22
506514	MT82	⅝ & ¾	16 & 19
506516	MT83	⅜ & ½	10 & 13

**Barrel Jointer**

- Barrel jointer set includes four popular sizes of changeable hardened steel barrels - ½", ⅝", ¾" and ⅞" (13mm, 16 mm, 19mm, and 22mm)
- Threaded barrels are easy to change
- Sold 6 per inner pack/60 per outer pack, replacement barrels are sold 6 per inner pack/6 per outer pack





**QLT<sup>®</sup> MARSHALLTOWN**

Item	Part No.	Description	Size-in.	Size-mm
506525	MTBJ850	Barrel Jointer	8½ X 2½	216 X 64
506608	MTRB852	Repl. Barrels	⅝"	16
506610	MTRB854	Repl. Barrels	⅞"	22

**KNIFE - JOINTING**
**Soft Grip Putty and Joint Knives**

- Blade is high carbon steel
- Soft grip handle
- Sold 6 per inner pack/72 per outer pack

**QLT<sup>®</sup> MARSHALLTOWN**

Item	Part No.	Description	Size-in.	Size-mm
506542	MTFJK4HH	Flex Joint Knife 	4	102
506543	MTFJK5HH	Flex Joint Knife 	5	127
506544	MTFJK6HH	Flex Joint Knife 	6	152

**Nylon Handle Putty and Joint Knives**

- Heat treated, hardened and tempered; annealed for an even hardness throughout the blade
- Full tang through the handle
- Smooth black polyethylene handle resistant to virtually all chemicals and solvents
- Weighted handle accommodates our heavier blades for perfect balance
- Sold 6 per inner pack/24 per outer pack,

**M5763**
**MARSHALLTOWN The Premier Line**

Item	Part No.	Description	Size-in.	Size-mm
506567	MTM5753	Flex Joint Knife 	5	127
506568	MTM5763	Flex Joint Knife 	6	152

 symbol designates our EMPACT hammering head handle

## DuraSoft® Handle Putty and Joint Knives

- Next generation ergonomic design offers the most comfortable grip possible
- Solid handle construction ensures the strongest and longest lasting tool available
- Oversized EMPACT hammering head for quick, effective hammering
- Patent Pending handle design
- All 3" scraper blades have a 5° angle
- Sold 6 per inner pack/6 per outer pack,



U.S. Patent Nos.  
D535,541,  
D527,244  
D526,881, &  
D525,510

### MARSHALLTOWN The Premier Line

Item	Part No.	Description	Size-in.	Size-mm	Handle
506602	MTPK877D	Flex Putty Knife	1½	38	D
506603	MTPK878D	Flex Putty Knife	2	51	C
506553	MTJK884D	Flex Joint Knife	5	127	D
506555	MTJK886D	Flex Joint Knife	6	152	D
506616	MTSK880D	Flex Scraper	3	76	D
506618	MTSK882D	Flex Scraper	4	102	D

symbol designates our EMPACT hammering head handle

## Nylon Handle Putty and Joint Knives

- Heat treated, hardened and tempered; annealed for an even hardness throughout the blade
- Full tang through the handle
- Smooth black polyethylene handle resistant to virtually all chemicals and solvents
- Weighted handle accommodates our heavier blades for perfect balance
- All 3" scraper blades have a 5° angle
- Sold 6 per inner pack/24 per outer pack



### MARSHALLTOWN The Premier Line

Item	Part No.	Description	Size-in.	Size-mm
506558	MTM5123	Flex Putty Knife	1¼	31
506561	MTM5303	Flex Scraper	3	76
506566	MTM5743	Flex Scraper	4	102

symbol designates our EMPACT hammering head handle

## KNIFE - TAPING

### DuraSoft® Stainless Steel Taping Knives

- Tempered premium stainless steel blade with aluminium backing plate
- Tapered blade flexes just right for feathering but won't take a set
- Resilient DuraSoft® handle provides a soft feel, reduces fatigue and offers excellent durability
- Sold 6 per inner pack/6 per outer pack



### MARSHALLTOWN The Premier Line

Item	Part No.	Size-in.	Size-mm
506458	MT3508SD	8 X 3	203 X 76

### Soft Grip Blue Steel Taping Knives

- Flexible blue spring steel blade
- Tapered blade lets you get close to the corner
- One of the most lightweight taping knives on the market
- Comfortable soft grip handle is securely molded to an aluminium backing plate
- Sold 6 per inner pack/6 per outer pack



### QLT BY MARSHALLTOWN

Item	Part No.	Size-in.	Size-mm
506527	MTBSTK8	8 X 3	203 X 76
506526	MTBSTK12	12 X 3	305 X 76

## LEVEL

### Line Level

- Break resistant reversed line hooks for positive hold
- Lightweight design eliminates line sag
- Sold 10 per inner pack/100 per outer pack

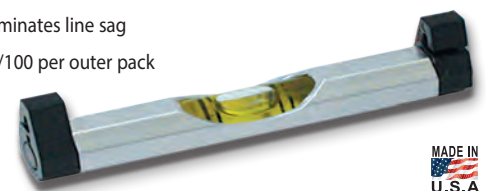

### MARSHALLTOWN The Premier Line

Item	Part No.	Size-in.	Size-mm
511029	MT16554	N/A	N/A

## PLACER

### All Aluminium Placers

- Aluminium construction, powder coated with soft grip end-cap
- Braced for additional strength
- 60" (1524mm) long
- AP753H has a hook
- Sold 5 per inner pack/5 per outer pack
- Available in inner pack quantities only

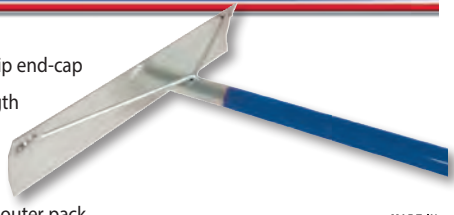

#### MARSHALLTOWN The Premier Line

Item	Part No.	Description	Blade Size-in.	Blade Size-mm
506522	MTAP753F	Placer w/o Hook	19½ X 4	495 X 102
511030^	MTAP753H	Placer w/ Hook	19½ X 4	495 X 102

## All Aluminium Open Angle Pull Crete

- Lightweight aluminium construction
- Braced for additional strength
- Durable powder coated handle and rubberized grip
- Handle measures 60 X 1 3/8" (1524 X 35mm)
- Sold 5 per inner pack/5 per outer pack

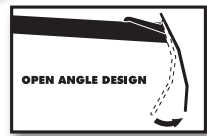

#### MARSHALLTOWN The Premier Line

Item	Part No.	Description	Blade Size-in.	Blade Size-mm
511045^	MTRED700158	Placer w/o Hook	20 X 3¾	508 X 95

## RAKER

### Joint Raker

- Large 1 3/4" (44mm) skate wheels
- Strong aluminium handle is contoured to fit the hand and squared off at the end
- Hardened nail, adjusts to proper depth
- Sold 12 per inner pack/12 per outer pack



#### MARSHALLTOWN The Premier Line

Item	Part No.	Size-in.	Size-mm
506519	MT89	8½ X 3	216 X 76

## REEL, Tie Wire

### Tie Wire Reels

- Constructed of lightweight aluminium
- Fits any standard size belt
- Accommodates all types of tie wire
- Sold 1 per inner pack/6 per outer pack



#### QLT by MARSHALLTOWN

Item	Part No.	Description
506630	MTTWR19	Aluminium

## SPONGE

### Tile Grout and Grout Scrubbing Sponges

- Used to wipe off excess grout from joints
- Rounded corners to prevent digging out or marring joints
- Inner/outer pack quantities shown in table, individually bagged sponges are noted in table with \*



#### MARSHALLTOWN The Premier Line

Item	Part No.	Description	Size-in.	Size-mm	Qty.
506627	MTTGSL	Large*	6½ x 4¼ x 2½	165 x 108 x 54	50/50
506626	MTTGS1	XL*	7¼ x 5½ x 2¼	184 x 130 x 57	40/40

- For scrubbing and haze removal
- Yellow grout sponge on one side to wipe off excess grout from joints
- White scrubber side to remove grout haze and stubborn mortar colors
- Sold 50 per inner pack/50 per outer pack



#### MARSHALLTOWN The Premier Line

Item	Part No.	Size-in.	Size-mm
506628	MTTLW	6½ X 4¼ X 2½	165 X 108 X 54

## TOOLBAG

### Medium Nylon Tool Bag

- Made of a double layer of durable, water-resistant nylon with a reinforced bottom panel
- Padded handles and an adjustable shoulder strap
- Has 6 multi-purpose inside pockets, 6 outside pockets and 6 outside web pockets
- Sold 1 per inner pack/6 per outer pack



#### MARSHALLTOWN The Premier Line

Item	Part No.	Size-in.	Size-mm
506596	MTNB202	20L X 8½W X 13½H	508L X 216W X 343H

MARSHALLTOWN The Premier Line

# MARSHALLTOWN®

## BRICK TROWELS

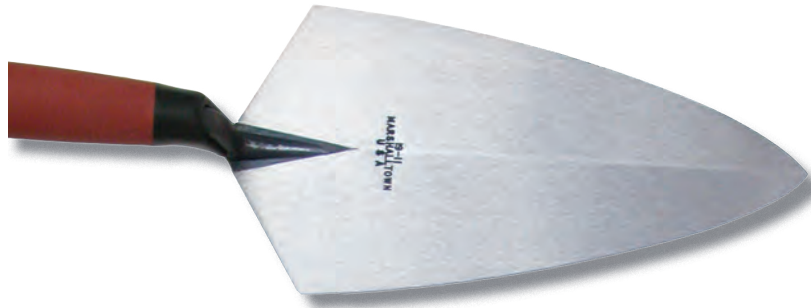

### PHILADELPHIA PATTERN

Philadelphia pattern trowels are better suited for laying block because they allow for more mortar to be placed on the blade



### LONDON PATTERN

London pattern trowels are the standard blade type for laying brick.



### WIDE LONDON PATTERN

Wide London pattern trowels can be used for laying brick or block. The rounded heel places the mortar further forward on the blade than the Philadelphia style trowels.

### When you purchase a MARSHALLTOWN® Brick Trowel There Are No Surprises

No other brick trowel manufacturer can match MARSHALLTOWN's commitment to providing consistent quality. It all starts with our steel; a proprietary formula developed for the unique requirements of a brick trowel. We take our steel and carefully forge and heat treat it into brick trowels by using state of the art equipment that we have developed and refined into a unique factory dedicated to making the best brick trowels in the world. Our handle rise is always set at precisely the same angle. We hold extremely tight tolerances on blade thickness to maintain consistent flexibility and strength on every trowel we sell. We precisely maintain blade chemistry and hardness to guarantee that your trowel will perform better than expected. This all means that every single MARSHALLTOWN brick trowel we make is great. Most manufacturers can make a few good brick trowels, and maybe even one or two great ones. But they also make bad trowels, and you have to suffer through those bad trowels to get the few good ones. Choosing a MARSHALLTOWN brick trowel means that you choose to get a great brick trowel every time, so there are no surprises.

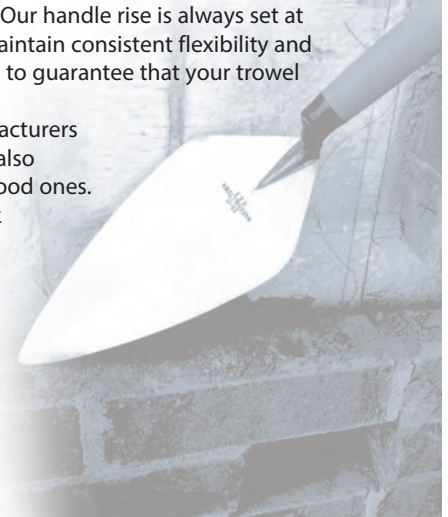

**TROWELS**
**BRICKIES**
**Philadelphia Style**

- Forged from a single piece of high carbon steel, then heat treated for strength and durability
- Blade is taper ground and polished
- Handle rise is set for the correct hang and balance
- Impact area is extra strong
- Supplied with plastic retail hangers

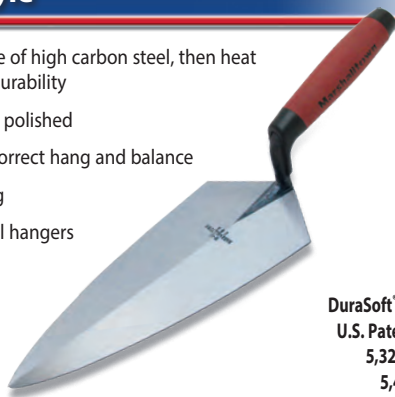

DuraSoft® Handle  
U.S. Patent Nos.  
5,327,612 &  
5,446,941

**MARSHALLTOWN The Premier Line**

Item	Part No.	Size-In.	Size-mm	Handle
506442	MT19/12FGXH	12 X 6	305 X 152	
506444	MT19P12XH	12 X 6	305 X 152	

**Philadelphia Style**

- Durable construction
- Perfect for projects of any size
- Designed for repeated use but priced for the Do-It-Yourselfer
- Soft Grip handle for increased comfort
- Sold 1 per inner pack/12 per outer pack

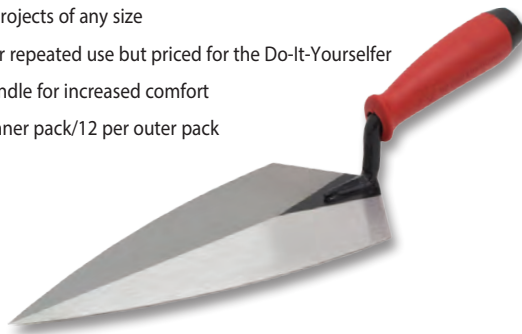

**QLT** by MARSHALLTOWN

Item	Part No.	Size-In.	Size-mm
510804	MT19087	12 X 6	305 X 152

**London Style**

- Forged from a single piece of high carbon steel, then heat treated for strength and durability
- Handle rise is set for the correct hang and balance
- Blade is taper ground and polished
- Impact area is stronger
- Supplied with plastic retail hangers



DuraSoft® Handle  
U.S. Patent Nos.  
5,327,612 &  
5,446,941

**MARSHALLTOWN The Premier Line**

Item	Part No.	Size-in.	Size-mm	Handle
506448	MT33/13FGXH	13 X 5 7/8	330 X 137	

**Wide London Style**

- Forged from a single piece of high carbon steel, then heat treated for strength and durability
- Blade is taper ground and polished
- Impact area is extra strong
- Handle rise is set for the correct hang and balance
- Supplied with plastic retail hangers



DuraSoft® Handle  
U.S. Patent Nos.  
5,327,612 &  
5,446,941

**MARSHALLTOWN The Premier Line**

Item	Part No.	Size-in.	Size-mm	Handle
506451	MT34/12FGXH	12 X 5 3/4	305 X 146	
506456	MT34P12XH	12 X 5 3/4	305 X 146	

**Wide London Style**

- Durable construction
- Perfect for projects of any size
- Designed for repeated use but priced for the Do-It-Yourselfer
- Soft grip handle for increased comfort
- Supplied with plastic retail hangers
- Sold 6 per inner pack/6 per outer pack



**QLT** by MARSHALLTOWN

Item	Part No.	Style	Size-in.	Size-mm
510805	MT19088	Wide London	12 5/8	305 X 146

## CORNER

### Inside Corner Trowel

- Formed from a single piece of stainless steel
- Blade flexes to form a perfect 90 degree angle
- Used to embed tape and smooth out the final layer of mud to taped corners
- Comfortable soft grip handle
- Sold 1 per inner pack/6 per outer pack



**QLT** BY MARSHALLTOWN

Item	Part No.	Size-in.	Size-mm
506538	MTCT911	4 X 5	102 X 127

### Inside Corner Trowel

- Lightweight tool made from one piece of flexible stainless steel with aluminium mounting
- Blade set at a 103° angle that flexes to form a perfect 90° corner during use
- Resilient DuraSoft® handle with finger guard
- Used to embed tape and smooth out the final layer of mud to taped corners
- Sold 2 per inner pack/48 per outer pack



MADE IN U.S.A

U.S. Patent Nos. 5,327,612 and 5,446,941

**MARSHALLTOWN The Premier Line**

Item	Part No.	Size-in.	Size-mm
506446	MT23D	4 X 5	102 X 127

### EIFS Outside Corner Trowels

- Lightweight tool made from one piece of 4 1/4" (108mm) long stainless steel
- Has a 90° angle between the blades
- Resilient DuraSoft® handle with integral finger guard
- Designed to be used with the inside corner trowels for finishing decorative details
- Sold 2 per inner pack/2 per outer pack



MADE IN U.S.A

U.S. Patent Nos. 5,327,612 & 5,446,941

**MARSHALLTOWN The Premier Line**

Item	Part No.	Size-in.	Size-mm
506491	MT5769D	2	51

### EIFS Inside Corner Trowels

- Lightweight tool made from one piece of 4 1/4" (108mm) long stainless steel
- Has a 90° angle between the blades
- Resilient DuraSoft® handle with integral finger guard
- Designed to be used with the outside corner trowels for finishing decorative details
- Sold 2 per inner pack/2 per outer pack



MADE IN U.S.A

U.S. Patent Nos. 5,327,612 & 5,446,941

**MARSHALLTOWN The Premier Line**

Item	Part No.	Size-in.	Size-mm
506493	MT5788D	2	51

## POINTING

### Pointing Trowels

- Durable construction
- Perfect for projects of any size
- Designed for repeated use but priced for the Do-It-Yourselfer
- Soft grip handle for increased comfort
- Sold 6 per inner pack/6 per outer pack



**QLT** BY MARSHALLTOWN

Item	Part No.	Size-in.	Size-mm
506606	MTPTSG525	5 X 2 1/2	127 X 64

### Philadelphia Style Pointing Trowels

- Forged from a single piece of high carbon steel for unsurpassed strength
- Resilient DuraSoft® handle with integral finger guard
- Sold 6 per inner pack/6 per outer pack



MADE IN U.S.A

U.S. Patent Nos. 5,327,612 & 5,446,941

**MARSHALLTOWN The Premier Line**

Item	Part No.	Size-in.	Size-mm	Handle
506476	MT45/6DH	6 X 2 3/4	152 X 70	

## TUCK POINTER

### Tuck Pointers

- Durable construction
- Perfect for projects of any size
- Designed for repeated use but priced for the Do-It-Yourselfer
- Soft grip handle for increased comfort
- Sold 6 per inner pack/6 per outer pack



**QLT** BY MARSHALLTOWN

Item	Part No.	Size-in.	Size-mm
506629	MTTPSG38	6 X 3/8	152 X 10

**FINISHING**

**Stainless Steel**

- Highest grade hardened and tempered bright or golden stainless steel blade, properly shaped
- Aluminium alloy Xtralite® mounting is lightweight but very strong
- Choice of resilient DuraSoft® handle or smooth, natural finish hardwood handle
- Sold 1 per inner pack/12 per outer pack, 6 per outer pack where noted with \*



506566



U.S. Patent No. 5,522,111

**MARSHALLTOWN The Premier Line**

**Bright Stainless Steel**

Item	Part No.	Size-in.	Size-mm	Handle
510909	MTMXS3SSDH	11 X 4¾	279 X 121	
506593	MTMXS73SSH	14 X 4¾	356 X 121	
506585	MTMXS66SSD	16 X 4	406 X 102	
506590	MTMXS73SDH	14 X 4¾	356 X 121	
506579	MTMXS25SSD*	20 X 5	508 X 127	



U.S. Patent No. 5,522,111

**MARSHALLTOWN The Premier Line**

**Golden Stainless Steel**

Item	Part No.	Size-in.	Size-mm	Handle
506575	MTMXS13GSD	13 X 5	330 X 127	
506588	MTMXS73GSD	14 X 4¾	356 X 121	

**Stainless Steel**

- Cast aluminium mounting securely riveted to tempered, polished steel blade
- Mounting has a square shank to prevent handle from turning
- Soft grip handle for increased comfort
- Sold 1 per inner pack/6 per outer pack



**OLT** BY MARSHALLTOWN

Item	Part No.	Size-in.	Size-mm	Handle
506546	MTFT124SS	12 X 4	305 X 102	

**High Carbon Steel - DuraSoft® Handle**

- Highest grade hardened and tempered spring steel blade, properly shaped
- Aluminium alloy Xtralite® mounting is lightweight but very strong
- Beveled work edges prevent surface aggregate popping
- Resilient DuraSoft® handle provides a soft feel, reduces fatigue and offers excellent durability
- Sold 1 per inner pack/12 per outer pack, 6 per outer pack where noted with \*



U.S. Patent No. 5,522,111

**MARSHALLTOWN The Premier Line**

Item	Part No.	Size-in.	Size-mm	Handle
506581	MTMXS3D	11 X 4¾	279 X 121	
506587	MTMXS73DH	14 X 4¾	356 X 121	
506583	MTMXS66D	16 X 4	406 X 102	
506594	MTMXS77DH*	18 X 4½	457 X 114	



## High Carbon Steel - Wood Handle

- Highest grade hardened and tempered spring steel blade, properly shaped
- Aluminium alloy Xtralite® mounting is lightweight but very strong
- Beveled work edges prevent surface aggregate popping
- Sold 1 per inner pack/12 per outer pack

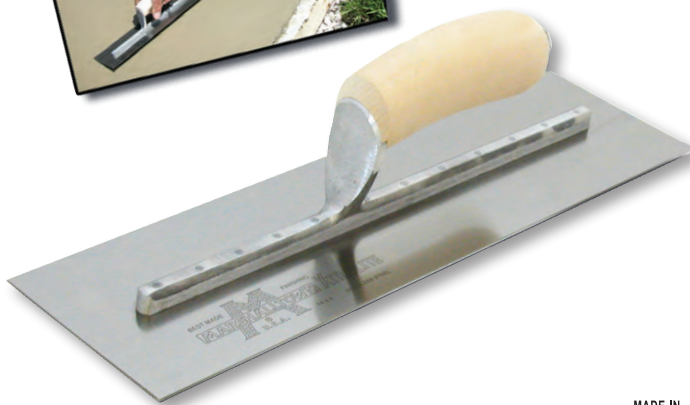

MADE IN U.S.A.

### MARSHALLTOWN The Premier Line

Item	Part No.	Size-in.	Size-mm	Handle
506589	MTMXS73H	14 X 4¾	356 X 121	

## High Carbon Steel

- Cast aluminium mounting securely riveted to tempered, polished steel blade
- Mounting has a square shank to prevent handle from turning
- Soft grip handle for increased comfort
- Sold 1 per inner pack/6 per outer pack



### QLT<sup>®</sup> by MARSHALLTOWN

Item	Part No.	Size-in.	Size-mm	Handle
506547	MTFT144	14 X 4	356 X 102	
506548	MTFT164	16 X 4	406 X 102	

## PermaShape® "Flat"

Stainless Steel!

- Guaranteed to stay flat use after use
- Made from highest grade stainless steel
- Properly shaped and tempered
- Withstands pressure of hard-troweling
- Flat blade makes applications easier with more consistent finish
- Resilient DuraSoft® handle or smooth, natural finish hardwood handle
- Sold 1 per inner pack/12 per outer pack



MADE IN U.S.A.

U.S. Patent Nos. 5,522,111; 5,697,265; and 5,791,009

### MARSHALLTOWN The Premier Line

Item	Part No.	Size-in.	Size-mm	Handle
506465	MT3SSFPD	11 X 4¾	279 X 121	
506418	MT13SSFPD	13 X 5	330 X 127	
506505	MT73SSFPD	14 X 4¾	356 X 121	

## PermaShape® "Flat"

Golden Stainless!

- Guaranteed to stay flat use after use
- Made from highest grade stainless steel
- Properly shaped and tempered to a golden finish
- Withstands pressure of hard-troweling
- Flat blade makes applications easier with more consistent finish
- Choice of resilient DuraSoft® handle or smooth, natural finish hardwood handle
- Sold 1 per inner pack/12 per outer pack, 6 per outer pack where noted with \*



MADE IN U.S.A.

U.S. Patent Nos. 5,522,111; 5,697,265; and 5,791,009

### MARSHALLTOWN The Premier Line

Item	Part No.	Size-in.	Size-mm	Handle
511116	MT7GSFP	12 X 5	305 X 127	
506417	MT13GSFPD	13 X 5	330 X 127	
511117	MT145GSFP	14 X 5	356 X 127	
506425	MT145GSFPD	14 X 5	356 X 127	
511118	MT165GSFP*	16 X 5	406 X 127	

MARSHALLTOWN The Premier Line

## DuraFlex Trowels

*Golden Stainless!*

- PermaShape® guarantees trowel will maintain original flat shape
- Flat, yet flexible thinner blade makes applications easier with more consistent finish. Great for EIFS applications
- Available with a long or short mounting which allows for more flexibility
- Highest grade, hardened and tempered, golden stainless steel blade, properly shaped and fastened with stainless steel rivets
- Withstands pressure of hard-troweling
- Sold 1 per inner pack/12 per outer pack



**MOST FLEXIBLE TROWEL AVAILABLE**

MADE IN U.S.A

U.S. Patent Nos. 5,697,265; 5,522,111; 5,791,009

### MARSHALLTOWN The Premier Line

Item	Part No.	Mounting	Blade-in.	Blade-mm	Handle
506477	MT4681DFDL	9¾" (248mm)	13 X 5	330 X 127	

## GAUGING

### Gauging Trowels

- Forged from a single piece of high carbon steel
- Carefully taper ground and polished
- Many uses, including mixing or "gauging" small quantities of mortar or quick setting plaster
- Resilient DuraSoft® handle with integral finger guard
- Sold 12 per inner pack/12 per outer pack



MADE IN U.S.A

U.S. Patent Nos. 5,327,612 & 5,446,941

### MARSHALLTOWN The Premier Line

Item	Part No.	Size-in.	Size-mm	Handle
506482	MT48DH	7 X 3¾	178 X 86	

### Gauging Trowel

- Durable construction
- Perfect for projects of any size
- Designed for repeated use but priced for the Do-It-Yourselfer
- Soft grip handle for increased comfort
- Sold 1 per inner pack/12 per outer pack



**QLT** MARSHALLTOWN

Item	Part No.	Size-in.	Size-mm
506550	MTGTSG735	7 X 3¾	178 X 86

## MIDGET

### Midget Trowels

- Aluminium alloy Xtralite® mounting is lightweight but very strong
- "SS" indicates a stainless steel blade
- Resilient DuraSoft® handle
- Sold 3 per inner pack/3 per outer pack



MADE IN U.S.A

U.S. Patent No. 5,522,111

### MARSHALLTOWN The Premier Line

Item	Part No.	Size-in.	Size-mm	Handle
506407	MT11D	8 X 3	203 X 76	
506408	MT11SSD	8 X 3	203 X 76	

## POOL

### Golden Stainless Steel Pool Trowels

- Highest grade hardened and tempered golden stainless steel blade, properly shaped and fastened with stainless steel rivets
- Short aluminium alloy Xtralite® mounting is lightweight but very strong
- Blade is flexible enough to bend to almost any radius
- Sold 1 per inner pack/12 per outer pack, 6 per outer pack where noted with \*



MADE IN U.S.A

U.S. Patent No. 5,522,111

### MARSHALLTOWN The Premier Line

Item	Part No.	Rivets	Size-in.	Size-mm	Handle
506621	MTSP10GSD	3	10 X 3	254 X 76	
506622	MTSP12GSD	5	12 X 3½	305 X 89	
506623	MTSP14GSD	6	14 X 4	356 X 102	
510808	MTSP16GSD*	8	16 X 4½	406 X 114	



# trumeter

innovation by design

## COUNTING, MEASURING & TIMING

*Trumeter is a UK based designer, manufacturer and distributor of sophisticated measuring instruments. Their engineers design and invent innovative products that meet and exceed customer's specifications and expectations.*

### **Distance Measurement:**

*For over half a century Trumeter has been designing and manufacturing distance measuring products of world class quality. The product applications are numerous and include: surveying, road and construction measurement, land measurement, stadia measurement, indoor measurement and rail track measurement.*

### **Length Measurement:**

*This range of products was the original innovation by Trumeter in the 1930's . Today the product range is used in an extensive number of industries including textile, carpet, wallpaper, timber and cable measurement.*













## **SPECIALISING IN:**

**Counting & Measuring Instruments • Revolution Counters  
Specialist Counters • Length & Distance Measurers**



#### **TERMS AND CONDITIONS**

All products are warranted against faulty workmanship or materials for 12 months, except the TRU5000, TRU5500 & TRU5500E that are warranted for 2 years. Condition is that they are used as the manufacturer intended. Specifications for counters are shown in the Trumeter Catalogue or website [www.trumeter.com](http://www.trumeter.com) Road measurers are to be used at human speed only (not outside car doors whilst doing 40km/hr).

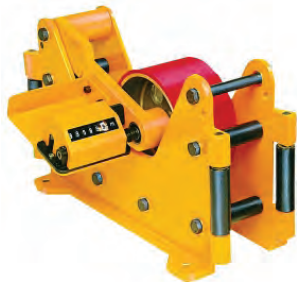
PART NO.	ITEM	DESCRIPTION	IMAGE
<b>MEASURING WHEELS</b>			
<b>ROAD MEASURING WHEELS</b>			
<b>TRU5000</b>	<b>709954</b>	<b>PROFESSIONAL ROAD MEASURER</b> Display: 99999.9m With built in fold away stand and brake Superbly balanced - the first choice for professionals Precision measuring wheel with accuracy of +/- 1% Large display with 7mm high characters Adds forward and subtracts in reverse Lever resets to zero Pointer indicates start position Robust construction, including mud scraper Folding handle with locking clip for easy carriage Oil resistant precision made tyre 1m circumference (314.2mm dia.) measuring wheel Ideal for mining as it contains no aluminium Includes carry bag	
<b>TRU5500</b>	<b>709956</b>	<b>MEASUREMETER - Mechanical</b> Display: 99999.9m Trumeter's highly affordable Measuremeter Robust ABS construction Precision measuring wheel with accuracy of +/- 1% 1m circumference (314.2mm dia.) measuring wheel Large display with 7mm high characters Adds forward and subtracts in reverse Retractable stand Telescopic handle for easy carriage Built in brake and mud scraper Pointer indicates start position	
<b>TRU5500E</b>	<b>709957</b>	<b>MEASUREMETER - Electronic</b> Display: 99999.9m Patented Electronic Counter with gold plated contacts Precision measuring wheel with accuracy of +/- 1% Huge Backlight LCD display with 14mm high numbers Counts to the millimetre LCD is crystal clear in direct sunlight Adds forward and subtracts in reverse Minimum 5 year battery life, weather and moisture proof otherwise 2 year warranty Measure trip and total at same time, push button reset Otherwise as per TRU5500 (same ABS frame, handle and wheel)	
<b>RAIL MEASURING WHEEL</b>			
<b>TRU5061</b>	<b>709955</b>	<b>RAIL TRACK MEASURER</b> Display: 9999.9m The only choice for accurate, reliable rail track measurement. Integral side plates to fit over railway tracks and ensure stability. Heavy Duty counter with large 7mm numbers. Adds forwards and subtracts in reverse. Precision measuring wheel with accuracy of +/- 1%. Built in declutch mechanism.	

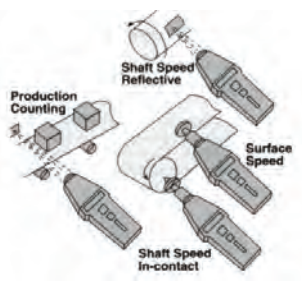
PART NO.	ITEM	DESCRIPTION	IMAGE
<b>REVOLUTION COUNTERS &amp; LENGTH MEASUREMENT ASSEMBLIES</b>			
<p>DEFINITION OF TERMS:            All counters are Top Viewing.            All have 6.4mm high numbers unless otherwise specified.            Reset position is customer selective            Ratio of 2:1 = 2 turns of shaft is a count of 1 on the display.            TC = Top Coming - refer to illustration on the right            TG = Top Going - refer to illustration on the far right            m = Metres</p>		 <p>Top Coming (TC)</p>	 <p>Top Going (TG)</p>
<b>SHAFT DIRECTION FOR COUNTER TO COUNT UP. (1, 2, 3, ETC)</b>			
The base plate dimensions are 111 x 65mm and the overall height is 46mm. The shaft diameter is 7mm ( 0.275").			
		RATIO	DISPLAY
<b>TRU3602-001TC</b>	<b>709947</b>	1 : 1	999999m
<b>TRU3602-001TG</b>	<b>709948</b>	1 : 1	999999m
<b>TRU3602-192TC</b>	<b>709949</b>	2 : 1	99999.9m
<b>TRU3602-192TG</b>	<b>709950</b>	2 : 1	99999.9m
<b>TRU3602-193TC</b>	<b>709951<sup>^</sup></b>	3 : 1	9999.9m
<b>TRU3602-193TG</b>	<b>709952</b>	3 : 1	9999.9m
<b>WHEELS</b>			
0.5 metre circumference for use with 2 : 1 counters 0.33 metre circumference for use with 3 : 1 counters			
<b>TRUC7574-1</b>	<b>709966</b>	0.5m Rubber covered plastic wheel	 <p>TRU3602-001TC</p>  <p>TRU3602-001TC + TRUD5697-1 + 2 x TRUC7574-1</p>  <p>TRU3602-001TC + TRUD5697-3 + 1 x TRUC7574-1</p>  <p>TRU3602-001TC + TRUD5697-3 + 2 x TRUC7574-1</p>
<b>TRUC1862-1</b>	<b>709963<sup>^</sup></b>	0.5m Knurled aluminium wheel	
<b>TRUC7905-1</b>	<b>709967<sup>^</sup></b>	0.33m Rubber covered plastic wheel	
<b>TRUC2626-1</b>	<b>709965<sup>^</sup></b>	0.33m Knurled aluminium wheel	
<b>BRACKET ASSEMBLIES</b>			
<b>TRUD5697-1</b>	<b>709970<sup>^</sup></b>	Bracket only mounted	
<b>TRUD5697-3</b>	<b>709972<sup>^</sup></b>	Bracket with stand (shaft length is 450mm)	
<p>Make up your own Length measurement assembly simply by selecting a revolution counter with 2 : 1 or 3 : 1 ratio, and then select the Wheel to suit and Bracket Assembly you desire. All mounting screws etc. are included.</p>			
<b>LENGTH MEASURING MACHINE</b>			
<b>TRU2600</b>	<b>709940<sup>^</sup></b>	<p><b>HEAVY DUTY MULTI PURPOSE MEASURING MACHINE</b>            This machine measures the length of cable, wire, rope, hose, extrusions or continuous strip from 6mm to 76mm in diameter.            Display: 9999.9m</p>	

PART NO.	ITEM	DESCRIPTION	IMAGE
<b>DIGITAL HAND TACHOMETER</b>			
<b>TRU4HT600</b>	<b>709953</b>	<p><b>5 Digit Microprocessor based, Battery powered Hand-held Tachometer/Counters with Data memory</b></p> <ul style="list-style-type: none"> <li>- RPM, speed and distance measurement</li> <li>- 5 Digit 10mm high contrast LCD display</li> <li>- Fixed or floating decimal point</li> <li>- Comprehensive set of annunciators indicate mode, range and memorised data</li> <li>- Rugged design, fits comfortably in the hand</li> <li>- Accurate to + or - 0.02%</li> <li>- Measures rotation speed down to 1 RPM</li> <li>- Automatic power saving shut off and display memory recall of the 3 readings being the last, maximum and minimum</li> <li>- Low battery indicator</li> </ul> <p><b>SPECIFICATIONS</b></p> <p>Display: 5 digit 10mm high contrast LCD, floating decimal pt.</p> <p>Measurement Ranges</p> <p>Rotation: 1-99,999RPM (contact and non-contact)</p> <p>Speed: 0.1-1,999m/min, 0.3-6,500ft/min or 4.0-78,000in/min according to the measuring wheel</p> <p>Accuracy: + or - 0.02%</p> <p>Measurement Time: 0.5 sec or one period</p> <p>Non-Contact Measurement Distance: 350mm optimum</p> <p>Readings in Memory: Last Reading, and maximum and minimum reading of last measurement</p> <p>Power Source: 2x1.5V Type AA Batteries</p> <p>Auto Power-Off: 30sec after last operation</p> <p>Operating Temp: -10°C to 50°C</p>	 

<b>TOTALISING COUNTERS</b>			
<b>TRCHTC</b>	<b>709915</b>	<p><b>HAND TALLY</b></p> <p>4 Digit tally counters number clicker</p> <p>Stainless Steel</p> <p>Display to 9999</p>	 
<b>TRCDTC</b>	<b>709914</b>	<p><b>DESK TALLY</b></p> <p>4 Digit tally counters number clicker</p> <p>Stainless Steel with Plastic Base</p> <p>Display to 9999</p>	

TRCHTC

TRCDTC

# Avancer UK

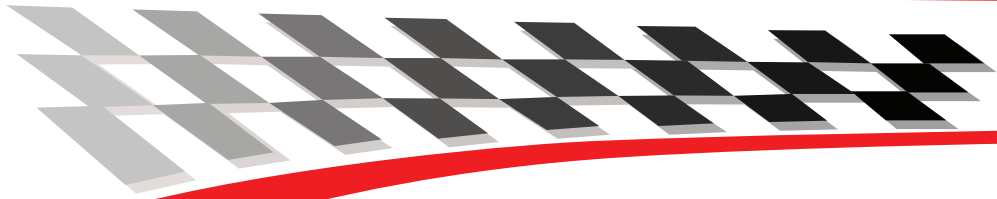

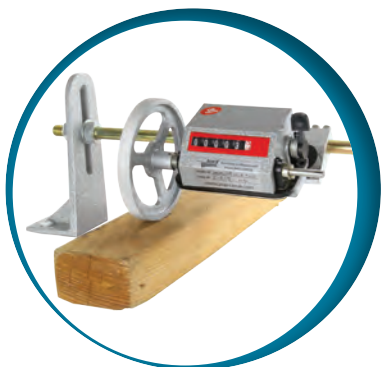
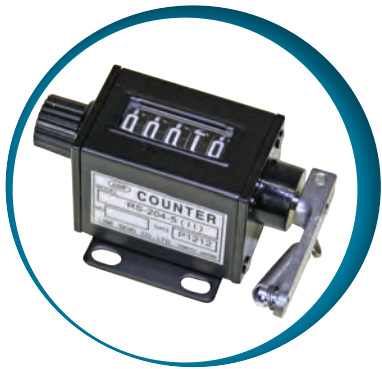

[www.avanceruk.com](http://www.avanceruk.com)



**Avancer UK  
are manufacturers of:  
Compact Stroke  
Counters,  
Mechanical Stroke  
Counters  
and Timber Measurers.**



PART NO.	ITEM	DESCRIPTION	BARCODE	IMAGE
<b>COUNTERS</b>				
<b>COMPACT STROKE COUNTER</b>				
AVA CSJ5 TC RH	800287	CS J5 TOP COMING RIGHT HAND LEVER RESET COMPACT STROKE COUNTER		 <p>40 X 25 X 30H Approximate Size</p>
AVA CSJ5 TG RH	800312	CSJ5 TOP GOING RIGHT HAND LEVER RESET COMPACT STROKE COUNTER		
AVA CSJ5 TC LH	800313	CSJ5 TOP COMING LEFT HAND LEVER RESET COMPACT STROKE COUNTER		
AVA CSJ5 TG LH	800314	CSJ5 TOP GOING LEFT HAND LEVER RESET COMPACT STROKE COUNTER		
<b>MECHANICAL STROKE COUNTER</b>				
AVA CS66 TC RH	800316	CS6 TOP COMING RIGHT HAND LEVER RESET MECHANICAL STROKE COUNTER		 <p>80 X 65 X 45H Approximate Size</p>
AVA CS6 TG RH	800318	CS6 TOP GOING RIGHT HAND LEVER RESET MECHANICAL STROKE COUNTER		
AVA CS6TCLH	800315	CS6 TOP COMING LEFT HAND LEVER RESET MECHANICAL STROKE COUNTER		
AVA CS6 TG LH	800317	CS6 TOP GOING LEFT HAND LEVER RESET MECHANICAL STROKE COUNTER		
<b>TIMBER MEASURER</b>				
AVA 2901	800319	<b>2901 TIMBER MEASURER</b> This machine measures at the instant the timber makes contact with the spring loaded measuring wheel. It has a friction brake to prevent over spin (once the timber has passed through the measurer, the counter stops waiting for the next piece of timber). It is supplied with an adjustable height stand for different timber thickness. A Heavy Duty 3:1 ratio revolution counter is included.		









## Fibreglass Tape Measures

“Eslon” Fibreglass tape Measures are made in Japan and have the highest strength, lowest elongation of any tape sold on the Australian market. Every tape is overcoated polyvinyl chloride (PVC) to give the tapes superior durability and added protection to the markings on the tape.

Extensive testing is done on all production batches to ensure compliance with strict Japanese Standards for tape accuracy.



PART NO.	ITEM	DESCRIPTION	BARCODE	IMAGE
<b>TAPE MEASURES</b>				
<b>PVC Coated Fibreglass Tape Measures.</b>				
<p><b>Accuracy:</b> Eslon PVC coated fibreglass tape measures are the most accurate fibreglass tape measure made. The tape is made from 30,000 pieces of glass fibre placed in parallel and covered with resilient polyvinyl chloride. The tape is unaffected dimensionally by water and other liquids, or by creasing.</p> <p><b>Durable:</b> Eslon beats any other kind of tape for toughness. It can take any amount of rough treatment-trampling, mud, abrasion from rocks, even being run over by trucks and will go on taking it year after year.</p> <p><b>Non-Conducting:</b> A fibreglass tape is ideally suited for use where electrical hazards exist, as both fibreglass and polyvinyl chloride are of a non-conductive nature.</p> <p><b>Cleaning:</b> A fibreglass tape is problem free, no mildew or rust to worry about. With Eslon stains can be wiped off with soap and water.</p>				
<b>CLOSED CASE - FIBREGLASS TAPE</b>				
PVC coated fibreglass tapes in high impact ABS closed case.				
ESM10MM	502113	FIBREGLASS TAPE 10MTR X 12MM CLOSED CASE (M1 / M2)	4906648073276	
ESM20MM	502116	FIBREGLASS TAPE 20MTR X 12MM CLOSED CASE (M1 / M2)	4906648073283	
ESM30MM	502118	FIBREGLASS TAPE 30MTR X 12MM CLOSED CASE (M1 / M2)	4906648073290	
ESM100FM	502112	FIBREGLASS TAPE 30MTR/100FT CLOSED CASE (M1 / F1)	4906648073337	
<b>NON-CONDUCTIVE</b>				
<p>High accuracy measure perfected from all angles. Expansion-free fibreglass tape with special plastic coating. Latest upright design with automatic winding. Large figures for easy reading with continuous figures on entire length. The tape is made from fibreglass reinforced plastic with a urethane coating. The case is compact and made of lightweight, rigid ABS resin with no metal used. Excellent oil resistance, waterproofing and solvent resistance. Exceptional accuracy compared to that of a steel tape. Tape length – 3 mtr, Width 19mm, Thickness 0.3mm. Scale accuracy – 3mtr +/- 0.9mm (JIS Class 2). Elongation 2.5% (breaking extension) – tensile strength 100kgf. Insulation performance – Dry 20kV or over 10cm, Wet 20Kv or over 10 cm</p>				
ESZ3NGC	502141	POCKET TAPE 3MTR NON-CONDUCTIVE	4906648089475	
<b>RAPID REEL - FIBREGLASS TAPE</b>				
Fibreglass open reel measuring tape. Extremely accurate. Rapid wind feature allows the recovery of the tape 3 times faster than a conventional open reel tape. Speedy tape retraction greatly improves the work efficiency of measuring.				
ESHR30MM	502110	FIBREGLASS TAPE 30M X12MM RAPID REEL (M1 / M2)	4906648073467	
ESHR50MM	502111	FIBREGLASS TAPE 50M x 0.5MM x 12MM RAPID REEL (M1/M 2)	4906648073375	
ESHR165FM	502109	FIBREGLASS TAPE 50M/165FT x 12MM RAPID REEL (M1 / F1)	4906648073382	
<b>OPEN REEL - FIBREGLASS TAPE</b>				
P.V.C. coated fibreglass tapes in ABS open reel case.				
ESR100MM	502126	FIBREGLASS TAPE 100Mx12MM ABS OPEN REEL (M1 / M2)	4906648073351	

**Patterns in 0 (zero) Point**  
0 point starts from the inside edge of metal hook

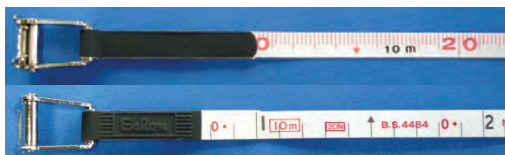

**Tape Marking**  
M1: Metric , m, cm, 2mm (Eslon Standard)  
F1: Ft-inches, 1/8ths (Eslon Standard)



# *Precision Power Tools*

THE BENCHMARK IN PRECISION POWER TOOLS  
FOR OVER 35 YEARS

The remarkable Triton Woodworking System is now available.

Precision has been at the heart of Triton's philosophy since 1976 when the first Workcentre was produced. From design through to the completed product, Triton engineering is all about precision and it's this attention to detail that makes using Triton tools a pleasure and gives us the satisfaction of knowing we have played a part in the final finish of your project.

At the core of the Triton range is the Series 2000 Workcentre. Safe, accurate and easy to use, the versatility of the Workcentre means it can be moved easily around the workshop or folded up for storage or transport to the job.  
Australian innovation at its best.





Precision has been at the very heart of Triton's philosophy since 1976, when the first Workstation was produced, and this philosophy continues to drive the design and development of every Triton product. For tools you can rely on for the very best quality finish and highest levels of accuracy, Triton tools ensure every project is finished to the most exacting standards.

## Compact Precision Plunge Router 1010W

- Collets: 1/2" & 1/4"
- Through-base, single-spanner action bit change with automatic spindle lock
- Variable speed, soft start & safety switch
- Free plunge & micro winder
- Dust extraction port



## Dual Mode Precision Plunge Router 1400W

- Collets: 1/2" & 1/4"
- Through-base, single-spanner action bit change with automatic spindle lock
- Variable speed, soft start & safety switch
- Free plunge, handle winder plunge & micro adjuster
- Dust extraction port



## Dual Mode Precision Plunge Router 2400W

- Collets: 1/2" & 1/4"
- Through-base, single-spanner action bit change with automatic spindle lock
- Variable speed, soft start & safety switch
- Free plunge, handle winder plunge & micro adjuster
- Dust extraction port



Item	Part No.	Description
801219	TRI-JOF001	Compact Precision Plunge Router 1010W

Item	Part No.	Description
801229	TRI-MOF001	Dual Mode Precision Plunge Router 1400w

Item	Part No.	Description
801405	TRI-TRA001	Dual Mode Precision Plunge Router 2400w

## Accessories Kit

- Machined & plated brass guide bushes in 7 popular sizes
- Dust chute for efficient chip extraction beneath the cut
- Compatible with Triton MOF001, JOF001 & TRA001 Precision Plunge Routers



Item	Part No.	Description
801404	TRI-TGA150	Template Guide Kit

## ALL OUR TRITON ROUTERS HAVE:



**Soft Start & Variable Speed** provides the perfect speed for all cutter types



**Quick Access Brushes** allows the user to change worn brushes



**3 Stage Turret** with direct reading scales for precise preset cut depths

Technical Specification	Compact Precision Router 1010W	Dual Mode Precision Plunge Router 1400W	Dual Mode Precision Plunge Router 2400W
Power	1010W	1400W	2400W
Speed	8000 - 20,000rpm speed maintenance under load	8000 - 20,000rpm speed maintenance under load	8000 - 20,000rpm speed maintenance under load
Soft Start	Yes	Yes	Yes
Electronic Speed Maintenance	Yes	Yes	Yes
Collet	1/2" & 1/4"	1/2" & 1/4"	1/2" & 1/4"
Depth Adjustment	Micro winder & conventional 'free' plunge	Winder handle rack and pinion, micro winder & conventional 'free' plunge	Winder handle rack and pinion, micro winder & conventional 'free' plunge
Plunge Range	0 - 59mm	0 - 59mm	0 - 68mm
Micro Adjustment	Infinite	Infinite	Infinite
Spindle Lock	Auto	Auto	Auto
Safety Power Switch	Yes	Yes	Yes
Guide	Extended baseplate with adjustable fence	Extended baseplate with adjustable fence	Extended baseplate with adjustable fence
Weight	3.9kg	4.7kg	6kg
Accessories	Table Height Winder handle & Multi-Function Fence	Table Height Winder handle & Multi-Function Fence	Table Height Winder handle & Multi-Function Fence

## Belt Sander 76mm

- Powerful 1200W motor provides power for the toughest wood surfaces
- Variable speed control improves versatility
- Small diameter front roller allows sanding in confined areas
- Adjustable bail handle increases support & safety



**Variable Speed Control**  
improves versatility when working with different workpieces

**Rubber Over-Moulded Grip**

offers increased support, safety & control of the tool

**Small Diameter Front Roller**

for sanding in confined areas of detailed work



Technical Specification	
Power	1200W
No Load Speed	200 - 450m/min
Belt Size	76 x 533mm
Actual Sanding Area	76 x 150mm
Variable Speed	Yes
Gear Casing	Aluminium
Weight	4.8kg
Included Accessories	
Dust Bag, Sanding Belt & Inversion Clamps	

Item	Part No.	Description
801351	TRI-TA1200BS	Belt Sander 76mm 1200w

## 64mm Palm Sander 450W

- Quick-release belt lever
- Sands to edge of workpiece
- Rubber over-moulded grip
- Small diameter front roller
- Belt tracking adjustment

**Power On-Off**  
to reduce user fatigue

**Rubber Over-Moulded Grip**  
increases control & safety

**Dust Extraction Port**  
for a cleaner, safer working environment



Fits neatly in the palm for single handed use



**Small Diameter Front Roller**  
allows sanding in confined areas

**Belt Tracking Adjustment**  
enables the sanding belt to be re-centred



Technical Specification	
Power	450W
No Load Speed	340m/min
Belt Size	64 x 406mm
Weight	2.1kg
Included Accessories	
3 x Sanding Belts 60 grit (1 fitted), Dust Extraction Adaptor	

Item	Part No.	Description
801368	TRI-TCMSB	Palm Sander 64mm 450w

## Oscillating Spindle Sander 450W

- Large 370 x 295mm cast iron table for stability & enhanced material support
- Enables precise finishing of intricate work
- Includes 6 sanding sleeves 13-76mm dia with matching drums & table inserts
- On-board storage for all accessories
- Dust port for connection to extraction system

Precision Power Tools

Technical Specification	
Power	450W
No Load Speed	2000rpm
Oscillations	58opm
Table Size	370 x 295mm
Dust Port	38mm
Weight	12.9kg
Included Accessories	
6 x Aluminium Oxide Sanding Sleeves from 13 - 76mm, 6 x Table Inserts, 5 Rubber Sanding Drums, 3 x Upper Spindle Washers & 1 x Wrench	



Item	Part No.	Description
801498	TRI-TSPS450	Oscillating Spindle Sander 450w
801502	TRI-TSS60G	6pc Sleeves 60 Grit
801503	TRI-TSS80G	6pc Sleeves 80 Grit
801499	TRI-TSS100G	6pc Sleeves 100 Grit
801500	TRI-TSS150G	6pc Sleeves 150 Grit
801501	TRI-TSS240G	6pc Sleeves 240 Grit



## Precision Power Saw 235mm

- Smooth, powerful 2400W motor
- Accurate calibration scale & blade bevel trimmer
- Quick-action bevel stops at 0°, 15°, 22.5°, 30° & 45°
- Strong, die-cast aluminium baseplate
- Heavy-duty height adjustment assembly

Technical Specification	
Power	2400W (3 1/4hp)
No Load Speed	4100rpm
Blade	235mm
Blade Arbor	16 or 25mm
Bevel Adjustment	0 - 45°
Cutting Depth	0° - 82mm 45° - 58mm
Weight	8kg
Included Accessories	
Rip Fence, 40 TCT blade, Blade Spanner	



Item	Part No.	Description
801456	TRI-TSA001	Circular Saw 235mm 2400w

# SUPERJAWS

## SuperJaws Portable Clamping System

- Robust, all-steel construction with powder-coated finish
- Foot-operated up to 1000kg clamping
- Reversible jaw enables clamping up to 956mm
- Extra-wide tripod base for stability
- Size: 980 x 1000 x 860mm



Quickly Folds Down for storage and transport



Urethane Jaw Facings provide a protective, slip-resistant grip



Lock / Release Switch allows fast, trouble-free release of the jaws



Extra-Wide Tripod Base for all-terrain stability

Robust, All-Steel Construction with powdercoat finish for long-lasting operations



Foot operated hands-free clamping up to 1000Kg

frees up your hands for full control of the job



Technical Specification	
Clamping Range	0 - 956mm
Clamping Force	Up to 1000kg
Clamping Method	Foot Operated
Standard Jaws	Urethane
Max. Load	100kg
Folding Time	20 seconds approx.
Folded Size	275 x 775 x 295mm
Standing Size	980 x 1000 x 860mm
Weight	16kg
Optional Accessories	
801321	SJA460 Log Jaws
801322	SJA470 Engineers Jaws
801320	SJA420 Tool Tray/Work Support

Item	Part No.	Description
801269	TRI-SJA200	SuperJaws Mk2

### Log Jaws

- Strong jaws for working on logs & poles up to approx 300mm dia
- Ideal for chainsawing, drilling, fastening or carving work
- Serrated teeth prevent slippage or rolling
- Fits easily on SuperJaws in place of the standard urethane jaws
- Steel plate & zinc-plated for corrosion resistance
- Compatible with all SuperJaws



### Engineers Jaws

- Shaped for increased grip on metal bars, tubes and piping up to 50mm dia.
- Tough cast iron jaws & anvil face for heavy duty metal work
- Easy to fit & remove
- Compatible with all SuperJaws



### Tool Tray / Work Support

- Provides extra support for large workpieces
- Keeps tools, spare parts or other items conveniently to hand
- Robust & hardwearing
- Easy to fit & remove
- Compatible with Superjaws SJA200



Item	Part No.	Description
801321	TRI-SJA460	Log And Pole Gripping Jaws

Item	Part No.	Description
801322	TRI-SJA470	Cast Engineers Jaws

Item	Part No.	Description
801320	TRI-SJA420	Tooltray Comb Side Support

## Workcentre System Series 2000

- Operates in crosscut & tablesaw modes
- Reversible & adjustable aluminium fence
- Adjustable, clear guard with pressure fingers & riving knife
- Sliding push stick
- Compatible with 185mm – 235mm circular saws
- But works best with 235mm saws

Precision Power Tools



**40**  
Seconds

Switch from Table Saw to Crosscut Saw in **40 seconds!**



### Crosscut Saw Mode



Mitre Saw



Overhead Router  
\* Requires AJA150 Slide Plate



Bevel Saw

### Table Saw Mode



45° Bevel Saw



Mitre Cuts



Router Table  
Requires Router Table RTA300

Technical Specification	
Compatibility	Circular Saws 185 - 235mm
Cuts	Rip, mitre, 45° bevel rip, crosscut, bevel crosscut & compound mitre
Capacities	Rip: 0 - 620mm Crosscut: 0 - 500mm
Sizes	Standing: 900 x 1300 x 600mm Folded: 440 x 1000 x 350mm Table: 870 x 640mm
Weight	35kg (plus power tool)

Item	Part No.	Description
801529	TRI-WCA201	Workcentre Series 2000



## Workcentre Accessories

### Overhead Mounting Kit

- Robust steel construction
- Router slide plate for overhead work
- Suits most routers for cross trenching on the Triton Workcentres
- Offers high accuracy for shelving, cabinets & built-in cupboards

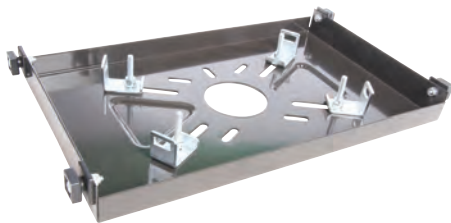

Item	Part No.	Description
801182	TRI-AJA150	Router Mounting Plate

### Blade Height Winder Kit

- Quick, precise blade height adjustment:
  - by winder through the table slot
  - by thumb wheel in crosscut mode
- Allows saw to remain at its full depth
- Compatible with Workcentre System Series 2000



Item	Part No.	Description
801563	TRI-WCA390	Height Winder Kit

### Workcentre Dust Bag

- Easy-to-fit
- Detachable pouch
- Bayonet & tapered hose connectors
- Vacuum hose
- Fits all Triton Workcentres



Item	Part No.	Description
801209	TRI-DCA250	Workcentre Dust Bag

### Planer Attachment Kit

- For perfectly smooth, straight faces
- Includes detachable dust collection bag
- Quick, fold-away action for fast changes between planer & saw modes
- Adjustable pressure fingers
- Separate switch box with safety shut-off
- Suits most 82mm electric planers



Power Tool **NOT** included

Item	Part No.	Description
801211	TRI-EPA001	Planer Attachment Kit

### Bevel Ripping Guide

- Enables accurate bevels & chamfers from 15 - 90°
- Integral calibration for easy alignment
- Fully adjustable to handle long & wide workpieces
- Compatible with Triton Workcentre System 2000



Item	Part No.	Description
801194	TRI-BRA200	Bevel Ripping Guide

### Mini Sliding Extension Table

- Crosscut capacity up to 600mm, rip capacity up to 1000mm
- Easy-to-read calibration scales
- Multi-position fence
- Folds for storage
- Compatible with Triton Workcentres & Saw Tables and Router Stand RSA300



Item	Part No.	Description
801214	TRI-ETA100	Mini Sliding Extension Table

### Maxi Sliding Extension Table

- Cross cut capacity up to 1200mm
- Rip capacity up to 1220mm accommodates 2400 x 1200mm sheets
- Easy-to-read calibration scales
- Table can be locked in position
- Sliding Table acts as panel saw
- Compatible with Triton Workcentres



Item	Part No.	Description
801215	TRI-ETA300	Maxi Sliding Extension Table

## Precision Router Table

- Versatile Router Table System
- Steel Router Mounting Plate accepts most ¼ and ½ inch routers (using the universal brackets included) but particularly suited to the Triton Routers
- Innovative fence system with Micro Adjusters, and clear Safety Gaurd / Dust extraction point
- Sliding table insert with removable protractor
- Accessory range includes Jigsaw Kit, Biscuit Joiner & Finger Jointer
- For use on Triton Workcentres & Router Stands

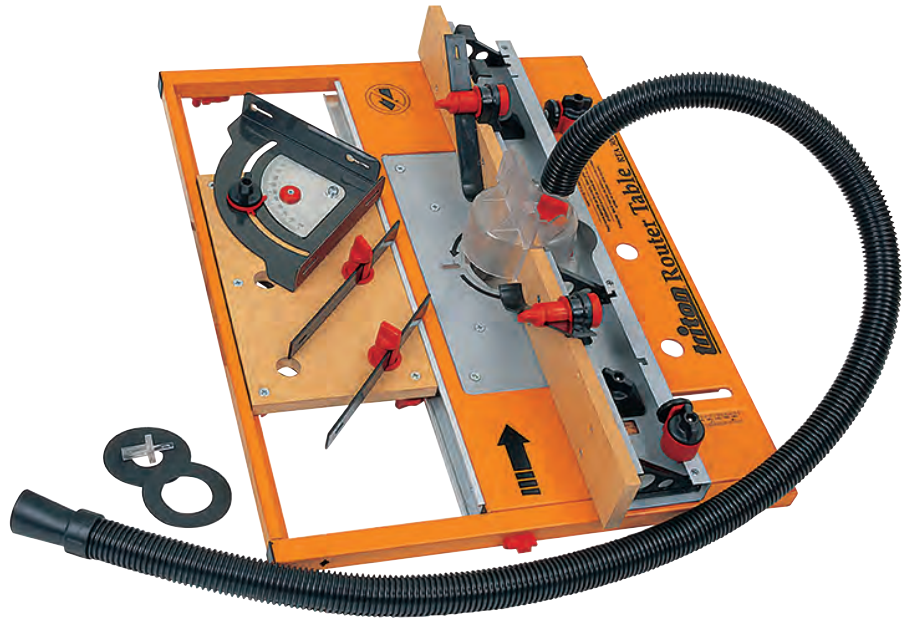

### Technical Specification

Table Size	540 x 690mm
Cuts	Planing, Trenching, Rebating, Moulding, Endgrain Work, Free-hand work
Weight	11kg

### Included Accessories

Planing shims, alignment tool & cutter inserts

Item	Part No.	Description
801245	TRI-RTA300	Router Table



Safe free-hand operation when safety guard is fitted on its own to the table top  
*Router Not Included*



Router Table shown mounted on Triton Workcentre  
*Router Not Included*



Steel frame fence with MDF face  
• faces easily replaced when worn  
*Router Not Included*

## Router Stand

- Safety on/off switch
- Adjustable leg height
- Onboard leg storage
- Folds down for easy transportation
- Compatible with all Triton Router Tables



### Onboard Leg Storage

for easy portability & compact storage

### Power Switch

controls power to the power tool with quick stop panel for added safety

### Adjustable Legs

for easy operation on uneven work surfaces



Folds down for easy transportation and storage



### Technical Specification

Table Size	900 x 700 x 510mm
Standing Size	1055 x 990 x 690mm
Weight	11.4kg

Item	Part No.	Description
801241	TRI-RSA300	Triton Router Stand

## Router Table Accessories

### Finger Jointer

- Creates strong, accurate 1/4" & 1/2" decorative box joints ... 1/2" cutter included
- Suitable for 3 - 32mm board thickness
- Cuts several joints simultaneously
- Dust extraction port
- Compatible with Triton Router Table RTA300



Item	Part No.	Description
801216	TRI-FJA300	Finger Jointer

### Biscuit Joiner

- Ideal for bevel, mitre & edge joinery
- Quick & easy to fit
- Fast, strong & invisible jointing of timber sections
- Includes TCT cutter & pack of biscuits
- Compatible with 1/4" & 1/2" routers
- Compatible with Router Table RTA300



Item	Part No.	Description
801191	TRI-BJA300	Biscuit Joiner

### Jigsaw Kit

- Fast fit and removal from the Triton Router Table. Adjustable hold-down pressure for steady operation.
- Overhead blade stabiliser
- Quick-mount clamps ensure fast removal and re-fitting of the jigsaw
- Dust extraction port for easy connection to a dust collection system
- Suits most jigsaws
- Compatible with Router Table RTA300



Item	Part No.	Description
801183	TRI-AJA300	Jigsaw Kit

### Dust Collection Bucket 20Ltr

- Use with Wet/Dry vacuum
- Prevents sawdust filling up or clogging vacuum cleaners
- 20Ltr capacity
- Easy to handle/empty
- Compatible with most products with dust extraction outlets
- Selection of hose and fittings to connect to vacuum



Item	Part No.	Description
801210	TRI-DCA300	Dust Collection Bucket

## Plunge Track Saw 1400W and Track System

- Mode selector for quick change between free plunge, scribe and blade change modes
- Precision bevel cut adjustment
- Anti kickback safety feature prevents its saw from "jolting" when performing plunge cuts
- Guide rail track lock adds stability when performing bevel cuts
- Easily accessible shaft lock for fast blade-change
- Soft-grip handles for comfort & control
- On-board tool storage
- Universal vacuum system adaptor with 360° rotational outlet

Precision Power Tools



Compatible with Triton Track TTST1500 & other market-leading track systems



Close-to-wall cutting capability (15mm) for expanded applications

Technical Specification	
Power	1400W
No Load Speed	2000 - 5300rpm
Blade	165mm dia 60TCT
Bevel Range	0 - 48°
Cutting Depth	90° - 59mm 45° - 42mm
Weight	5.5kg
Included Accessories	
60 TCT Saw Blade	

### Accessories



Item	Part No.	Description
801518	TRI-TTS1400P	Track Saw Pack

**TRI-TTS1400P Track Saw Kit**  
Includes: Track Saw, Blade, 2 x 700mm tracks 2 x work clamps, saw bag and track bag

## T12 Twin Pack 12V



**Lithium**  
technology

**triton**  
Precision Power Tools



Removable 10mm single sleeve keyless Sanou chuck



**T12 B**  
Samsung ICR 18650 cells & intelligent charging system

1.5Ah Li-Ion Battery



**T12 HCB**  
No memory effect & low self-discharge for maximum productivity & less downtime

3Ah Li-Ion Battery

### Technical Specification

Power	12V
Drill Driver No Load Speed	0 - 400rpm Low / 0 - 1300rpm High
Impact Driver No Load Speed	0 - 2000rpm

### Included Accessories

2 x 1.5Ah Li-Ion Batteries, Battery Charger, Soft Carry Case

Item	Part No.	Description
801350	TRI-T12TP	12v Drill / Impact Driver
801348	TRI-T12ID020	1.5Ah Li-Ion Battery
801334	TRI-T12HCB	3Ah Li-Ion Battery

- **TRI-T12TP - T12 TWIN PACK 12V**
- 1 X 12V Drill Driver (with removable chuck and concealed magnetic bit holder for screwdriver bits)
- 1 X 12V Impact Driver
- 1 x Intelligent fast Charger (80% charge in 30min)
- 2 x 1.5Ah Samsung batteries
- Both drills have Mabuchi RS-500 motors and precision metal gearing
- Built in LED work lights

## Multi-Stand

- Swivelling & tilting head with built-in clamp & low-friction slide surfaces
- Secures work at almost any angle & supports up to 100kg
- Height adjusts from 635 - 940mm
- Extra-wide tripod base for stability
- Folds flat for easy storage

Precision Power Tools



**Angle Adjustment Head**  
with built-in clamping system

**Low Friction Slide Surfaces**  
provides smooth controlled travel without unwanted 'steering'



### Technical Specification

Max. Load	100kg
Height Range	635 - 940mm
Tilt Adjustment	Vertical through horizontal
Weight	6.2kg

Item	Part No.	Description
801230	TRI-MSA200	Multi Stand

## Woodrack Storage System

- Provides generous storage for timber, pipes etc
- For internal or external use
- Ideal for workshops, garages, sheds, fences, walls etc.
- 12 supports provide 6 levels of storage - 50kg per level
- Robust powder-coated steel tubing



Made from 30mm Steel Tubing  
& powder coated for increased durability & life



### Technical Specification

Max. Load	50kg (per level)
Depth	300mm
Height	1040mm
Tube Size (upright)	25 x 1.6mm (mild steel)
Tube Size (racks)	30 x 1.6mm (mild steel)
Weight	7.8kg

Item	Part No.	Description
801573	TRI-WRA001	Woodrack Storage System



Ross Brand tools and accessories are a value for money product developed for the Australian market.

The Range Includes:

Air Tools

Compressors

Battery Chargers







Generators

Welders etc.



PART NO.	ITEM	DESCRIPTION	BARCODE	IMAGE
<b>AIR TOOLS</b>				
<b>ACCESSORIES FITTINGS &amp; HOSES</b>				
RAAIK14P	507075	<b>AIR ACCESSORY KIT 14 PIECE</b> This versatile air accessory & inflating kit includes: 1 x Nitto type female quick connector, 4 x Nitto type quick release male plugs, 1 x tyre inflation chuck, 2 x Nitto type quick release female plugs, 1 x tyre pressure gauge, 1 x double male union 1/4 to 1/4" BSP, 1 x double female union 1/4 to 1/4" BSP, 1 x safety nozzle, 1 x inflation needle & 1 x trigger operated blow gun.	9314539902706	
RAAIK20P	507076	<b>AIR ACCESSORY KIT 20 PIECE</b> This versatile air accessory & inflating kit includes: 1 x double female union 1/4 to 1/4" BSP, 1 x double male union 1/4 to 1/4" BSP, 2 x Nitto type quick release female plugs, 3 x Nitto type quick release male plugs, 2 x inflation needles, 1 x brass inflation nozzle, 1 x rubber inflation nozzle, 1 x roll PTFE thread tape, 1 x safety nozzle, 1 x needle adapter, 2 x Nitto type female quick connectors, 1 x trigger operated blow gun, 1 x 5m flexi-coil air hose with Nitto type quick release fittings, 1 x tyre inflation gauge & 1 x double sided tyre inflation chuck.	9314539902737	
RAFAF2P	507100	<b>AIR FITTING PACK 2 PIECE FEMALE (NITTO STYLE)</b> High-quality nitto style couplings offer superior operability and performance. 1/4" male & female threads for maximum versatility. Includes: 2 x female plugs.	9314539902751	
RAMAF2P	507113	<b>AIR FITTING PACK 2 PIECE MALE (NITTO STYLE)</b> High-quality nitto style couplings offer superior operability and performance. 1/4" male & female threads for maximum versatility. Includes 2 x male plugs.	9314539902744	
RAAF3P	507073	<b>AIR FITTING PACK 3 PIECE (NITTO STYLE)</b> High-quality nitto style couplings offer superior operability and performance. 1/4" male & female threads for maximum versatility. Includes: 1 x male plug, 1 x female plug and 1 x female coupler.	9314539902782	
RAAF5P	507074	<b>AIR FITTING PACK 5 PIECE (NITTO STYLE)</b> High-quality nitto style couplings offer superior operability and performance. 1/4" male & female threads for maximum versatility. Includes: 2 x male plugs, 2 x female plugs & 1 x female coupler.	9314539902799	



PART NO.	ITEM	DESCRIPTION	BARCODE	IMAGE
RAECG	510666	ENGINE CLEANING GUN	9314539903079	
RADBG	507099	<b>DUST BLOW GUN</b> Excellent balance & manoeuvrability for rapid cleansing of dust, swarf & water.	9314539902713	
RAMAFHT1/4	507114	<b>HOSE TAIL 1/4" 2 PACK</b> High-quality nitto style couplings offer superior operability and performance. 1/4" male & female threads for maximum versatility. Includes 2 x male plugs with 1/4" hose tail.	9314539902805	
RAMAFHT3/8	507115	<b>HOSE TAIL 3/8" 2 PACK</b> High-quality nitto style couplings offer superior operability and performance. 1/4" male & female threads for maximum versatility. Includes 2 x male plugs with 3/8" hose tail.	9314539902812	
RAINLUB	507109	<b>IN-LINE LUBRICATOR 1/4"</b> For adding air tool oil to the air flow. Use with Ross air tool & nailer oil for best results.	9314539902843	
RAIGWG	507108	<b>INFLATING GUN</b> General purpose inflating gun with rubber protected pressure gauge and highly flexible, hard wearing rubber hose.	9314539902720	

PART NO.	ITEM	DESCRIPTION	BARCODE	IMAGE
RAQC2P	507125	<b>QUICK COUPLER PACK 2 PIECE (NITTO STYLE)</b> High-quality nitto style couplings offer superior operability and performance. 1/4" male & female threads for maximum versatility. Includes 2 x male couplers	9314539902768	
RAQC2PF	507126	<b>QUICK CONNECTOR 2 PACK FEMALE</b> High-quality nitto style couplings offer superior operability and performance. 1/4" male & female threads for maximum versatility. Includes 2 x female couplers.	9314539902775	
RAQCHT1/4	507127	<b>QUICK CONNECT 1/4" HOSE TAIL 2 PACK</b> High-quality nitto style couplings offer superior operability and performance. 1/4" male & female threads for maximum versatility. Includes 2 x couplers with 1/4" hose tail	9314539902850	
RAQCHT3/8	507128	<b>QUICK CONNECT 3/8" HOSE TAIL 2 PACK</b> High-quality nitto style couplings offer superior operability and performance. 1/4" male & female threads for maximum versatility. 2 x couplers with 3/8" hose tail	9314539902867	
RAFILREG	507101	<b>REGULATING FILTER 1/4"</b> For regulating the air flow and removing moisture. 1/4" BSP female inlet & outlet enable mounting on compressors or in the air line.	9314539902836	

PART NO.	ITEM	DESCRIPTION	BARCODE	IMAGE
RA1410C	510911	AIR HOSE 1/4"x10M COILED (NITTO STYLE)	9314539903451	
RA3805	507052	AIR HOSE 5M (NITTO STYLE)		
RA3810	510912	AIR HOSE 3/8" x 10M (NITTO STYLE)	9314539903468	
RA3815	507053	AIR HOSE 3/8" X 15M 1/4" (NITTO STYLE) 15 Metre Air Hose 9.5mm 3/8", High Quality Nitto Style fittings Hi Vis for safety, Max. 300 PSI	9314539902065	
RA3820	510913	AIR HOSE 3/8" x 20M (NITTO STYLE) 20 Metre Air Hose 9.5mm 3/8", High Quality, 300 PSI Nitto Style fittings, Hi Vis for safety	931453990347	
RA3830	507056	AIR HOSE 3/8" X 30M 1/4" (NITTO STYLE)	9314539902072	
RA3815R	507054	RETRACTABLE AIR HOSE REEL 3/8" X 15M 1/4" BSP 15 Metre Retractable Air Hose Reel 9.5mm 3/8", High Quality, 300 PSI Nitto Style fittings, Hi Vis for safety	9314539902089	
RA3820R	507055	RETRACTABLE AIR HOSE REEL 3/8" X 20M 1/4" BSP 20 Metre Retractable Air Hose Reel 9.5mm 3/8", High Quality, 300 PSI Nitto Style fittings, Hi Vis for safety	9314539902171	
RAHV-215	507107	AIR HOSE ON REEL 3/8" X 15M BSP FITTINGS 15 Metre Air Hose Reel 9.5mm 3/8", High Quality, 300 PSI Nitto Style fittings, Hi Vis for safety	9314539902164	
<b>BODY SAW</b>				
RA909	507067	AIR BODY SAW STANDARD DUTY Reciprocating Air Saw. Lightweight alloy body with rubber grip. Cuts a wide range of materials. Ideal for panel shops. Trim and shape light metal plate, sheet metal and plastics. 9000 strokes per minute cutting speed.	9314539903598	
<b>CUT OFF TOOL</b>				
RA813A	507064	CUT-OFF TOOL 3" STANDARD DUTY No-Load Speed 20,000rpm Air Consumption 113L/min (4.0cfm), Cutting Wheel 76.2mm (3"), Air Exhaust Rear Weight 760g (1.67lb), Working Air Pressure 6.2bar (90psi) Air inlet 1/4' bsp , Rugged, lightweight alloy body with non-slip finish Compact and easy to handle, Adjustable Metal Safety Guard	9314539901938	
RAC823	507094	CUT-OFF TOOL 3" HEAVY DUTY DUAL COMP 75mm Air Cut off Tool. Strong lightweight composite body with comfort grip. Adjustable exhaust position. 4 position throttle control. 10 position adjustable metal safety guard. Quickly and efficiently cut off mufflers, tail pipes and car panels, nuts & bolts, etc. lever throttle for accurate speed control and feathering. 18000 rpm no load speed. Average air consumption 86 litres per minute. 205mm in length. 90 psi.	9314539903512	

PART NO.	ITEM	DESCRIPTION	BARCODE	IMAGE
<b>DIE GRINDER</b>				
RA811A	507062	<b>MINI AIR DIE GRINDER STANDARD DUTY</b> No-Load Speed 25,000rpm, Air Consumption 80L/min (2.8cfm) Collets 6.0mm and 1/4" Included, Weight 370g (.8lb) Working Air Pressure 6.2bar (90psi) Lever throttle, for accurate speed control and feathering Rear exhaust directs air away from work piece Rugged, lightweight alloy body with non slip finish	9314539901983	
RAC861	507097	<b>MINI AIR DIE GRINDER HEAVY DUTY DUAL COMP</b> Mini Air Die grinder. Lever throttle for accurate speed control and feathering. Rear exhaust directs air away from work piece. Strong lightweight composite body with comfort grip. Ideal for most applications where grinding, deburring, sanding or polishing is required. Compact design is perfect for working in tight spots. 6mm collet, 1/4" collet. No load speed 25,000 rpm. Consume 85 litres per minute of air. Only 121mm long. Requires 90 psi air pressure.	9314539903529	
RA812A	507063	<b>AIR DIE GRINDER STANDARD DUTY</b> No-Load Speed 22,000rpm, Air Consumption 114L/min (4.0cfm), Collets 6.0mm and 1/4" included, Weight 570g (1.25lb) Working Air Pressure 6.2bar (90psi), Air Inlet 1/4" BSP, Lever throttle for accurate speed, control and feathering Rear exhaust directs air away from work piece Rugged, lightweight alloy body with non slip finish	9314539901969	
RAC851	507095	<b>AIR DIE GRINDER HEAVY DUTY DUAL COMP</b> Air Die grinder. 4 position lever throttle for accurate speed control and feathering. Rear exhaust directs air away from work piece. Strong lightweight composite body with comfort grip. Ideal for most applications where grinding, deburring, sanding or polishing is required. Compact design is perfect for working in tight spots. 6mm collet, 1/4" collet. No load speed 25,000 rpm. Consume 85 litres per minute of air. only 121mm long. requires 90 psi air pressure.	9314539903536	
RA816	507065	<b>AIR ANGLE GRINDER STANDARD DUTY</b> Lever throttle for accurate speed control and feathering. Rear exhaust directs air away from the work piece. Rugged, lightweight alloy body with non-slip finish. Ideal for most applications where grinding, deburring, sanding or polishing is required. 6mm collet, 1/4" collet. No load speed 20,000 rpm. Consumes 112 litres per minute of air. Requires 90 psi air pressure.	9314539903604	
RAC856	507096	<b>AIR ANGLE GRINDER HEAVY DUTY DUAL COMP</b> 4 position lever throttle for accurate speed control and feathering. Rear exhaust directs air away from work piece. Strong lightweight composite body with comfort grip. Ideal for most applications where grinding, deburring, sanding or polishing is required. 6mm collet, 1/4" collet. No load speed 20,000 rpm. Consumes 85 litres per minute of air. Requires 90 psi air pressure.	9314539903543	
RA818	507066	<b>AIR ANGLE GRINDER 4" STANDARD DUTY</b> 100mm Air Angle Grinder. Rugged aluminium body, throttle safety lever, sturdy metal safety guard. 11,000 rpm no load speed. 108 litres per minute average air consumption. Front air exhaust, operating pressure 90 psi.	9314539903611	

PART NO.	ITEM	DESCRIPTION	BARCODE	IMAGE
<b>DRILL</b>				
RA650	507058	<b>KEYLESS REVERSIBLE AIR DRILL 3/8" STANDARD DUTY</b> 3/8" Air Drill , No-Load Speed 1,800rpm Air Consumption 108L/min(3.8cfm), Chuck Capacity 3/8" (key less) Weight 1.1kg (2.42lb), Working Air Pressure 6.2bar (90psi) Air Inlet 1/4" BSP , 10mm (3.8") keyless chuck Rugged, lightweight alloy body with non-slip finish Variable speed trigger for ultimate control Convenient one-hand operation with side mounted forward/reverse lever, Fully hardened planetary gearing for long life		
RAC681	507088	<b>AIR DRILL 3/8" HEAVY DUTY DUAL COMP</b> Air drill, 10mm keyless chuck. Strong, lightweight composite body with comfort grip. Variable speed for ultimate control. Convenient one-handed operation with side mounted forward and reverse lever. Fully hardened planetary gears for long life. Ideal for all general drilling, honing and hole sawing work in the workshop.	9314539903550	
<b>HAMMER</b>				
RA502	507057	<b>AIR HAMMER 150MM STANDARD DUTY</b> Blows Per Minute 4,500bpm, Air Consumption 65L/min (2.3cfm), Chisel 10.2mm (0.401in") Shank Type Round, Air Exhaust Front , Barrel Stroke 41mm (1-5/8")	9314539901976	
RACS4P	507098	<b>CHISEL SET 4 PIECE 120MM</b> Replacement air chisel set with 4 different chisel for a variety of applications. For use with air hammer model RA502	9314539901884	
RARS2P	507129	<b>CHISEL RETAINER SPRING 2 PACK</b> Replacement spring pack (2 pce) for the replacement of broken or worn air hammer springs. To replace, simply unscrew the spring while not in operation and replace by screwing the replacement spring.	9314539901891	
<b>IMPACT KIT</b>				
RAK17	507110	<b>AIR IMPACT WRENCH KIT 1/2" 17 PIECES</b> 17 piece air tool kit. 230 ft/lb impact wrench, 10 metric chrome vanadium impact socket in a sturdy blow mould case. General purpose impact wrench kit ideal for home workshop and automotive applications. Kit contains 1/2" impact wrench, 10 x 1/2" drive chrome vanadium sockets - sizes 10, 12, 13, 14, 15, 17, 18, 19, 21, 22. 125mm extension bar, oil pot, nitto style plug, in line oiler, 4mm hex key, blow mould case.	9314539903628	
<b>IMPACT WRENCH</b>				
RAC715	507089	<b>AIR IMPACT 3/8 DR WRENCH H/DUTY DUAL COMP</b> High torque capability allows fast removal of stubborn bolts and replacement of most automotive, farm and household fasteners. Powerful twin hammer mechanism for maximum output and smoothness. Strong lightweight composite body with comfort grip. High torque twin hammer mechanism. Three position power regulator prevents over-torque. Includes: 3/8" High Torque Twin Hammer Impact Wrench, Nitto style male quick release fitting. No load speed 8,000rpm. Average Air Consumption 85 L/Min. Torque 407Nm (300ft/lbs). Length 170mm. Weight 1.22kg. Air Pressure 6.2 bar (90psi). Air Inlet 1/4" BSP.	9314539903574	
RA702A	507059	<b>AIR IMPACT 1/2 DR WRENCH STD DUTY</b> 312NM 1/2" dr, No-Load Speed 7,000rpm Air Consumption 114L/min (4.0cfm) , Max Torque 312Nm (230ft-lb), Speed Settings 4, Clutch Type Rocking Dog, Weight 2.18kg (4.8lb) Working Air Pressure 6.2bar (90psi), Air Inlet 1/4" BSP Compact ergonomic design for increased comfort Lightweight alloy body with non-slip finish Four position power regulator to prevent over-torque One-handed push button selects forward and reverse	9314539901914	







**ROSS**





PART NO.	ITEM	DESCRIPTION	BARCODE	IMAGE
RA705A	507061	<b>AIR IMPACT 1/2 DR WRENCH 407NM STD DUTY</b> 407NM 1/2" dr, Impact Wrench, HI-TORQUE AIR IMPACT WRENCH, No-Load Speed 7,000rpm, Air Consumption 93L/min (3.3cfm) Max Torque 407Nm (300ft-lb), Clutch Type Twin Hammer Weight 2.2kg (4.84lb), Working Air Pressure 6.2bar (90psi) Air Inlet 1/4" BSP, Speed Settings 3 Forward - 1 Reverse • High torque twin hammer mechanism • Non-slip finish for comfort and stability • Three position power regulator prevents over-torque	9314539901921	
RAC725	507090	<b>AIR IMPACT 1/2 DR WRENCH H/DUTY DUAL COMP</b> High torque capability allows fast removal of stubborn bolts and replacement of most automotive, farm and household fasteners. Powerful twin hammer mechanism for maximum output and smoothness. Strong lightweight composite body with comfort grip. High torque twin hammer mechanism. Three position power regulator prevents over-torque. Includes: 1/2" High Torque Twin Hammer Impact Wrench, Nitto style male quick release fitting. No load speed 7,000rpm. Average Air Consumption 115 L/Min. Torque 746Nm (550ft/lbs). Length 180mm. Weight 2.1kg. Air Pressure 6.2 bar (90psi). Air Inlet 1/4" BSP.	9314539903567	
RAC735	507093	<b>AIR IMPACT 3/4 DR WRENCH 1356NM</b> 1000 FT-LB High Torque Twin Hammer Mechanism Strong Lightweight composite body with comfort grip Three position power regulator prevents over-torque High torque capability allows fast removal of stubborn bolts and replacement of most automotive, farm and household fasteners. Powerful twin hammer mechanism for maximum output and smoothness Includes: 3/4" High Torque Twin Hammer Impact Wrench, Nitto Style Male Fitting, Manual, No-Load Speed - 4,000 rpm Average Air Consumption - 153L/min Torque - 1356 Nm (1,000 ft-lb), Length - 240 mm Weight - 3.9kg, Air Pressure - 6.2 bar (90 psi) Air Inlet - 3/8" BSP	9314539903499	
<b>NAILER OIL</b>				
RAOT500	507124	<b>AIR TOOL &amp; NAILER OIL 500ML</b> Ross airtool & gun oil. Suits all air tools and nail guns. Maximizes performance and life of pneumatic tools. The primary cause of repair for pneumatic tools is improper air line lubrication. Correct oil usage maximizes the performance and life of your pneumatic tools. The primary cause of repair for pneumatic tools is improper airline lubrication. Pneumatic tools require lubricated air at the right compression. Failure to provide these basic needs for your tools can result in reduced performance (speed, torque) and shorter motor life.	9314539902881	
<b>POLISHER</b>				
RA332	507051	<b>AIR POLISHER 3" 2200RPM</b> 75mm air polisher is ideal for use in tight work areas. It has a rugged lightweight alloy body with non slip finish. Its low speed operation is for polishing, waxing and sanding applications. Included is the air sander / polisher, 70mm disk, 3 pads, nitto style plug, 11mm wrench and instruction manual.	9314539901877	

PART NO.	ITEM	DESCRIPTION	BARCODE	IMAGE
<b>RATCHET</b>				
RA703B	507060	<b>AIR RATCHET 3/8DR STANDARD DUTY</b> No-Load Speed 160rpm, Air Consumption 85L/min (3.0cfm) Max Torque 68Nm (50ft-lb), Weight 1.19kg (2.62lb) Working Air Pressure 6.2bar (90psi) Air Inlet 1/4" BSP • Lightweight alloy body with non-slip finish • Heat-treated components and planetary gears for increased tool life • Ball socket nut retainer provides fast and easy socket replacement	9314539901907	
RAC733	507091	<b>AIR RATCHET 3/8DR HEAVY DUTY DUAL COMP</b> Strong lightweight composite body with comfort grip. Adjustable exhaust position. 4 Position throttle control. Heat treated components and planetary gears for increased tool life. Ball socket nut retainer provides fast and easy socket replacement. Ideal for radiator, sparkplug, fuel pump and air conditioner unit removal and replacement. Maximum torque - 102Nm. 115 litres per minute air consumption. 90 psi air pressure. 265mm overall length.	9314539903581	
RAC734	507092	<b>AIR RATCHET 1/2DR HEAVY DUTY DUAL COMP</b> Strong lightweight composite body with comfort grip. Adjustable exhaust position. 4 Position throttle control. Heat treated components and planetary gears for increased tool life. Ball socket nut retainer provides fast and easy socket replacement. Ideal for radiator, sparkplug, fuel pump and air conditioner unit removal and replacement. Maximum torque - 102Nm. 115 litres per minute air consumption. 90 psi air pressure. 265mm overall length.	9314539903482	
<b>SANDER</b>				
RA312	507050	AIR SANDER DUAL ACTION 6" STANDARD DUTY	9314539901945	
RAC380	507087	AIR SANDER HEAVY DUTY DUAL COMP	9314539903505	
<b>NAILERS</b>				
RABNS	511015	<b>BRAD NAILER STAPLER 50MM 18 GAUGE</b> Soft Grip Handle, 2 in 1 Magazine - Holds Brad Nails or Staples Adjustable Depth of Drive, Adjustable Exhaust Lightweight Die Cast Body Harnessing the power and safety of compressed air. This Ross nailer stapler is suitable for picture frames, upholstery, cabinet and woodworking projects. Quality components and high-tolerance manufacturing means this tool will maintain a high level of performance for longer and will not let you down when you need it most. Nail capacity (Qty): 100 pcs Nail size: 15-50 mm (5/8" - to 2") Staples size: 15-40mm, (5/8" to 1-5/8"), 5.7mm Crown Gauge: 18 - for both nails and staples. Recommended operating pressure: 60-100 PSI (4-7 bar) Maximum pressure: 8.3 bar (120 PSI) Air inlet: Nitto style connector Dimensions: 55 x 245 x 250 mm Weight: 1.5 kg	9314539903086	

PART NO.	ITEM	DESCRIPTION	BARCODE	IMAGE
RAF90	511016	<b>FRAMING NAILER 34DEG 90MM</b> Soft Grip Handle, Adjustable Depth of Drive Adjustable Exhaust, No Mark Bumper Lightweight Die Cast Body A well balanced nail gun with 34 degree angled magazine allows you to access all areas for fast completion of framing and other construction jobs. This Ross nail gun comes with quality components and is manufactured to high tolerances. This tool will maintain a high level of performance for longer and will not let you down when you need it most Nail capacity (Qty): 80 pcs Nail size: 50 mm (2") to 90mm (3-1/2"), 34 deg, Clipped head framing nails Recommended operating pressure: 80-110 PSI (5.5-7.5 bar) Maximum pressure: 8.3 bar (120 PSI) Air inlet: Nitto style connector Dimensions: 120 x 378 x 500 mm Weight: 4.0 kg	9314539903093	
RACSG	511017	<b>CROWN STAPLER 18 GAUGE 38MM</b> Soft Grip Handle, Front air exhaust Lightweight Die Cast Body Harnessing the power and safety of compressed air. This Ross crown stapler is suitable for picture frames, upholstery, cabinet and woodworking projects. Quality components and high-tolerance manufacturing means this tool will maintain a high level of performance for longer and will not let you down when you need it most Staple capacity (Qty): 100 pcs Staple size: 16mm (5/8") to 40mm (1-1/4"), 5.7mm Crown, 18 Gauge. Recommended operating pressure: 4-7 bar (60 -100 PSI) Maximum pressure: 8.3 bar (120 PSI) Air inlet: Nitto style connector Dimensions: 55 x 235 x 255mm Weight: 1.45 kg	9314539903109	
RANCN65	507120	<b>15 DEGREE COIL NAILER 65MM</b> 25-65mm, Lightweight alloy body with comfort grip for comfort and control gives a superb power to weight ratio Coil style magazine holds up to 300 collated nails	9314539902034	
RAFNG	511018	<b>FINISHING NAILER 16 GAUGE 50MM</b> Soft Grip Handle, Quick clear nose, Adjustable Exhaust No Mark Tip, Lightweight Die Cast Body Harnessing the power and safety of compressed air, this Ross Finishing Nailer allows you to finish your window, door, cabinet and woodworking projects efficiently and effectively. Quality components and high-tolerance manufacturing means this tool will maintain a high level of performance for longer and will not let you down when you need it most Nail capacity (Qty): 90 pcs Nail size: 20mm (3/4") to 50mm (2") 16 Gauge finishing nails Recommended operating pressure: 4-7 bar (60 -100 PSI) Maximum pressure: 8.3 bar (120 PSI) Air inlet: Nitto style connector Dimensions: 80 x 280 x 303mm Weight: 2.3 kg		



PART NO.	ITEM	DESCRIPTION	BARCODE	IMAGE
RATN64	511019	<b>T NAILER 16 GAUGE 64MM</b> Soft Grip Handle, Quick clear nose, Adjustable Exhaust Adjustable depth drive, Lightweight Die Cast Body Harnessing the power and safety of compressed air, this Ross Finishing Nailer allows you to finish your window, door, cabinet and woodworking projects efficiently and effectively. Quality components and high-tolerance manufacturing means this tool will maintain a high level of performance for longer and will not let you down when you need it most. Also features a tool free depth control for accurate setting and a non marking nose. Nail capacity (Qty): 100 pcs Nail size: 32mm (1-1/4") to 64mm (2-1/3"), 16 Gauge Finishing Nails Recommended operating pressure: 4-7 bar (60 -100 PSI) Maximum pressure: 8.3 bar (120 PSI) Air inlet: Nitto style connector Dimensions: 75 x 270 x 320mm Weight: 1.88 kg		
<b>SPRAY GUN</b>				
RAGFGP	507104	<b>SPRAY GUN GRAVITY FEED GENERAL PURPOSE</b> General purpose gravity feed spray gun. 1.5mm standard nozzle. Operating pressure 3-4 bar. Pattern width 180 - 250mm. Air consumption 119-201 litres per minute. Paint capacity 400cc. Highly engineered air cap set, nozzle and needle for atomisation. Durable nozzles & needle offer stable performance for long terms.	9314539902133	
RAGFTU	507105	<b>SPRAY GUN GRAVITY FEED TOUCH UP</b> Professional touch up gravity feed spray gun has a 0.8mm standard nozzle with an operating pressure of 3-4 bar. Pattern width is 110-160mm and air consumption of 99-169 litres per minute. Paint capacity is 150cc. HVLP spray guns for high quality finish with even flow and minimal over spray. Designed to provide equal atomisation and particle size for all kinds of surface painting.	9314539902126	
RASFGP	507167	<b>SPRAY GUN SUCTION FEED GENERAL PURPOSE</b> General purpose spray gun, suction feed with a standard 1.5mm nozzle. Operating pressure 3-4.0 bar. Pattern width 180-250mm. Air consumption 119-201 litre per minute. 750cc paint capacity. Professional style, body-shop type spray gun suitable for use with smaller compressors. High efficiency transfer from medium to high viscosity materials in a wide variety of applications.	9314539902140	
RASFPQ	507168	<b>SPRAY GUN SUCTION FEED PROFESSIONAL QUALITY</b> Professional finishing spray gun, suction feed with a standard 1.8mm nozzle. Operating pressure 3-4.0 bar. Pattern width 180-230mm. Air consumption 170-230 litre per minute. 1000cc paint capacity. High efficiency	9314539902157	
RAGFWS	507106	<b>SPRAY GUN SET GRAVITY FEED WITH STAND</b> Professional Spray Gun Kit. The Top coat gravity feed spray gun has a 1.4mm standard nozzle HVLP, operating pressure between 1-3 bar. The pattern width is 180-250mm. Air consumption is 200-250 litres per minute. Kit contains Spray Gun, Gun stand, On gun regulator, filter, spanner, socket spanner and brush.	9314539902096	





PART NO.	ITEM	DESCRIPTION	BARCODE	IMAGE
RAGF3K	507102	<b>SPRAY GUN SET GRAVITY FEED 3 PIECES</b> 3 pce Professional Spray Gun Kit. The Top coat gravity feed spray gun has a 1.4mm standard nozzle HVLP, operating pressure between 1-3 bar. The pattern width is 180-250mm. Air consumption is 200-250 litres per minute. The primer spray gun is also gravity feed with a 1.7mm standard nozzle HVLP, operates between 1-3 bar. The pattern width is 180-250mm. Air consumption is 200-250 litres per minute. Kit contains Top coat spray gun, primer coat spray gun, On gun regulator, filter, spanner, socket spanner and brush.	9314539902119	
RAGF4K	507103	<b>SPRAY GUN SET GRAVITY FEED 4 PIECES</b> 4 pce Professional Spray Gun Kit. The Top coat gravity feed spray gun has a 1.4mm standard nozzle HVLP, operating pressure between 1-3 bar. The pattern width is 180-250mm. Air consumption is 200-250 litres per minute, paint capacity is 1000cc. The primer spray gun is also gravity feed with a 1.7mm standard nozzle HVLP, operates between 1-3 bar. The pattern width is 180-250mm. Air consumption is 200-250 litres per minute, paint capacity is 1000cc. The touch up spray gun has a 0.8mm standard nozzle with an operating pressure of 3-4 bar. Pattern width is 110-160mm and air consumption of 99-169 litres per minute. Paint capacity is 150cc. Kit contains Top coat spray gun, primer coat spray gun, touch up spray gun, on gun regulator, filter, spanner, socket spanner and brush.	9314539902102	
<b>TOOL KITS</b>				
RAATK5P	507078	<b>AIR TOOL STARTER KIT 5 PIECES</b>	9314539902829	
RAK34	507111	<b>AIR TOOL KIT 34 PIECES</b> General purpose air tool kit ideal for home workshop and automotive applications. Kit contains 1/2" drive impact wrench, 3/8" drive ratchet wrench, 150mm air hammer, 1/4" die grinder in blow mould case with accessories. 10 x 1/2" drive chrome vanadium sockets - sizes 10, 12, 13, 14, 15, 17, 18, 19, 21, 22. 125mm extension bar, 3/8-1/2 adaptor, 3 x 125mm round chisels, 3 x mounted point grinding stones 5 x nitto style plugs, nitto style quick coupler, oil pot, nitto style plug, in line oiler, 4mm hex key, blow mould case.	9314539903635	
RAK50	507112	<b>AIR TOOL KIT 50 PIECES</b> General purpose air tool kit ideal for home workshop and automotive applications. Kit contains 1/2" drive impact wrench, 3/8" drive ratchet wrench, 150mm air hammer in blow mould case with accessories. 10 x 1/2" drive chrome vanadium sockets - sizes 10, 12, 13, 14, 15, 17, 18, 19, 21, 22. 125mm extension bar, 3/8-1/2 adaptor, 3 x 125mm round chisels, 5 x nitto style plugs, nitto style quick coupler, swivel hose connector, air gun, 2 x sports needle plus adaptor, ball foot air chuck, tapered nozzle, high pressure nozzle, dual foot tyre gauge, screwdriver bit holder, 6 x 1/4 hex bits, oil pot, nitto style plug, in line oiler, 4mm hex key, blow mould case.	9314539903642	







PART NO.	ITEM	DESCRIPTION	BARCODE	IMAGE
<b>BATTERY CHARGERS</b>				
<b>CHARGE &amp; JUMP START BENCH MODEL</b>				
RBC220	507177	<b>BATTERY CHARGER 20A CHARGE/120A START</b> 20 amp charge - 120amp start Suit 12&24 volt batteries 20-400Ah batteries	9314539902188	
RBC400	507180	<b>BATTERY CHARGER 40A CHARGE/180A START</b> 40 amp charge - 180amp start Suit 12&24 volt batteries 20-400Ah batteries	9314539902195	
<b>CHARGE &amp; JUMP START WHEEL MOUNT</b>				
RBC320	507178	<b>BATTERY CHARGER 30A CHARGE/180A START</b> 30 amp charge - 180amp start Suit 12&24 volt batteries 20-400Ah batteries	9314539902201	
RBC520	507181	<b>BATTERY CHARGER 50A CHARGE/360A START</b> 50 amp charge - 360amp start Suit 12&24 volt batteries 20-800Ah batteries	9314539902218	
RBC620	507183	<b>BATTERY CHARGER 60A CHARGE/540A START</b> 60 amp charge - 540amp start Suit 12&24 volt batteries 20-1000Ah batteries	9314539902225	
<b>CHAINSAWS</b>				
RGCS38CC	507211	<b>CHAINSAW PETROL 38CC 16" OREGON BAR</b> Petrol Chainsaw 38CC 16" Oregon Bar Air-Cooled Two Stroke Engine Automatic Chain oiler, Easy Start technology Auto choke release, Safety Chain brake Oregon bar and chain, Anti Vibration system	9314539901631	
RGCS45CC	507213	<b>CHAINSAW PETROL 45CC 18" OREGON BAR</b> Petrol Chainsaw 45CC 18" Oregon Bar, Air-Cooled Two Stroke Engine Automatic Chain oiler, Easy Start technology, Auto choke release, Safety Chain brake, Oregon bar and chain, Anti Vibration system	9314539901648	

PART NO.	ITEM	DESCRIPTION	BARCODE	IMAGE
<b>COMPRESSOR</b>				
<b>DIRECT DRIVE</b>				
RAAC1.5/15	507068	<b>COMPRESSOR DIRECT DRIVE 1.5HP 15L TWIN STACK</b> High pressure - ideal for nailing applications Oil free - low maintenance, High pressure is ideal for nailing applications such as home fix outs. • Also ideal for tyre inflation. • Oil free compressor pump provides low maintenance and ease of transport. • Compact design with collapsible handle for ease of handling and storage. • Other features include power cord, hose and nail gun hooks, over size regulator and gauges, accessory storage compartment, rubberised wheel and anti-vibration foot pads. Input Voltage - 240 V ~ 50 Hz Power - 1.5 Hp Tank Capacity - 15 Litres Maximum Pressure - 10.7 bar (155 psi) Free Air Delivery - 76 L/Min Air Outlets - Air Outlets 2 Air Fittings - Nitto style Weight - 20.5 kg	9314539903000	
RAAC2/24	507070	<b>COMPRESSOR DIRECT DRIVE 2HP 24LTR</b> Free Air Delivery 115 L/Min, Regulator with Twin Outlet Cast Iron Cylinder Barrel for Longer Life, Suitable for use with 10A-240V, Standard Domestic Power Supply Manufactured to Australian Standards	9314539901761	
RAAC2.5/36	507069	<b>COMPRESSOR DIRECT DRIVE 2.5HP 36LTR</b> 2.5HP Motor 36 Litre Tank Free Air Delivery 134 Litres/Min Cast iron pump for longer life Manufactured to Australian Standards Suitable for use with (10A 240V) Standard domestic power supply	9314539901778	
RAV2.75/36	507170	<b>COMPRESSOR DIRECT DRIVE 2.75HP V-TWIN 36L</b> Free Air Delivery 205L/Min Regulator with Twin Outlet Cast Iron Cylinder Barrel for Longer Life Suitable for use with 10A-240V Standard Domestic Power Supply Manufactured to Australian Standards	9314539901754	
RAV2.75/50	507171	<b>COMPRESSOR DIRECT DRIVE 2.75HP V-TWIN 50L</b> Free Air Delivery 205L/Min, Regulator with Twin Outlet Cast Iron Cylinder Barrel for Longer Life Suitable for use with 10A-240V Standard Domestic Power Supply Manufactured to Australian Standards	9314539901747	

PART NO.	ITEM	DESCRIPTION	BARCODE	IMAGE
<b>BELT DRIVE</b>				
RAV2051/50/2.5	507173	<b>BELT DRIVE COMPRESSOR V-TWIN 2.5HP 50L</b> Free air delivery 162 litres/min, Cast iron pump for longer life.	9314539901662	
RAV2065/50/3	507175	<b>BELT DRIVE COMPRESSOR V-TWIN 3HP 50L</b> 220 Litres/Min giving a more than adequate output for most workshop requirements	9314539901686	
RAV2051/100/2.5	507172	<b>BELT DRIVE COMPRESSOR V-TWIN 2.5HP 100L</b> Free air delivery 162 litres/min Cast iron pump for longer life.	9314539901679	
RAV2065/100/3	507174	<b>BELT DRIVE COMPRESSOR V-TWIN 3HP 100L</b> 220 Litres/Min giving a more than adequate output for most workshop requirements	9314539901693	
RABD255/50/2.5	507084	<b>BELT DRIVE COMPRESSOR 2.5HP 50L</b> 2.5HP - 50lt Belt Drive Compressor Motor 2.5HP, Tank Size 50L Free Air Delivery 167L/Min Max Pressure 9 bar (130PSI)	9314539901709	
RABD265/50/3	507086	<b>BELT DRIVE COMPRESSOR 3HP 50L</b> 3HP - 50lt Belt Drive Compressor Motor 3HP, Tank Size 50L Free Air Delivery 242L/Min Max Pressure 9 bar (130PSI)	9314539901723	
RABD255/100/2.5	507083	<b>BELT DRIVE COMPRESSOR 2.5HP 100L</b> 2.5HP - 50lt Belt Drive Compressor Motor 2.5HP, Tank Size 100L Free Air Delivery 167L/Min Max Pressure 9 bar (130 PSI)	9314539901716	
RABD265/100/3	507085	<b>BELT DRIVE COMPRESSOR 3HP 100L</b> 3HP - 100lt Belt Drive Compressor Motor 3HP, Tank Size 100L Free Air Delivery 242L/Min Max Pressure 9 bar (130PSI)	9314539901730	

PART NO.	ITEM	DESCRIPTION	BARCODE	IMAGE
RAB2800/50/2.5	507080	<b>BELT DRIVE COMPRESSOR TECH 2.5HP 50L</b> Motor 2.5 HP , Tank Size 50 L, Pump Speed 1,250 RPM Free Air Delivery 175 L/Min Input 240 V, Fuse Rating 10 AMP Cylinders 2, Stages 1, Max Pressure 10 Bar (145 psi) Packed Dimensions H:67 cm x W:38 cm x L:87 cm weight 68kg	9314539903048	
RAB3800/50/3	507082	<b>BELT DRIVE COMPRESSOR TECH 3HP 50L</b> Motor 3 HP, Tank Size 50 L Pump Speed 1,100 RPM Free Air Delivery 270 L/Min Input 240 V, Fuse Rating 15 AMP Cylinders 2, Stages 1 Max Pressure 10 Bar (145 psi) Packed Dimensions H:73 cm x W:38 cm x L:87cm weight 76kg	9314539903024	
RAB2800/100/2.5	507079	<b>BELT DRIVE COMPRESSOR TECH 2.5HP 100L</b> Motor 2.5 HP, Tank Size 100 L Pump Speed 1,250 RPM Free Air Delivery 175 L/Min, Input 240 V Fuse Rating 10 AMP Cylinders 2, Stages 1 Max Pressure 10 Bar (145 psi) Packed Dimensions H:67 cm x W:45 cm x L 110cm weight 95kg	9314539903055	
RAB3800/100/3	507081	<b>BELT DRIVE COMPRESSOR TECH 3HP 100L</b> Motor 3 HP, Tank Size 100 L Pump Speed 1,100 RPM Free Air Delivery 270 L/Min Input 240 V, Fuse Rating 15 AMP Cylinders 2, Stages 1 Max Pressure 10 Bar (145 psi) Packed Dimensions H:88 cm x W:45 cm x L 110cm Weight 102kg	9314539903031	
<b>PETROL</b>				
RAAC6.5/50P	507071	<b>PETROL COMPRESSOR 6.5HP/50L</b> 6.5HP petrol engine, 50 litre tank Free Air Delivery 295 L/Min more air, more versatile. Pneumatic idle device - saves fuel, wear & tear. Semi inflatable wheels	9314539901785	
<b>COMPRESSOR OIL</b>				
RAOC1000	507123	<b>AIR COMPRESSOR OIL 1 LITRE</b> Ross compressor oil will provide excellent wear protection for all compressors. Suitable for piston (reciprocating) type compressors (including crankcase and cylinders). Rotary screw compressors where ISO 150 is required. Rotary Vane compressors (Hydrovane) Superior anti-wear and corrosion protection enhances compressor life and performance whilst outstanding oxidation & thermal stability controls sludge and deposit forming. Mineral Oil > 99% ISO 150 / SAE40 Size 1 litre.	9314539902874	



PART NO.	ITEM	DESCRIPTION	BARCODE	IMAGE
<b>GARDEN TOOLS</b>				
<b>BATTERIES - SPARES</b>				
RG-18B	507207	GARDEN SPARE BATTERY TO SUIT 18 VOLT LI-ION		
RG-21C	507208	GARDEN SPARE BATTERY CHARGER FOR 18 VOLT LI-ION		
<b>BLOWER</b>				
RGPB	507219	GARDEN BLOWER PETROL	9314539903406	
RGB18	507209	<b>CORDLESS BLOWER 18V LI-ION</b> powerful 18 volt motor, blower speed 160Km/h 1 hour fast charger, 18 Volt - 1.3Ah lithium-ion battery • Lightweight Design for Ease of use and storage • Soft grip rear handle for greater comfort Charger Input Voltage 220-240V ~ 50Hz Charge time 1 Hour Battery 18V - 1.3Ah Li-ion Blower Velocity 160Km/h Weight 1.2Kg	9314539903734	
<b>HEDGE TRIMMER</b>				
RGHT18	507214	<b>CORDLESS HEDGE TRIMMER 18V LI-ION</b> powerful 18 volt motor 1 hour fast charger Extra long 51cm cutting blade Dual Cutting Action reduces vibration and user fatigue • Makes light work of trimming hedges and shrubs. • Soft grip rear handle for added comfort Charge Input Voltage 220-240V~ 50Hz Battery 18V - 1.3Ah Li-ion Cutting movements 2800min-1 Max Cutting Diameter 14mm Unit weight 2.2 Kg	9314539903710	
RGPHT26	507223	GARDEN HEDGE TRIMMER PETROL	9314539903680	
<b>LINE TRIMMER</b>				
RGLT18	507216	<b>CORDLESS LINE TRIMMER 18V LI-ION</b> 18 VOLT LI-ION LINE TRIMMER powerful 18 Volt motor 1 hour fast charger, Telescopic handle, Automatic spool Adjustable auxiliary handle for improved comfort and control. • Height and angle adjust to suit all types of users and trimming. • 18 Volt - 1.3Ah lithium-ion battery Charger Rated voltage: 220-240V ~ 50Hz Charge time 1 Hour, Battery 18V - 1.3Ah Li-ion No load speed: 7500/min-1, Cutting width 250mm Line diameter 1.2 mm, Weight 2.0 kg	9314539903727	
RGLT530/S	507218	SPOOL TO SUIT RGLT530 (2 PIECE)	9314539903697	
RGPLT26	507224	<b>PETROL LINE TRIMMER 26CC</b> Easy start, Dual line bump feed Bent split shaft, Adjustable d handle Easy start system - For hassle free starting every time • Dual line bump feed - For fast and easy line extension • Curved split shaft - Great for hard to reach corners of the garden • Adjustable d handle - For added user comfort and superior control • Safety switch - For Convenience Includes: Spark plug spanner, Spool wrench, Fuel mixing container, Support strap, Instruction manual Engine - 2 Stroke Air Cooled, Displacement - 26cc Cutting Diameter - 380mm, Fuel/Oil Mix Ratio - 40:1 Fuel Capacity - 500ml, Head Type - Nylon	9314539901860	

PART NO.	ITEM	DESCRIPTION	BARCODE	IMAGE
<b>POST HOLE DIGGER</b>				
RPPHA150MM	507474	<b>POST HOLE DIGGER 49CC 150MM</b> With this high-powered earth auger digging holes is a breeze. Fully tested to suit Australian conditions. Lightweight, easy to use, single person operation. Ideal applications include: fence posts, retaining walls, tree-planting, plumbing, construction, foundation stumps, and many more.	9314539901808	
RPPHA150SA	507475	SPARE 150MM EARTH AUGER TO SUIT RPPHA150MM		
RPPHA200MM	507476	<b>POST HOLE DIGGER 52CC 200MM</b> 200mm Post Hole Digger 52cc Spring drive system - impact damper fully tested to suit Australian conditions auger length 850mm, 2 stroke petrol air cooled Ideal applications include: fence posts, retaining walls, tree planting, plumbing, construction, foundation stumps and many more	9314539901792	
RPPHA200SA	507477	SPARE 200MM EARTH AUGER TO SUIT RPPHA200MM		
RPPHA150HDSA	507473	SPARE 150MM H.DUTY EARTH AUGER TO SUIT RPPHA200MM		
<b>GENERATORS</b>				
RPG2500	507403	<b>GENERATOR 2.5KVA RECOIL START</b> 2.5 Kva 6.5 Hp generator 4-Stroke petrol engine 2.5 Kva peak output Automatic voltage regulator (AVR) Up to 13 hours run time, Dual pole main switch for added safety • Two power outlets with protective flaps • Digital volt/hour meter for monitoring voltage, frequency, run time and total hours • 240 V & 12 V outputs for versatility • Ideal application includes camping, power tools, lighting etc.	9314539903277	
RPG3000RCD	507425	<b>GENERATOR 3KVA RECOIL START</b> 3.125KVA - 6.5HP GENERATOR WITH RCD POWERFUL 6 5 HP 4-STROKE PETROL ENGINE 3.125 KVA PEAK OUTPUT RESIDUAL CURRENT DEVICE (RCD) FOR ADDITIONAL ON SITE SAFETY, GENUINE SENCi ALTERNATOR • Dual pole main switch and (RCD) for added safety • Automatic Voltage Control (AVR) for output regulation • Two power outlets with protective flaps • Recoil start • Ideal for building sites	9314539903338	
RPG3500	507426	<b>GENERATOR 3.5KVA RECOIL START</b> 3.5 KVA 7.0 HP GENERATOR POWERFUL 7 HP 4-STROKE PETROL ENGINE 3.5 KVA PEAK OUTPUT HEAVY DUTY COPPER WOUND ALTERNATOR AUTOMATIC VOLTAGE REGULATOR (AVR) Dual pole main switch for added safety • 240V & 12V outputs for versatility • Two power outlets with protective flaps • Digital volt/hour meter for monitoring voltage, frequency, run time and total hours • Ideal applications include; camping, virtually all power tools, lighting, many domestic appliances etc.	9314539903284	







PART NO.	ITEM	DESCRIPTION	BARCODE	IMAGE
RPG6250	507429	<b>GENERATOR 6.25KVA ELECTRIC START</b> 6.25 KVA 13 HP GENERATOR POWERFUL 13HP 4-STROKE PETROL ENGINE ELECTRIC START GENUINE SENCI COPPER WOUND ALTERNATOR 6.25KVA PEAK OUTPUT • Wheel mount for easy portability • Dual pole main switch for added safety • 240V & 12V outputs for versatility • Three power outlets with protective flaps • Digital volt/hour meter for monitoring voltage, frequency, run time and total hours	9314539903291	
RPG6250RCD	507458	<b>GENERATOR BUILDERS 6.25KVA-REMOTE</b> 6.25 KVA 13HP GENERATOR WITH RCD POWERFUL 13HP 4-STROKE ENGINE REMOTE ELECTRIC START RESIDUAL CURRENT DEVICE (RCD) FOR ADDITIONAL ON SITE SAFETY GENUINE HEAVY DUTY SENCI COPPER WOUND ALTERNATOR Wheel mount for easy portability • Dual pole main switch and (RCD) for added safety • Automatic Voltage Control (AVR) for output regulation • 230V & 12V outputs for versatility • Two IP 66 rated power outlets with protective flaps • Digital volt/hour meter for monitoring voltage, frequency, run time and total hours • Ideal for building sites	9314539903307	
RPG8000RCD	507460	<b>GENERATOR 8KVA RECOIL START</b> 8.125KVA - 15HP GENERATOR WITH RCD HEAVY DUTY WHEELS AND HANDLES CENTRE LIFTING BAR RESIDUAL CURRENT DEVICE (RCD) FOR ADDITIONAL ON SITE SAFETY, GENUINE SENCI COPPER WOUND ALTERNATOR Wheel mount for easy portability • Dual pole main switch and (RCD) for added safety • Automatic Voltage Control (AVR) for output regulation • Two 15A IP66 rated power outlets with protective flaps • Recoil start • Ideal for building site	9314539903321	
RPG8125S	507461	<b>GENERATOR 8.125KVA REMOTE ELECTRIC START</b> 8.15 KVA 15 HP SINE WAVE GENERATOR POWERFUL 15HP 4-STROKE PETROL ENGINE REMOTE ELECTRIC START GENUINE SENCI COPPER WOUND ALTERNATOR THD <5% • Low distortion sine wave output to a wider variety of applications. • Wheel mount for easy portability • Dual pole main switch for added safety • Automatic Voltage Control (AVR) for output regulation • 240V & 12V outputs for versatility • Three power outlets with protective flaps • Digital volt/hour meter for monitoring voltage, frequency, run time and total hours	9314539903314	
<b>POWER TOOLS</b>				
<b>ELECTRIC</b>				
R PAG750W	507400	<b>ANGLE GRINDER 115MM 750W</b> General purpose electric angle grinder 11,000 rpm ø115mm, M 14 spindle includes pin spanner and removable handle	9314539901297	

PART NO.	ITEM	DESCRIPTION	BARCODE	IMAGE
<b>PRESSURE WASHER</b>				
<b>ELECTRIC</b>				
RPPW1600E	507478	<p><b>PRESSURE WASHER 240V 1600W TURBO LANCE &amp; BRUSH</b>                      1600W 1500PSI PRESSURE WASHER,                      Powerful 1600 watt Electric motor, lightweight and portable automatic shut off. Powerful jet makes light work of cleaning vehicles, caravans, boats, garden furniture, tools, machinery.</p> <ul style="list-style-type: none"> <li>• Ideal for blasting paved areas, stone and iron work.</li> </ul> <p>Contains:                      1600W - 1500PSI pressure washer, high pressure hose/gun assembly, standard lance, turbo lance, detergent attachment, wash brush attachment.</p> <p>Optional Accessories:                      RPPWPC Patio cleaner and RPPWRB 180mm rotary brush</p> <p>Voltage 230 - 240V ~ 50 Hz, Rated input 1600W                      Pressure 1500PSI (MAX), Flow rate 5l/Min                      Hose length 3M, Mains Cable 5M, Weight 5.5kg</p>	9314539903840	
RPPW2000E	507494	<p><b>PRESSURE WASHER 240V 2000W TURBO LANCE &amp; BRUSH</b>                      2000W 1950PSI PRESSURE WASHER, Powerful 2000 watt Electric motor</p> <p>Wheel mounted with retractable handle, built in detergent bottle, automatic shut off</p> <ul style="list-style-type: none"> <li>• Powerful jet makes light work of cleaning vehicles, caravans, boats, garden furniture, tools, machinery.</li> <li>• Ideal for blasting paved areas, stone and iron work.</li> </ul> <p>Contains:                      High pressure hose, gun for lance, standard lance, turbo lance, wash brush attachment.</p> <p>Optional Accessories:                      RPPWPC Patio cleaner and RPPWRB 180mm rotary brush</p> <p>Voltage 230 - 240V ~ 50 Hz                      Rated input 2000W, Pressure 1950PSI (MAX)                      Flow rate 5.5l/Min, Hose length 5M                      Mains Cable 5M, Weight 8.8kg</p>	9314539903857	
RPPW2400EH	507497	<p><b>PRESSURE WASHER 240V 2400W TURBO LANCE &amp; BRUSH</b>                      2400W 2600PSI PRESSURE WASHER,                      Powerful 2400 watt induction motor</p> <p>Wheel mounted with retractable handle                      built in hose reel &amp; detergent bottle, automatic shut off</p> <p>Powerful jet makes light work of cleaning vehicles, caravans, boats, garden furniture, tools, machinery.</p> <ul style="list-style-type: none"> <li>• Ideal for blasting paved areas, stone and iron work.</li> </ul> <p>Contains:                      High pressure hose and reel, gun for lance, attachment adaptor, standard lance, turbo lance, wash brush attachment.</p> <p>Optional Accessories:                      RPPWPC Patio cleaner and RPPWRB 180mm rotary brush</p> <p>Voltage 230 - 240V ~ 50 Hz, Rated input 2400W                      Pressure 2600PSI (MAX), Flow rate 6l/Min                      Hose length 6M, Mains Cable 5M, Weight 20kg</p>	9314539903864	
RPPWPC	507563	<p><b>PATIO CLEANER TO SUIT 240V PRESSURE WASHER</b></p>	9314539903871	
RPPWRB	507564	<p><b>ROTARY BRUSH TO SUIT 240V PRESSURE WASHER</b></p>	9314539903888	

PART NO.	ITEM	DESCRIPTION	BARCODE	IMAGE
<b>PETROL</b>				
RPPW1900	507487	<p><b>PETROL PRESSURE WASHER 2.6HP 1900PSI</b>            1900 PSI 2.6HP PRESSURE WASHER            Compact and portable            Powerful 2.6HP 4 Stroke motor            ADJUSTABLE NOZZLE FOR Variable SPRAY PATTERNS            5m hose length            High-pressure cleaners with petrol engines guarantee the highest level of flexibility and independence.            • The powerful jet of water makes light work of cleaning vehicles, caravans, boats, garden furniture, tools, machinery etc.            • Ideal for cleaning blocked drains, blasting paved areas, stone and iron work</p> <p><b>MOTOR</b>            Type Air cooled 4 stroke            Maximum Power Output 2.6 HP @3500rpm            Displacement 87cc</p> <p><b>PUMP</b>            Max Pressure 1900psi (130bar), Rated Pressure 1300psi (90bar)            Rated Flow 6L/min</p> <p><b>GENERAL</b>            Hose Length 5M            Nozzle Variable Pattern and Detergent mode            Weight 21kg, Size 45 x 33 x 46cm</p>	9314539903802	
RPPW2600	507502	<p><b>PETROL PRESSURE WASHER 5.5HP 2600PSI</b>            2600 PSI 5.5HP PRESSURE WASHER            high pressure stainless steel lance            maintenance free, heavy duty pump            dual detergent dispenser bottles            meets european emission standards            High-pressure cleaners with petrol engines guarantee the highest level of flexibility and independence.            • The powerful jet of water makes light work of cleaning vehicles, caravans, boats, garden furniture, tools, machinery etc.            • Ideal for cleaning blocked drains, blasting paved areas, stone and iron work.</p> <p>Includes: 6 metre high pressure hose, heavy duty stainless steel lance, 5 interchangeable nozzles for different jet patterns</p> <p><b>MOTOR:</b> Type Air cooled 4 stroke            Maximum Power Output 5.5HP @3500rpm            Displacement 163cc</p> <p><b>PUMP</b>            Max Pressure 2600psi (180bar),            Rated Pressure 2000psi (140bar), Rated Flow 8L/min</p> <p><b>GENERAL</b>            Hose Length 6M, Nozzles 0, 15, 25, 40 Deg., Detergent            Weight 37kg, Size 59 x 57 x 45cm</p>	9314539903819	
RPPW3200	507545	<p><b>PETROL PRESSURE WASHER 196CC 3200PSI</b>            High Pressure, Stainless Steel Lance            Maintenance Free, Heavy Duty Pump            Dual Detergent Dispenser Bottles            5 interchangeable nozzles. 6 metre hose</p>	9314539901846	

PART NO.	ITEM	DESCRIPTION	BARCODE	IMAGE
RPPW4200	507550	<b>PETROL PRESSURE WASHER 13HP 4200PSI</b> 4200 PSI 13HP PRESSURE WASHER stainless steel lance with 5 interchangeable nozzles 10 metre high pressure hose super heavy duty pump meets european emission standards High-pressure cleaners with petrol engines guarantee the highest level of flexibility and independence. • The powerful jet of water makes light work of cleaning vehicles, caravans, boats, garden furniture, tools, machinery etc. • Ideal for cleaning blocked drains, blasting paved areas, stone and iron work Includes: 10 metre high pressure hose, heavy duty stainless steel lance, 5 interchangeable nozzles for different jet patterns	9314539903826	
<b>ACCESSORIES</b>				
RPPWH5M	507562	<b>PETROL PRESSURE WASHER EXTENSION HOSE 5M SUITS MODELS 2600,2900,3200</b>	9314539903833	
<b>WATER PUMP</b>				
<b>PETROL</b>				
RPWP125	507569	<b>PETROL WATER PUMP 1.5HP 25MM OUTLET</b> 1.5HP PETROL WATER TRANSFER PUMP POWERFUL 43CC TWO STROKE PETROL ENGINE DURABLE CAST IRON IMPELLOR 25MM INLET AND OUTLETS PORTS LIGHT WEIGHT AND PORTABLE Suitable for general purpose water transfer applications Outlet Size and Inlet Size - 25mm Speed - 6500rpm, Max. Flow - 7m3/h (7000L/h) Lift H. Max. - 20m, Suction - 7m Max. Output - 1.5HP Engine Type - Single Cylinder 2-stroke Forced Air Cooling Fuel: Oil ratio - 25:1, Bore x Stroke - 40 x 34mm Displacement - 43cc, Max Power Output - 1.25kw/6500rpm Fuel Tank Capacity - 1.2L, Weight - 9.5KGS	9314539903208	
RPWP150	507584	<b>PETROL WATER PUMP 5.5HP 50MM OUTLET</b> TRANSFER PUMP POWERFUL 163CC FOUR STROKE PETROL ENGINE DURABLE CAST IRON IMPELLOR 50MM INLET AND OUTLETS PORTS HEAVY DUTY FRAME Suitable for general purpose water transfer applications Outlet Size and Inlet Size - 50mm Speed - 3600rpm Max. Flow - 26m3/h (26000L/H) Lift H. Max. - 28m, Suction - 7m Max. Output - 5.5HP Engine Type - Single Cylinder 4-stroke Forced Air Cooling OHV Bore x Stroke - 68 x 45mm, Displacement - 163cc Max Power Output - 4.0kw/3600rpm Fuel Tank Capacity - 3.6L, Weight - 26KGS	9314539903215	
RPWP240	507617	<b>PETROL WATER PUMP 6.5HP 40MM OUTLET</b> HIGH PRESSURE PETROL WATER TRANSFER PUMP POWERFUL 196CC FOUR STROKE PETROL ENGINE DOUBLE IMPELLOR - IMPRESSIVE 70 METRE LIFT 38MM INLET AND OUTLETS PORTS HEAVY DUTY PROTECTIVE FRAME • Versatile water pump suitable for general purpose water transfer, irrigation and fire fighting applications Outlet Size and Inlet Size - 38mm Speed - 3600rpm, Max. Flow - 12m3/h (12,000L/h) Lift H. Max. - 70m, Suction - 7m Max. Output - 6.5HP Engine Type - Single Cylinder 4-stroke Forced Air Cooling OHV Bore x Stroke - 68 x 54mm, Displacement - 196cc Max Power Output - 4.8kw/3600rpm Fuel Tank Capacity - 3.6L, Weight - 27.5KGS	9314539903239	

PART NO.	ITEM	DESCRIPTION	BARCODE	IMAGE
<b>ACCESSORIES</b>				
RPWFFK	507565	<b>HOSE &amp; FITTING KIT TO SUIT 40MM FIRE FIGHTING</b> Fire Fighting Hose Kit 5 metre heavy duty suction hose 2 x 10 metre fire hoses All hoses fitted and ready to use This kit is designed to be used in conjunction with high pressure 38mm petrol water pumps such as the ROSS RPWP240 or similar. Meets Australian Standard AS1221	9314539903192	
RPWK1	507566	<b>HOSE &amp; FITTING KIT TO SUIT 25MM WATER PUMP</b> 10M x 25mm Lay Flat Hose Kit For watering and general purpose water transfer 3 metre heavy duty suction hose 10 metre lay flat hose All fitted and ready to use This kit is designed to be used in conjunction with 25mm (1" BSP) petrol water pumps such as the ROSS RPWP125 or similar. Hose nozzle can be easily removed for water transfer applications.	9314539903161	
RPWK2A	507567	<b>HOSE &amp; FITTING KIT (OUT) TO SUIT 50MM PUMP</b> 20M x 50mm Lay Flat Hose Kit For general purpose water transfer Multiple hoses can be joined together if a longer hose is required, Camlock fittings for easy attachment / removal & joining. All fitted and ready to use This kit is designed to be used in conjunction with 50mm (2" BSP) petrol water pumps such as the ROSS RPWP150 & RPWP250 or similar. Includes: An additional Type "200A" Camlock to attach to the pump outlet.	9314539903178	
RPWK2B	507568	<b>HOSE &amp; FITTING KIT (IN) TO SUIT 50MM PUMP</b> 5M x 50mm Suction Hose Kit Quality heavy duty reinforced PVC hose Camlock fittings for easy attachment / removal All fitted and ready to use This kit is designed to be used in conjunction with 50mm (2" BSP) petrol water pumps such as the ROSS RPWP150 & RPWP250 or similar. Includes: Heavy duty industry standard Camlock quick release fittings for easy attachment and removal. Polypropylene strainer (fitted) and an additional Type "200A" Camlock to attach to the pump inlet.	9314539903185	





PART NO.	ITEM	DESCRIPTION	BARCODE	IMAGE
<b>WELDER</b>				
<b>ARC MACHINE</b>				
RXT140P	511119	<b>ARC WELDER 140AMP</b> 140amp welding power - welds up to 6mm thick. Turbo fan cooled Domestic power supply, - uses standard 10amp power point. Accessories included: welding mask, chipping hammer/wire brush, electrode holder, earth clamp with cable & welding electrodes.	9314539017004	
RXT170P	507756	<b>ARC WELDER FAN COOLED 170AMP</b> Fan Cooled Arc Welder, Input Power 230 AC Frequency 50Hz , Rated No-load Voltage 48V AC Effective Input Current 12.5 Amps, Rated Duty Cycle 10% Output current (49— 156) 170A peak, Insulation Grade H Cooling Type Fan Cooled, Case Protection Class IP21S (Not suitable for use in rain), External Dimension: L x W x H 37cm x 17cm x 27cm, Weight kg 19.9kg	9314539901549	
<b>ARC CONSUMABLES</b>				
RXC1008	507717	<b>MILD STEEL ELECTRODE 2.0MM HANG PACK (10)</b> General purpose 2.00mm mild steel electrodes in handy pack of 10	9314539902386	
RXC1009	507718	<b>MILD STEEL ELECTRODE 2.5MM HANG PACK (10)</b> General purpose 2.5mm mild steel electrodes in handy pack of 10	9314539902393	
RXC1010	507719	<b>MILD STEEL ELECTRODE 3.2MM HANG PACK (10)</b> General purpose 3.25mm mild steel electrodes in handy pack of 10	9314539902409	
RXC1020	507729	<b>MILD STEEL GP ELECTRODE 2.5MM TRADE PACK (2.5KG)</b> General purpose 2.5mm mild steel electrodes in 2.5Kg Tradepack	9314539902508	
RXC1021	507730	<b>MILD STEEL GP ELECTRODE 3.2MM TRADE PACK (2.5KG)</b> General purpose 3.25mm mild steel electrodes in 2.5Kg Tradepack	9314539902515	
<b>INVERTER WELDER</b>				
RXT135E	507750	<b>INVERTER WELDER 135AMP</b> 35 Amp Inverter Welder , Electronic welder for Arc & Tig Max current 135amps, Rated duty cycle: 10% @135amps Complete with arc leads, 240v (10amp), Hot Start – easier to strike arc , Anti stick – Shuts down if electrode sticks, Arc force – current auto increase if arc length is too short	9314539901419	
RXT150E	507752	<b>INVERTER WELDER 150AMP</b> 150 Amp Inverter Welder, Electronic welder for Arc & Tig Max current 150amps, Rated duty cycle: 10% @140amps Complete with arc leads in blow mould case , 240v (10amp) Hot Start – easier to strike arc , Anti stick – Shuts down if electrode sticks, Arc force – current auto increase if arc length is too short	9314539901464	
RXT180E	507792	<b>INVERTER WELDER 180AMP</b> 180 Amp Inverter Welder, Welds up to 9mm mild steel, Turbo fan cooled - longer welding period, Thermal overload protection - automatically cuts out to prevent overheating. Includes - 4 metre welding cable set with electrode holder and 3 metre earth clamp with lead, Complete with arc leads in blow mould case, Hot Start – easier to strike arc, Anti stick – Shuts down if electrode sticks. Arc force – current auto increase if arc length is too short. Tig Accessories optional extra	9314539901495	

PART NO.	ITEM	DESCRIPTION	BARCODE	IMAGE
<b>MULTIFUNCTION</b>				
RXT180ACDC	507772	<b>AC/DC TIG/STICK WELDER 180AMP</b> 180 AMP AC/DC TIG/MMA AC/DC 180 amp tig & arc welds aluminium, stainless & alloy steels digital display for precision Pulse for extra thin metals • HF Start - easy tig start. • Adjustable: pre and post gas, slope, pulse, frequency, balance and arc force. • 2 Touch and 4 Touch trigger function. • Turbo fan cooled. Includes: TIG torch WP-26-5m, 3m earth cable with earth clamp, 4m gas hose, Gas regulator. All purpose TIG welder suitable for welding; carbon - alloy - stainless - steels and aluminium alloys	9314539901372	
RXT200EX	507793	<b>INVERTER WELDER 200AMP MIG/TIG/STICK</b> 200 AMP MIG/TIG/ARC WELDER 3 in 1 MIG-TIG-ARC SYNERGIC controlled 200A mig, Gas / GASLESS OPERATION VRD for additional safety IGBT inverter multi- function portable welder (MIG/TIG/ARC) • Digital display for precision • Heavy duty Euro torch. • Turbo fan cooled - increased duty cycle - A general purpose welder that fill the needs of most workshops. It also features short circuit, over/under voltage protection, 2 Touch/4 Touch trigger operation, spot timer, Includes: 2m grounding cable with earth clamp, 3m North QTB-160A MIG torch, Gas Regulator, Gas hose. Electrode holder and lead for arc welding sold separately	9314539901365	
<b>MIG MACHINE</b>				
RXT100P	507749	<b>GASLESS MIG WELDER 100AMP</b> 100 AMP Mig Welder, 100 amp welding power - welds up to 5mm mild steel Turbo fan cooled - longer period of welding Domestic power supply - uses standard 10amp power point Suitable for use with mini reels & 4.5kg reels of wire Trigger activated torch - only live when welding, for precision & safety, Heavy duty torch with larger (M6 thread) contact tips and shroud, Gasless mig welding - easy to use indoors & outdoors. Thermal overload protection - automatically cuts out to prevent overheating. Ready to weld - accessories included: welding mask, wire, chipping hammer/wire brush, torch & earth clamp with cable	9314539901457	
RXT150P	507754	<b>GAS/GASLESS MIG WELDER 150AMP</b> 150 Amp Gas / Gasless, Mig Welder 150 amp welding power - welds up to 6mm mild steel. Turbo fan cooled - longer period of welding. Domestic power supply - uses standard 10amp power point. Heavy duty torch with larger (M6 thread) contact tips and shroud. Trigger activated torch - only live when welding, for precision & safety. Dual purpose mig welding - gas & gasless operation. Thermal overload protection - automatically cuts out to prevent overheating Ready to weld (gasless mode only) - accessories included: welding mask, wire, chipping hammer/wire brush, torch, earth clamp with cable & regulator for disposable gas bottle. Disposable gas bottle available as optional extra.	9314539901471	
RXT175P	507771	<b>GAS/GASLESS MIG WELDER 175AMP</b> 175 Amp Gas / Gasless, Mig Welder, 175 Amp Gas / Gasless Mig Welder. Welds up to 8mm mild steel, 6 output settings Wire sizes: Flux core 0.8 - 0.9mm, Solid 0.6 - 0.8mm Domestic power supply - uses 15amp power point	9314539901488	

PART NO.	ITEM	DESCRIPTION	BARCODE	IMAGE
RXT175ET	507757	<b>MIG WELDER 175AMP WITH EURO TORCH</b> 175AMP MIG WITH EURO TORCH 175 amp WELDING POWER Welds up to 8mm mild steel, Gas / Gasless Operation heavy duty EURO TORCH, Heavy duty steel construction • Turbo fan cooled • Ready to weld (in gasless mode only) Includes: 2m grounding cable with earth clamp, 3m North QTB-160A MIG torch, Gas Regulator, Gas hose and starting rolls of gas and gasless welding wire	9314539901396	
RXT250EX	507809	<b>WHEEL MOUNTED INVERTER MIG/MMA 250AMP</b> 250 AMP INVERTER MIG/ARC WELDER Single phase INVERTER 250A mig & 225A arc Gas / GASLESS OPERATION VRD for additional safety heavy duty type 24 euro torch IGBT inverter multi- function welder (MIG/ARC). • Built-in tool storage draw. • Euro torch. • Turbo fan cooled. - A general purpose welder that fill the needs of most workshops. It also features short circuit, over/under voltage protection, 2 Touch /4 Touch trigger operation, arc and burn-back controls Includes: 3m grounding cable with earth clamp 3m North N24-3 MIG torch, Gas Regulator, Gas hose Electrode holder and lead for arc welding sold separately	9314539901358	
<b>MIG CONSUMABLES</b>				
RXC1028	507739	<b>ALUMINIUM WELDING WIRE 0.8MM DIA. 0.5KG</b> For use in MIG welding aluminium together with a shielding gas.	9314539902584	
RXC1002	507712	<b>CONTACT TIPS M6 0.6MM (PACK OF 5)</b> For use with the larger M6 shroud & tips as fitted to NuWeld & Ross mig welders.	9314539902324	
RXC1001	507711	<b>CONTACT TIPS M6 0.8MM (PACK OF 5)</b> For use with the larger M6 shroud & tips as fitted to NuWeld & Ross mig welders.	9314539902317	
RXC1000	507710	<b>CONTACT TIPS M6 0.9MM (PACK OF 5)</b> For use with the larger M6 shroud & tips as fitted to NuWeld & Ross mig welders.	9314539902300	
RXC1017	507726	<b>CONTACT TIPS M5 0.6MM (PACK OF 5)</b> For use with the smaller M5 shroud & tip, eg SIP portable mig welders	9314539902478	
RXC1018	507727	<b>CONTACT TIPS M5 0.8MM (PACK OF 5)</b> For use with the smaller M5 shroud & tip, eg SIP portable mig welders	9314539902485	
RXC1019	507728	<b>CONVERSION KIT 1 (REG.ASSY.FOR DISP.BOT)</b> Enables mig welders that are designed for use with larger rented bottles to be used with disposable bottles. Kit includes: large bottle regulator, hose, pipe adapters & hose clips.	9314539902492	
RXC1014	507723	<b>FLUX CORED MIG WIRE 0.8MM X 0.45KG</b> For use with 'gasless MIGS' or dual purpose MIGS in gasless mode.	9314539902447	
RXC1015	507724	<b>FLUX CORED MIG WIRE 0.8MM X 0.9KG</b> For use with 'gasless MIGS' or dual purpose MIGS in gasless mode.	9314539902454	



PART NO.	ITEM	DESCRIPTION	BARCODE	IMAGE
RXC1027	507738	<b>FLUX CORED MIG WIRE 0.8MM X 4.5KG</b> For use with 'gasless MIGS' or dual purpose MIGS in gasless mode.	9314539902577	
RXC1006	507715	<b>MILD STEEL MIG WIRE 0.6MM X 5KG</b> For use in MIG welding together with a shielding gas.	9314539902362	
RXC1007	507716	<b>MILD STEEL MIG WIRE 0.8MM X 5KG</b> For use in MIG welding together with a shielding gas.	9314539902379	
RXC1012	507721	<b>MILD STEEL MIG WIRE 0.6MM X 0.7KG</b> For use in MIG welding together with a shielding gas.	9314539902423	
RXC1013	507722	<b>MILD STEEL MIG WIRE 0.8MM X 0.7KG</b> For use in MIG welding together with a shielding gas.	9314539902430	
RXC1016	507725	<b>SHROUD - STANDARD M5 (PACK OF 2)</b> For use with the smaller M5 shroud & tip, eg SIP portable mig welders	9314539902461	
RXC1029	507740	<b>STAINLESS STEEL WELDING WIRE 308 0.8MM X 0.7KG</b> For use in MIG welding stainless steel together with a shielding gas.	9314539902591	
RXC1004	507713	<b>STANDARD CONICAL SHROUD (PACK OF 2)</b> For use with the larger M6 shroud & tips as fitted to NuWeld & Ross mig welders.	9314539902348	
RXC1005	507714	<b>TORCH LINER</b> Suitable for Ross portable mig welders	9314539902355	

PART NO.	ITEM	DESCRIPTION	BARCODE	IMAGE
<b>MIG ACCESSORIES</b>				
RXC1023	507731	<b>CONVERSION KIT 3 (PORT MIG TO LARGE BOTTLE)</b> Enables mig welders that are designed for use with disposable bottles to be used with larger rented bottles. Kit includes: disposable bottle regulator, hose, pipe adapters & hose clips.	9314539902539	
RXC1024	507732	<b>GAS CYLINDER DISPOSABLE CO2</b> For convenience & economy Ross disposable gas bottles are a must. Co2 for general purpose mild steel welding where economy takes preference over the actual finish of the weld	9314539902546	
RXC1025	507734	<b>GAS CYLINDER DISPOSABLE ARGON/CO2</b> For convenience & economy Ross disposable gas bottles are a must. Argon/Co2 mixture - the technically preferred gas for mild steel welding with a smoother finish.	9314539902553	
RXC1026	507736	<b>GAS CYLINDER DISPOSABLE ARGON</b> For convenience & economy Ross disposable gas bottles are a must. Pure Argon gas - suitable for MIG welding aluminium and for TIG welding.	9314539902560	
RXC1024B	507733	<b>GAS CYLINDER DISPOSABLE CO2 (BOX OF 12)</b> For convenience & economy Ross disposable gas bottles are a must. Co2 for general purpose mild steel welding where economy takes preference over the actual finish of the weld (BULK PACK)	8004897145464	 12 Per Box
RXC1025B	507735	<b>GAS CYLINDER DISPOSABLE ARGON/CO2 (12)</b> For convenience & economy Ross disposable gas bottles are a must. Argon/Co2 mixture - the technically preferred gas for mild steel welding with a smoother finish. (BULK PACK)	8004897145501	
RXC1026B	507737	<b>GAS CYLINDER DISPOSABLE ARGON (BOX OF 12)</b> For convenience & economy Ross disposable gas bottles are a must. Pure Argon gas - suitable for MIG welding aluminium and for TIG welding. (BULK PACK)	8004897145518	

PART NO.	ITEM	DESCRIPTION	BARCODE	IMAGE
<b>PLASMA CUTTER</b>				
RXT40EP	507829	<b>PLASMA CUTTER 40AMP</b> 40 AMP PLASMA CUTTER 15mm max mild steel cut 20-40 Amp current range hf start - easy strike turbo fan cooled - improved duty cycle Includes: 4m PT31 torch, 3m earth cable and clamp, air hose and regulator	9314539901389	
RXT40EP/T4	507847	TIP FOR PLASMA CUTTING TORCH (4PK)	9314539902294	
RXT40EP/T3	507846	ELECTRODE FOR PLASMA CUTTING TORCH (2PK)	9314539902287	
RXT40EP/T2	507845	SWIRL RING FOR PLASMA CUTTING TORCH(2PK)	9314539902270	
RXT40EP/T1	507844	CUP FOR PLASMA CUTTING TORCH RXT40EP-2PK	9314539902263	
RXT40EP/43	507842	PLASMA TORCH PT-31		
<b>WELDING ACCESSORIES</b>				
RXC1011	507720	<b>BRASS REGULATOR FOR DISPOSABLE BOTTLE</b> The regulator is of sturdy brass construction which simply screws to the top of a disposable gas bottle. A quick release fitting is designed for quick and easy connection to the welders gas pipe. A control knob allows the adjustment of gas flow.	9314539902416	
RXCART	507741	<b>WELDING CART</b> Heavy Duty steel construction with rugged powder coat finish Solid mobile design - ideal for workshop use 252mm x 435mm top shelf suits most portable ARC, MIG, and TIG welders	9314539901440	
RXTIGTORCH	507849	<b>INVERTER TIG TORCH 9V + DISPOSABLE BOTTLE REGULATOR</b> Suitable for use with inverter welders fitted with dinse plug lead connections, eg Ross RXT135E, RXT150E, RXT160VRD & RXT180E. Includes: 9V TIG torch with leads & regulator for use with disposable bottle.	9314539901587	
RXWAG	507851	<b>WELDING APRON &amp; GLOVE SET</b> Quality leather construction provides the required protection against sparks & weld spatter.	9314539901433	

PART NO.	ITEM	DESCRIPTION	BARCODE	IMAGE
<b>WELDING HELMETS</b>				
RXH100F	507742	<b>AUTO WELDING HELMET SHADE 11, ROSS</b> Automatic Welding Helmet Fixed Lens Fixed shade 11, Switching time: Light- dark 1/1250 sec. UV/IR Protection, Full Face and neck protection Solar powered with	9314539901501	
RXH300S	507745	<b>AUTO WELDING HELMET VARIABLE SHADE, ROSS</b> Automatic Welding Helmet Variable Shade Variable shade - 9-13, Switching time: Light- dark 0.6ms UV/IR Protection, Full Face and neck protection, Solar powered with battery backup Auto power off after 15 minutes Viewing area 90mm x 40mm, Delay & Sensitivity, Adjustment	9314539901525	
RXH300SK	507747	<b>AUTO WELDING HELMET VARIABLE SHADE KEVLAR FINISH</b> Automatic Welding Helmet Variable Shade Variable shade - 9-13, Switching time: Light- dark 0.6ms UV/IR Protection, Full Face and neck protection Solar powered	9314539901563	
RXHH	507748	<b>HEAD HARNESS TO SUIT RX WELDING HELMETS</b> The head harness is suitable for all Ross automatic welding helmets. Easy to fit, Remove mounting screws and dispose of old harness replace with new harness and retighten screws.		
RXHOL	506873	OUTER LENS T/S RXH100F & RXH300S (5PACK)	9314539017486	
RXHIL1	506871	INNER LENS COVER TO SUIT RXH100F 92X42MM PK5	9314539017493	
RXHIL2	506872	INNER LENS COVER TO SUIT RXH300S 94X45MM PK5	9314539017516	

# evOLUTION®

## POWER TOOLS

## POWER TOOLS

### BRAND OVERVIEW

*With over 20 years in the industrial power tool market, Evolution have established a well-earned reputation and are recognised worldwide as a market leader within the steel and fabrication industry.*

### ADVANCED TCT TECHNOLOGY

*Moving on from their specialist background in steel dry cutting technology, Evolution are now one of the fastest growing power tool brands in the world. Thriving on the success of a range of TCT Multipurpose Saws which cut Steel, Aluminium and Wood, along with many other exciting innovations.*

### evOLUTION STEEL®

*Industrially rated tools. These are saws which are designed and specified for cutting steel on a full time basis. Specific blades available for cutting Stainless Steel, Aluminium and Wood*

### evOLUTION BUILD®

*Professional standard machines, rivalling current wood cutting saws in the marketplace. However, these are truly multipurpose saws; cutting mild Steel, Aluminium and Wood with the same blade!*



## INNOVATION, NOT IMITATION



12 Month Warranty extends to Evolution machines ONLY. Blades are not covered by warranty. Evolution machines should be used with evolution blades only and we do not recommend the use of Evolution blades with other machines.

PART NO.	ITEM	DESCRIPTION	BARCODE
<b>EVOLUTION POWER TOOLS</b>			
<b>STEEL RANGE</b>			
EVO-EXTREME230-P	702762	<b>XTREME - 230mm TCT STEEL CIRCULAR Saw - no blade</b>	
EVO-EXTREME230	702761	<b>XTREME - 230mm TCT STEEL CIRCULAR Saw - Supplied with Steel Blade</b>	

This powerful Steel cutting circular saw tackles even the most demanding of tasks with incredible cutting capabilities through tough applications. The powerful 1750W motor allows the machine to breeze through mild Steel without heat build-up, burrs or the use of coolant. Features include a useful laser guide to assist with accurate cutting and the bevel tilt enhances the versatility of the saw. Cut Aluminium, Stainless Steel and Wood with the correct, specialist blade attached. The XTREME is powerful and strong, yet compact and portable. Steel blade can cut up to 80m of 6mm Mild Steel\*.

**SUPPLIED WITH**  
Carrying Case, 230mm Steel Cutting Blade, Side Handle, Wrench, Fence Guide, Safety Goggles, Two Batteries, Ear Plugs

**TECHNICAL SPECIFICATIONS**

Motor: 1750W  
 Maximum Box Cutting  
 Capacity 90° (6mm Wall): 84mm  
 Maximum Box Cutting  
 Capacity 45° (6mm Wall): 53mm  
 Maximum Cutting Depth (Mild Steel Plate): 12mm  
 Recommended Maximum duty cycle: 30min  
 Speed: 2700RPM  
 Weight: 9kg  
 \* Evolution Power Tools internal test data



PART NO.	ITEM	BLADE	DIA.	ARBOR	KERF	TEETH	MRPM	BARCODE
EVO-BLADE230-ST	702748	Steel	230mm	25.4mm	2mm	48	2700	849713000453
EVO-BLADE230-SS	702747	Stainless Steel	230mm	25.4mm	1.8mm	60	2700	849713000477
EVO-BLADE230-AL	702746	Aluminium	230mm	25.4mm	2.4mm	80	2700	849713000460



EVO-RAPTOR355-P	702855	<b>RAPTOR - 355mm TCT STEEL CHOP Saw - no blade</b>	
EVO-RAPTOR355	702854	<b>RAPTOR - 355mm TCT STEEL CHOP Saw - Supplied with Steel Blade</b>	

This incredible chop saw slices through mild steel with ease, producing no heat or burrs, leaving an instantly workable finish. It cuts Steel, Aluminium and Stainless Steel quickly, cleanly and without coolant. Utilising a powerful 2200W motor, the RAPTOR can handle even the most demanding on-site jobs. The cutting capacity is incredible too - 120x120mm Steel box section with a 6mm wall thickness. This no-nonsense machine is economical in its performance as well, typically a RAPTOR blade averages a jaw-dropping 1000 cuts in 50x50mm mild Steel with a wall thickness of 3mm\*. The amazing RAPTOR is a true power house and gives the user tremendous ability when it comes to cutting Steel.

**SUPPLIED WITH**  
355mm TCT Steel Cutting Blade, Jig Plate, Safety Guard, Hex Wrench, Safety Goggles, Ear Plugs

**TECHNICAL SPECIFICATIONS**

Motor: 2200W  
 Maximum Box Section  
 (6mm Wall) 90°: 120x120mm  
 Maximum Square (6mm Wall 45°): 89x89mm  
 Rectangle (6mm Wall 90°): 95x180mm  
 Rectangle (6mm Wall 45°): 78x110mm  
 Recommended Maximum duty cycle: 30min  
 Speed: 1450RPM  
 Weight: 23kg  
 \* Evolution Power Tools internal test data



PART NO.	ITEM	BLADE	DIA.	ARBOR	KERF	TEETH	MRPM	BARCODE
EVO-BLADE355/66-ST	702752	Steel	355mm	25.4mm	2.4mm	66	1500	849713000507
EVO-BLADE355/90-SS	702754	Stainless Steel	355mm	25.4mm	2.4mm	90	1500	849713000521
EVO-BLADE355/80-AL	702753	Aluminium	355mm	25.4mm	2.4mm	80	1500	849713000514
EVO-BLADE355-DMND	702755	Diamond Masonry	355mm	25.4mm	2.4mm	N/A	4400	849713011640



EVOLUTION POWER TOOLS

PART NO.	ITEM	DESCRIPTION	BARCODE
EVO-MD42	702805	<b>42mm MAGNETIC DRILL</b>	0849713033307
<p>Versatile, accurate and fast, with strong magnetic adhesion (1300kg f), the EVO-MD42 is an essential tool when performing heavy duty industrial and steel fabrication work. The cuts are precise and clean due to an optimised rotation speed (450rpm) and all popular broaching capacities are covered (12-42mm). Adjustable head system allows twist drills to be used to full capacity. Integrated Cooling System.</p> <p>SUPPLIED WITH Oil Coolant System, Hex Keys 2, 3, 4mm, 3 Handles, 1 Shipping Guard, Safety Strap</p> <p>TECHNICAL SPECIFICATIONS Motor: 1200W Maximum Cutter Dia: 42mm Maximum Cutting Depth: 50mm Recommended Maximum duty cycle: 30min Sound Pressure level (under load): 90dB (A) Weight: 10.9kg Coolant: Suitable for use with Water Soluble Non Fume Coolant Cutter Retainer Internal Diameter: 19mm Weldon Shank</p>			
			
EVO-CUTTERKIT/S	702759	<b>SHORT SERIES 25mm CUTTER SET</b>	0849713054111
<p>6 Piece 25mm depth cutter kit - Weldon Shank Includes 12, 14, 16, 18, 20 &amp; 22mm cutters, pilot pin and case</p>			
			
EVO-HTA47	702804	<b>CHUCK ADAPTOR ½" UNF THREAD</b>	
<p>Required for using drill chuck with magnetic drill</p>			
			
EVO-CYCLONE	702760	<b>CYCLONE SWARF COLLECTOR</b>	0849713000408
<p>Fabricating in Steel can be a messy business, Evolution have the perfect tool to quickly clean up your metal shavings and scrap pieces. Simply wave the Magnetic Stick over the metal shavings to pick them up, carry them over to your scrap barrel, pull the plunger and the shavings are neatly deposited. The Cyclone's magnet is strong enough to quickly clean up your biggest mess of metal shavings.</p>			
			

**PART NO.**
**ITEM**
**DESCRIPTION**
**BARCODE**
**BUILD RANGE - MULTIPURPOSE SAWS**

<b>EVO-RAGE</b>	<b>702847</b>	<b>RAGE - 185mm TCT Multipurpose Circular Saw</b>	849713009920
-----------------	---------------	---	--------------

A ground breaking circular saw featuring RAGE® technology (patent pending) it easily cuts mild Steel, Aluminium, Wood (even Wood with nails), & Plastics with one blade. The cut is fast, clean, with virtually no burrs or sparks. When cutting mild Steel, the RAGE cuts cold, no coolant is required, and because the material is cold it can be handled and worked on immediately. A combination of hi-torque motor and gearbox, heavy duty construction and ultra high grade TCT blade enables this saw to cut materials which simply weren't possible before. When cutting tough materials, the blade life isn't sacrificed. A blade can cut up to 50m of 6mm mild steel\* before a replacement is required. This is a truly innovative product breaking new ground in the power tool market.

**SUPPLIED WITH**

RAGE Multipurpose TCT Blade,  
Fence Guide, Carrying Case,  
Wrench, Safety Goggles, Ear Plugs

**TECHNICAL SPECIFICATIONS**

Motor: 1050W

Weight: 6.5kg

Speed (No Load): 3500RPM

Max Box Section (3mm Wall 90°): 55mm

Max Box Section (3mm Wall 45°): 35mm

Max Cutting Thickness (Mild Steel Plate): 6mm

Max Cutting Thickness (Wood 90°): 55mm

Max Cutting Thickness (Wood 45°): 35mm

Recommended Maximum duty cycle: 30min

\* Evolution Power Tools internal test data



PART NO.	ITEM	BLADE	DIA.	ARBOR	KERF	TEETH	MRPM	BARCODE
EVO-BLADE-RAGE185M	702758	Multipurpose	185mm	20mm	2mm	20	3500	849713009883
EVO-BLADE185-DMND	702743	Diamond Masonry	185mm	20mm	2.5mm	N/A	8000	849713011589



<b>EVO-RAGE2</b>	<b>702848</b>	<b>RAGE - 355mm TCT Multipurpose CHOP Saw</b>	849713011251
------------------	---------------	---	--------------

Continuously outperforms traditional abrasive Chop Saws, offering increased Economy, advanced guarding, no loss of cutting depth and multipurpose cutting. This is the next generation of Chop Saw. Featuring RAGE® technology, utilising a TCT blade rather than an abrasive wheel, this incredible machine has the ability to cut mild Steel, Aluminium & Wood with a single blade. The cut is fast, clean with no burr & virtually no sparks.

When cutting mild steel, the RAGE2 cuts cold, no coolant is required, and because the material is cold it can be handled and worked on immediately.

The impressive performance is economical too, offering up to 750 cuts in 50mm mild Steel box section\*, before a replacement blade is needed.

**SUPPLIED WITH**

RAGE2 Multipurpose TCT Blade, V-Jaw for Pipe Cutting,  
Hex Wrench, Safety Goggles, Ear Plugs

**TECHNICAL SPECIFICATIONS**

Motor: 2000W

Speed (No Load): 1450RPM

Box Section (6mm Wall 90°): 120mm

Rectangle (6mm Wall 90°): 95x180mm

Round (6mm Wall 90°): 130mm

Recommended Maximum duty cycle: 30min

Weight: 25.1kg

\* Evolution Power Tools internal test data



PART NO.	ITEM	BLADE	DIA.	ARBOR	KERF	TEETH	MRPM	BARCODE
EVO-BLADE355M	702756	Multipurpose	355mm	25.4mm	2.4mm	36	1450	849713011268
EVO-BLADE355-DMND	702755	Diamond Masonry	355mm	25.4mm	2.4mm	N/A	4400	849713011640





PART NO.	ITEM	DESCRIPTION	BARCODE
EVO-RAGE3	702849	RAGE - 255mm TCT Multipurpose SLIDING MITRE Saw	849713011343
<p>The world's first truly multipurpose Mitre Saw which cuts mild Steel, Aluminium &amp; Wood (even Wood with nails), with the same blade. This machine is an essential addition to any workshop. Like other machines utilising RAGE® technology, when cutting mild Steel the cut is fast and clean with virtually no burrs or sparks. There is no heat build up, the material is cool to the touch and can be handled right away. The RAGE3 is revolutionary in design as well as function, it features a unique in-line handle and trigger switch, enabling right or left handed use. The RAGE3 will cut a compound mitre through mild Steel box section! Rage blade system will produce up to 250 cuts per blade in 50mm Mild Steel box section*, before a replacement blade is required.</p> <p>SUPPLIED WITH RAGE3 Multipurpose TCT Blade, Twin Clamp Work Holding System, Dust Bag, Wrench, Safety Goggles, Ear Plugs</p> <p>TECHNICAL SPECIFICATIONS Motor: 2000W (Soft Start) Maximum Depth of Cut (90° Bevel): 75mm Maximum Width Cut (90° Mitre): 300mm Recommended Maximum duty cycle: 30min Speed (No Load): 2500RPM Weight: 21kg</p> <p>* Evolution Power Tools internal test data</p>			

PART NO.	ITEM	BLADE	DIA.	ARBOR	KERF	TEETH	MRPM	BARCODE
EVO-BLADE255M	702751	Multipurpose	255mm	25.4mm	2mm	28	2500	849713011374
EVO-BLADE255-DMND	702750	Diamond Tile	255mm	25.4mm	2mm	N/A	4400	849713011619

PART NO.	ITEM	DESCRIPTION	BARCODE
EVO-RAGE3DB	702850	RAGE - 255mm TCT Multipurpose SLIDING MITRE DOUBLE BEVEL Saw	849713028136
<p>The world's first truly multipurpose Mitre Saw which cuts mild Steel, Aluminium &amp; Wood (even Wood with nails), with the same blade. This machine is an essential addition to any workshop. Like other machines utilising RAGE® technology, when cutting mild Steel the cut is fast and clean with virtually no burrs or sparks. There is no heat build up, the material is cool to the touch and can be handled right away. The RAGE3 is revolutionary in design as well as function, it features a unique in-line handle and trigger switch, enabling right or left handed use. The RAGE3 will cut a compound mitre through mild Steel box section! Rage blade system will produce up to 250 cuts per blade in 50mm Mild Steel box section*, before a replacement blade is required.</p> <p>SUPPLIED WITH RAGE3 Multipurpose TCT Blade, Twin Clamp Work Holding System, Dust Bag, Wrench, Safety Goggles, Ear Plugs</p> <p>TECHNICAL SPECIFICATIONS Motor: 2000W (Soft Start) Maximum Depth of Cut (90° Bevel): 75mm Maximum Width Cut (90° Mitre): 300mm Recommended Maximum duty cycle: 30min Speed (No Load): 2500RPM Weight: 21kg</p> <p>* Evolution Power Tools internal test data</p>			

PART NO.	ITEM	BLADE	DIA.	ARBOR	KERF	TEETH	MRPM	BARCODE
EVO-BLADE255M	702751	Multipurpose	255mm	25.4mm	2mm	28	2500	849713011374
EVO-BLADE255-DMND	702750	Diamond Tile	255mm	25.4mm	2mm	N/A	4400	849713011619











For over 50 years TELWIN has been a worldwide leader in the manufacturing of Italian made welding machines, cutting systems and battery chargers.









TELWIN are present on 5 continents, with a range of products that serve any market; products aimed at all production fields, from the automotive to industry in general, to the building sector to shipyards, to all professional divisions to DiY.









PART NO.	ITEM	DESCRIPTION	BARCODE	IMAGE
<b>BATTERY CHARGERS</b>				
<b>SINGLE PHASE SUPPLY</b>				
TWNEVATRONIC12	509547	<b>AUTOMATIC BATTERY CHARGER NEVATRONIC 12 12V-6A</b> 240 volt - 10 amp 12 volt batteries Automatic electronic control of charging current. Charges and monitors, stops and restarts automatically as required Recommended for 40 ah to 50 ah batteries Ideal for those infrequently used batteries such as boats, carts etc. 6 amp maximum charge 4 amp continuous charge Weight 2.2 kg	8004897397283	
TWNEVATRONIC24	509548	<b>AUTOMATIC BATTERY CHARGER NEVATRONIC 24 12/24V 6/4.5A</b> 240 volt - 10 amp 12 & 24 volt batteries Automatic electronic control of charging current. Charges and monitors, stops and restarts automatically as required Recommended for 40 ah to 50 ah batteries Ideal for those infrequently used batteries such as boats, carts etc. 6/3 amp maximum charge 4/2 amp continuous charge Weight 2.4 kg	8004897470719	
TWAUTOTRONIC25	509513	<b>BATTERY CHARGER AUTOTRONIC 25 12-24V 18/12AMPS</b> 240 volt - 15amp 12 & 24 volt With engine boost facility to assist with starting part charged batteries. Ideal for those infrequently used batteries such as boats, carts agricultural, deep cycle and maintenance batteries. Weight 6.1kg	8004897652412	
TWNEVABOOST100	509541	<b>BATTERY CHARGER NEVABOOST 100 12VOLT-9/14AMPS</b> 240 volt - 10 amp Features automatic overload and polarity reversal protection Quick charge & Boost charge settings 9 amp maximum charge 14 amp boost charge settings 5.5 amp continuous charge 9 amp continuous boost Recommended for 55 ah to 180 ah batteries Weight 2.3 kg	8004897397290	
TWNEVABOOST140	509542	<b>BATTERY CHARGER NEVABOOST 140 12VOLT-20AMPS</b> 240 volt - 15 amp With engine boost facility to assist engine starting with part charged batteries Features automatic overload and polarity reversal protection Quick charge & Boost charge settings 20amp maximum charge 100 amp boost charge settings 13 amp continuous charge 50 amp continuous boost Recommended for 10 ah to 200 ah batteries Weight 5.3 kg	8004897413778	
TWNEVADA11	509543	<b>BATTERY CHARGER NEVADA 11 6/12VOLT-4AMPS</b> 240 volt - 10 amp Suitable for overnight charging of 6/12 volt lead acid batteries 4 amp maximum charge 2.5 amp continuous charge Recommended for 25 ah to 40 ah batteries Great for cars, motorcycles, ride-on mowers etc. Weight 1.6 kg	8004897397252	

**TELWIN**

PART NO.	ITEM	DESCRIPTION	BARCODE	IMAGE
TWNEVADA14	509544	<b>BATTERY CHARGER NEVADA 14 12VOLT -9AMPS</b> 240 volt - 10 amp Suitable for overnight charging of 12 volt lead acid batteries 9 amp maximum charge 6 amp continuous charge Recommended for 60 ah to 115 ah batteries Ideal for cars, boats, light commercial vehicles agricultural use etc. Weight 2.0 kg	8004897397269	
TWNEVADA15	509545	<b>BATTERY CHARGER NEVADA 15 12/24V-9/4.5AMPS</b> 12/24 volt - 9/4.5 amp Battery Charger 240 volt - 10 amp Suitable for overnight charging of 12/24 volt lead acid batteries 9/4.5 amp maximum charge 6/3 amp continuous charge Recommended for 60 ah to 115 ah batteries / 30 ah to 40 ah batteries Ideal for cars, boats, light commercial vehicles agricultural use etc. Weight 2.4 kg	8004897397276	
TWLEADER220	509530	<b>BATTERY CHARGER LEADER 220 12/24V-30AMPS</b> 240 volt - 15 amp 12/24 volt with boost & jump start settings ideal for cars vans and light trucks 30 amp maximum charge 180 amp jump - start 20 amp continuous charge 120 amp jump start continuous Recommended for 30 ah to 400 ah batteries Weight 9kg	8004897652429	
TWLEADER400	509531	<b>BATTERY CHARGER LEADER 400 12/24V-45AMPS</b> 240 volt - 15 amp 12/24 volt with boost & jump start settings ideal for cars vans and light trucks 45 amp maximum charge 300 amp jump - start 30 amp continuous charge 180 amp jump start continuous Recommended for 20 ah to 700 ah batteries Weight 10.7 kg	8004897383156	
TWDYNAMIC320	509520	<b>BATTERY CHARGER DYNAMIC 320 12/24V - 45AMPS</b> 240 volt - 15 amp 12/24 volt with boost & jump start settings ideal for cars vans and light trucks 45 amp maximum charge 300 amp jump - start 30 amp continuous charge 180 amp jump start continuous Recommended for 20 ah to 700 ah batteries Weight 14 kg	8004897534862	
TWDYNAMIC520	509521	<b>BATTERY CHARGER DYNAMIC 520 12/24V - 75AMPS</b> 240 volt - 15 amp 12/24 volt with boost & jump start settings ideal for cars trucks and tractors Features automatic overload and polarity reversal protection 75 amp maximum charge 480 amp jump - start 50 amp continuous charge 300 amp jump start continuous Recommended for 20 ah to 1000 ah batteries Weight 24 kg	8004897602639	

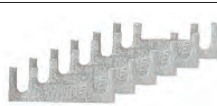
PART NO.	ITEM	DESCRIPTION	BARCODE	IMAGE
TWDYNAMIC620	509522	<b>BATTERY CHARGER DYNAMIC 620 12/24V - 90AMPS</b> 240 volt - 15 amp 12/24 volt with boost & jump start settings ideal for cars trucks and tractors Features automatic overload and polarity reversal protection 90 amp maximum charge 570 amp jump - start 70 amp continuous charge 360 amp jump start continuous Recommended for 20 ah to 1550 ah batteries Weight 26 kg	8004897374413	
<b>BATTERY CHARGER ACCESSORIES</b>				
TW802517	509423	<b>BATTERY TESTER 6-12VOLT (BLISTERED)</b>	8004897363103	
TW802528	509427	<b>BLACK EARTH CLAMP NEGATIVE 40A (BLISTERED)</b> Designed for use with Telwin battery chargers	8004897363219	
TW802530	509429	<b>BLACK EARTH CLAMP NEGATIVE 60A (BLISTERED)</b> Designed for use with Telwin battery chargers	8004897363233	
TW802527	509426	<b>RED EARTH CLAMP POSITIVE 40A (BLISTERED)</b> Designed for use with Telwin battery chargers	8004897363202	
TW802529	509428	<b>RED EARTH CLAMP POSITIVE 60A (BLISTERED)</b> Designed for use with Telwin battery chargers	8004897363226	
<b>FUSES</b>				
TW802255	510232	<b>10AMP FUSE (PK 10) SUIT NEVADA 15</b>	8004897148076	
TW802256	509404	<b>15AMP FUSE (PK 10) suit NEVADA14, NEVABOOST100, NEVATRONIC12/24</b>	8004897148083	
TW802257	509405	<b>20AMP FUSE (PK 10) SUIT AUTOTRONIC 25</b>	8004897148097	
TW122159	509132	<b>GLASS FUSE HOLDER TO SUIT CHARGERS</b>	8004897338873	
TW322051	509209	<b>FUSE COVER</b>		

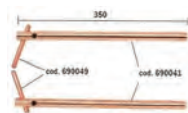
**TELWIN**

PART NO.	ITEM	DESCRIPTION	BARCODE	IMAGE
TW802258	509406	30AMP FUSE (PK 20) SUIT LEADER 220		
TW802259	509407	50A FUSE (PK 20) SUIT LEADER400 DYNAMIC 320	8004897148113	
TW802260	509408	80A FUSE (PK 20) SUIT LEADER220 DYNAMIC 520	8004897148120	
TW802029	509376	100AMP FUSE (PK 20) SUIT DYNAMIC 620	8004897500300	
<b>SPOT WELDERS</b>				
TWMODULAR20/TI	509536	<b>MODULAR PORTABLE SPOT WELDER 20/TI</b> Spot Welds up to 1 + 1mm Electronic Timer Adjustable pressure Heat insulated handle Modern Streamline Design 240 volt	8004897465647	
TWDIGITALMOD230	509518	<b>DIGITAL MODULAR 230 SPOT WELDER 2MM+2MM</b> Microprocessor controlled spot welder Maximum welding thickness 2 + 2 mm Automatic adjustment of welding time and current Manual adjustment also available Continuous or pulsed operation for specialised materials Adjustable arm pressure Supplied with arms 120mm Weight 11 Kg		
<b>ELECTRODES</b>				
TW803152	509449	<b>STRAIGHT ARM PAIR WITH ELECTRODES 250MM</b> Suitable for use with Telwin portable spot welders: TWMODULAR20/TI & TWDIGITALMOD230	8004897425788	
TW803153	509450	<b>STRAIGHT ARM PAIR WITH ELECTRODES 350MM</b> Suitable for use with Telwin portable spot welders: TWMODULAR20/TI & TWDIGITALMOD230		
TW803154	509451	<b>SHAPED ARM PAIR WITH ELECTRODES 350MM</b> Suitable for use with Telwin portable spot welders: TWMODULAR20/TI & TWDIGITALMOD230		







Maxus Compressors are specially designed for Nailing Applications. All units are lightweight and oil free



PART NO.	ITEM	DESCRIPTION	BARCODE	IMAGE
<b>NAILER COMPRESSOR</b>				
CHWX1001	501221	<p><b>MAXUS NAILER COMPRESSOR 0.5HP 4L OIL FREE</b>                      3.8 Litre 1/2 hp Induction motor                      10 amp plug, only 83 dB.                      High pressure -125 psi (8.6 bar)                      Only 10kg                      Ideal for brad &amp; fixing nailers</p>	45564626730	
CHWX801700DI	501222	<p><b>MAXUS NAILER COMPRESSOR 1HP 9.5L X LITE OIL FREE</b>                      2.5 Gal Maxus Lightweight Nailer Compressor                      1.1hp Induction motor - 10 amp plug - can be run off a 2.4KVA generator                      Very quiet, only 85dB. High pressure -135psi (9.3bar)                      Dual air outlets ("nitto type" couplers)                      Indexing pressure regulator for precise control                      Aircraft aluminium alloy twin tanks - 9.5 litre capacity                      Light weight, very portable – only 13.5kg                      Will operate one framing nail gun or two fixing nail guns continually</p>	45564623470	
CHWX8019	501223	<p><b>MAXUS NAILER COMPRESSOR 1.8HP 15L OIL FREE</b>                      15 Litre 1.8hp Induction motor                      10 amp plug, only 85 dB.                      High pressure -150psi (10.3bar)                      Light weight, only 25kg                      Will operate two framing nail guns continually</p>	45564625337	

## MAXUS Nailer Compressors for the Serious Builder

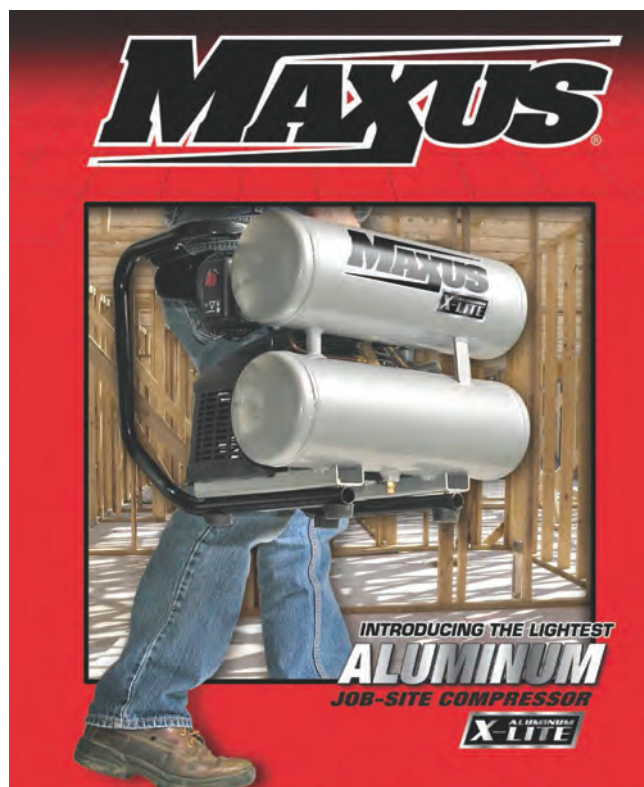







# BIANCO PUMPZ



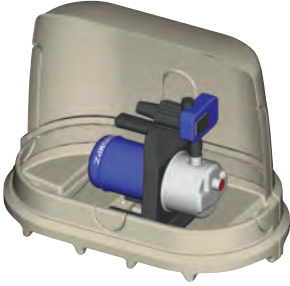

Over the last 10 years Bianco Pumpz has become one of the most renowned and recognised pump brands in the market for reliability and value for money.

There is a Bianco pump to suit almost every application. Whether it be a submersible or a surface mounted pump, think Bianco Pumpz for all your pumping needs.



PART NO.	ITEM	DESCRIPTION	BARCODE	IMAGE
<b>ELECTRONIC PRESSURE SYSTEMS</b>				
<b>Surface Mounted - Jet Pumps</b>				 <p>AS/NZS4020 approved for drinking water</p>
Suitable for water supply applications with suction wells, water supply and boosting of domestic systems. 2 Year Bianco Pumpz Warranty				
BIA-TECH40PC	700985	0.2kW, 0.3hp, 240V, max hd 27m, max flow 25L/m, 2 taps Ports 1" BSPF In, 1" BSPM Out	9312198855418	
BIA-INOX60PC	700723	0.33kW, 0.5hp, 240V, max hd 32m, max flow 36L/m, 3 taps Ports 1" BSPF In, 1" BSPM Out	9312198832419	
BIA-INOX80PC	700730	0.4kW, 0.6hp, 240V, max hd 40m, max flow 43L/m, 4 taps Ports 1" BSPF In, 1" BSPM Out	9312198855364	
BIA-INOX120PC	700680	0.6kW, 0.8hp, 240V, max hd 50m, max flow 50L/m, 5 taps Ports 1" BSPF In, 1" BSPM Out	9312198832457	 <p>AS/NZS4020 approved for drinking water</p>
<b>Surface Mounted - Horizontal Multistage Pumps</b>				
Ideal for medium to large homes. Suitable for high density urban applications. 2 Year Bianco Pumpz Warranty				 <p>AS/NZS4020 approved for drinking water</p>
BIA-MULTI900PC	700819	0.6kW, 0.8hp, 240V, max hd 36m, max flow 90L/m, 9 taps Ports 1" BSPF In, 1" BSPF Out	9312198849509	
BIA-MULTI1300PC	700767	1.0kW, 1.36hp, 240V, max hd 56m, max flow 90L/m, 9 taps Ports 1" BSPF In, 1" BSPF Out	9312198849523	
<b>Submersible</b>				
Ideal for domestic water supply. MPCX model includes SK13BA prewired and mounted on a stainless steel wall bracket. Complete with cover. 2 Year Bianco Pumpz Warranty				 <p>NEW</p> <p>AS/NZS4020 approved for drinking water</p>
BIA-B42AMPCX	711567	0.55kW, 0.75hp, 240V, max hd 32m, max flow 105L/m, discharge outlet size 1" BSPF, solids up to 3mm, 10 taps		

PART NO.	ITEM	DESCRIPTION	BARCODE	IMAGE
<b>PUMP COVER</b>				
WHI-PUMPCOVER	710824	Pump cover to suit pumps with fitted controllers - DAB or BIANCO Electronic Pumps Sturdy two piece design - base and lid Cut-out slots for inlet and outlet piping Ventilation in base and lid Beige colour Size: 640L x 340W x 601H (mm) All pumps must be protected from the elements.	9312198855357	
<b>ACCESSORIES</b>				
WHI-6BARPG	701439	Pressure Gauge 6 BAR Liquid Filled	8019203590593	
WHI-12BARPG	701379	Pressure Gauge 12 BAR Liquid Filled	8019203248753	
BIA-SKIT6	700970	Switch Kit complete with plug and play leads, pressure gauge, 1" non-return valve and nipple. Pressure switch has stainless steel back plate with union, and is adjustable between 1 and 6 bar. Factory setting is 1.4 – 2.8 bar, IP44 enclosure.		SK6
BIA-SK6	700968	LOSS OF PRIME PRESSURE SWITCH Pressure Switch Setting: 1 - 6 Bar Factory Setting: 1.4 - 2.8 Bar, 240V, 1 ph, Connection: 6mm (1/4") BSP, Indoor Use	9312198841954	
BIA-SK9A	700969	ADJUSTABLE PRESSURE SWITCH 6 BAR With stainless steel back plate Pressure Switch Setting: 1 - 6 Bar, Factory Setting: 1.4 - 2.8 Bar 240V, 1 ph, IP44, Connection: 6mm (1/4") BSP	9312198841961	SK9A
BIA-SK12(5M)	700965	5m Float Switch 10A with HO5 Neoprene Cable	9312198841978	
BIA-SK12(10M)	700962	10m Float Switch 10A with HO5 Neoprene Cable	9312198841985	
BIA-SK12(20M)	700963	20m Float Switch 10A with HO5 Neoprene Cable		
BIA-SK12(30M)	700964	30m Float Switch 10A with HO5 Neoprene Cable		
BIA-FSK1	700610	10 METRE FLOAT SWITCH WITH H07 NEOPRENE CABLE 240V, 1 ph, 16A max, "3 wire", IP68, max 50°C.	9312198848298	SKIT6
BIA-FSK1-20	700611	20 METRE FLOAT SWITCH WITH H07 NEOPRENE CABLE 240V, 1 ph, 16A max, "3 wire", IP68, max 50°C.		
BIA-SK12CWB	700967	FLOAT SWITCH COUNTERWEIGHT 200g gland mounting	9312198842593	SK12
WHI-PIGGYBACKFLOAT	700821	PIGGYBACK FLOAT SWITCH 16(8)A	9312198855302	
BIA-TSHKITA	701034	RAINWATER TANK SUCTION HOSE & FLOAT KIT	9312198847789	
BIA-SHKIT	700959	PRESSURE PUMP SUCTION HOSE KIT 0.7m	9312198854527	
BIA-DHKIT	700413	PRESSURE PUMP DISCHARGE HOSE KIT 1.4m		

PART NO.	ITEM	DESCRIPTION	BARCODE	IMAGE
<b>HOSE REELS</b>				
<b>BIA-ZA01-20B</b>	<b>701150</b>	<b>20m AIR REEL</b> 180° Swivel Rotation, Includes 20m Hose & Fittings, Convenient Carry Handle, Automatic Rewind, The Retractable Auto Hose Reel provides secure storage of your hose and allows you to extend and retract your hose without kinks and knots. 180° rotation extends your reach and allows you to reach all desired points within the hose length. The convenient carry handle enable you to move the hose reel between selected mounting points. Barcode: 9312198840193 12 Months Warranty	9312198840193	
<b>BIA-ZW03-20B</b>	<b>701153</b>	<b>20m WATER REEL</b> 180° Swivel Rotation, Includes 20m Hose & Fittings, Convenient Carry Handle, Automatic Rewind. The Retractable Auto Hose Reel provides secure storage of your hose and allows you to extend and retract your hose without kinks and knots. 180° rotation extends your reach and allows you to reach all desired points within the hose length. The convenient carry handle enable you to move the hose reel between selected mounting points. HOSE – 20 metre; Internal Diameter – 12mm (1/2"); Max. Pressure-1 000kPa(150 psi); Temp Range -5°C/45°C; Fittings: 3/4" NPT. 12 Months Warranty	9312198840186	
<b>BIA-ZW08-30B</b>	<b>701156</b>	<b>30m WATER REEL</b> The new BIA-ZW08-30B is a Retractable Auto Hose reel which provides secure storage of the 30 metres of hose supplied and allows the user to extend and retract the hose without kinks and knots. The hose is simply unwound to any desired length. The BIA-ZW08-30B features a special slow and steady automatic rewind mechanism with locking stop. The hose reel is characterised by: Hose unwinding to any desired length. Slow and steady automatic rewinding with stop. 30 metre (100') hose length. 1.7 metre supply hose with quick release coupling and 3/4" tap connector. Spray nozzle with jet adjustment. Easy disassembly and transport for winter storage. 180° lateral pivoting. Liquid: Clean water temperature range: 0°– 45°C; Hose: Length: 30m (100'); Internal diameter: 12mm (1/2"); Maximum pressure: 1000 kPa (150psi). 12 Months Warranty	9312198855609	
<b>PLASTIC DRAINAGE PUMPS</b>				
<b>Submersible Drainage Pumps</b>				
Ideal for pits and confined spaces where floats do not work. Not suitable for construction sites, ponds, fountains or bio-treatment. 12 Month Bianco Pumpz Warranty				 BIA-JH400   BIA-JH40011
<b>BIA-JH400</b>	<b>700741</b>	0.4kW, 0.55hp, 240V, Plastic Construction, max hd 8m, max flow 125L/m, 1 1/2" BSPF outlet	9312198832051	
<b>BIA-JH40011</b>	<b>700742</b>	Auto Manual 0.4kW, 0.55hp, 240V, Plastic Construction, max hd 8m, max flow 125L/m, 1 1/2 BSPF outlet	9312198848335	
<b>BIA-JH900</b>	<b>700754</b>	0.9kW, 1.2hp, 240V, Plastic Construction, max hd 9m, max flow 225L/m, 1 1/2 BSPF outlet	9312198832075	

**BIANCO**  
PUMPZ

PART NO.	ITEM	DESCRIPTION	BARCODE	IMAGE
<b>PLASTIC VORTEX PUMPS</b>				
<b>Submersible Vortex Pumps</b>				
Designed to pump water with some organic. Capable of pumping non-abrasive solids in suspension up to 35mm particle size. 12 Month Bianco Pumpz Warranty				
<b>BIA-JH550B</b>	<b>700744</b>	0.55kW, 0.75hp, Plastic Construction, Vortex, max hd 7m, max flow 158L/m, 1 1/2" BSPF outlet 10m power cable Particle size 38mm	9312198832013	
<b>STAINLESS STEEL DRAINAGE</b>				
<b>Stainless Steel Drainage Pumps</b>				
Suitable for all dewatering tasks including pumping out sumps, flooded areas and drawing water from wells. 12 Month Bianco Pumpz Warranty				
<b>BIA-JH554</b>	<b>700745</b>	0.55kW, 0.75hp, 240V, Stainless Steel Construction, max hd 7.5m, max flow 140L/m, 1 1/4" BSPF outlet	9312198855821	
<b>BIA-JH754M</b>	<b>700750</b>	0.75kW, 1.0hp, 240V, Stainless Steel Construction, max hd 8.5m, max flow 180L/m, 1 1/4" BSPF outlet	9312198855838	
<b>STAINLESS STEEL VORTEX</b>				
<b>Stainless Steel Vortex Pumps</b>				
Suitable for all dewatering tasks including pumping out sumps, flooded areas and drawing water from wells. 12 Month Bianco Pumpz Warranty				
<b>BIA-JH554B</b>	<b>700746</b>	0.55kW, 0.75hp, 240V, Stainless Steel Construction, max hd 7m, max flow 167L/m, 1 1/4" BSPF outlet	9312198855845	
<b>BIA-JH754BM</b>	<b>700749</b>	0.75kW, 1.0hp, 240V, Stainless Steel Construction, max hd 8m, max flow 216L/m, 1 1/4" BSPF outlet	9312198855852	
<b>Calf Milk Pump</b>				
Designed to pump water with some organic. Capable of pumping non-abrasive solids in suspensions up to 35mm particle size. 12 Month Bianco Pumpz Warranty				
<b>BIA-Q550B</b>	<b>700835</b>	0.55kW, 0.75hp, 240V, Stainless Steel Construction, max hd 7m, max flow 160L/m, 1 1/2" BSPF outlet		

PART NO.	ITEM	DESCRIPTION	BARCODE	IMAGE
<b>LIGHT CONSTRUCTION PUMPS</b>				
<p>Designed for dewatering of construction sites and pits. General dewatering where there is abrasive material. Suitable for construction sites, storm water and basements. Can handle particles up to 25mm x 10mm. Cast iron pump body and corrosion resistant pump components. 12 Month Bianco Pumpz Warranty</p>				
<b>BIA-AHS05A</b>	<b>700282</b>	0.4kW, 0.55hp, 240V, max hd 12m, max flow 220L/m, 2" BSPF outlet	9312198854787	
<b>BIA-AHS10A</b>	<b>700301</b>	0.75kW, 1.0hp, 240V, max hd 18m, max flow 350L/m, 2" BSPF outlet	9312198854794	
<b>BIA-LAYFLATKIT</b>	<b>700755</b>	Lay Flat 20m 2" Hose		
<b>HIGH HEAD</b>				
<b>High Head Drainage Pump</b>				
<p>Designed for rainwater tanks and pumping clean water only. The pump has sufficient pressure to operate as a pressure system pump when wired to a suitable controller. Clean water only. 12 Month Bianco Pumpz Warranty</p>				 <p>AS/NZS4020 Drinking Water Approved</p>
<b>BIA-JH8003P</b>	<b>700751</b>	0.8kW, 1.1hp, 240V, max hd 30m, max flow 83L/m, 1 1/4" BSPM outlet	9312198848342	
<b>High Head Submersible Clean Water Pump</b>				
<p>Designed for AWTS and rainwater tanks. Ideal for dewatering of cellars and garages. Can pump clean or slightly dirty water. Features: Slotted strainer Built in 83mm pump riser Benefits: Improves water flow and stops the strainer blocking Draws water at higher oxygen levels Reduces anaerobic intake Advantages: Eliminates pump failures due to blocked strainers Improves water quality by reducing the intake of algae and anaerobic matter which makes the water smell bad and discolour clothing 2 Year Bianco Pumpz Warranty 5 Star Energy Rating</p>				 <p>83mm</p> <p>AS/NZS4020 Drinking Water Approved</p>
<b>BIA-B42A</b>	<b>711924</b>	0.55kW, 0.75hp, 240V, max hd 32m, max flow 105L/m, discharge outlet size 1" BSPF, solids up to 3mm		







PART NO.	ITEM	DESCRIPTION	BARCODE	IMAGE
<b>CAST IRON DRAINAGE</b>				
Ideal for dewatering of cellars and garages and can pump clean or slightly dirty water. Can handle particles up to 10mm. 2 Year Bianco Pumpz Warranty				
<b>BIA-B15A</b>	<b>700315</b>	0.15kW, 0.2hp, 240V, max hd 6m, max flow 160L/m, discharge outlet size 1 1/4" BSPF, solids up to 10mm	9312198855623	
<b>BIA-B25A</b>	<b>700317</b>	0.25kW, 0.33hp, 240V, max hd 8m, max flow 200L/m, discharge outlet size 1 1/2" BSPF, solids up to 10mm	9312198855630	
<b>BIA-B40A</b>	<b>700319</b>	0.4kW, 0.55hp, 240V, max hd 10m, max flow 300L/m, discharge outlet size 2" BSPF, solids up to 10mm	9312198855647	
<b>BIA-B75A</b>	<b>700321</b>	0.75kW, 1.0hp, 240V, max hd 14m, max flow 400L/m, discharge outlet size 3" BSPF, solids up to 10mm	9312198855654	
<b>CAST IRON VORTEX</b>				
Suitable for the dewatering of cellars, garages and aerated water treatment systems. Ideal to pump clean or slightly dirty water and can handle soft solid particles up to 30mm. 2 Year Bianco Pumpz Warranty				
<b>BIA-B15VA</b>	<b>700316</b>	0.15kW, 0.2hp, 240V, max hd 6m, max flow 160L/m, discharge outlet size 1 1/4" BSPF, soft solids up to 10mm	9312198855661	
<b>BIA-B25VA</b>	<b>700318</b>	0.25kW, 0.33hp, 240V, max hd 8m, max flow 200L/m, discharge outlet size 1 1/2" BSPF, soft solids up to 25mm	9312198855678	
<b>BIA-B40VA</b>	<b>700320</b>	0.4kW, 0.55hp, 240V, max hd 10m, max flow 300L/m, discharge outlet size 2" BSPF, soft solids up to 30mm	9312198855685	
<b>BIA-B75VA</b>	<b>700323</b>	0.75kW, 1.0hp, 240V, max hd 11m, max flow 430L/m, discharge outlet size 3" BSPF, soft solids up to 17mm	9312198855692	







PART NO.	ITEM	DESCRIPTION	BARCODE	IMAGE
<b>CAST IRON GRINDER &amp; CUTTER</b>				
<b>Bianco Cutter Pump</b>				
<b>BIA-B75KA</b>	<b>700322</b>	Used for pumping sewage and solid wastewaters. It is used to cut long soft stringy solids in suspension. 0.75kW, 1.0hp, 240V, max hd 13m, max flow 410L/m, BSPF outlet size 2" 2 Year Bianco Pumpz Warranty	9312198855708	
<b>Bianco Grinder Pump</b>				
<b>BIA-B120G</b>	<b>700314</b>	Used to pump sewage and solid wastewaters. Soft solids in suspension by grinding them into a slurry. 1.5kW, 2.2hp, 240V, max hd 23m, max flow 180L/m, BSPF outlet size 1 1/4" 2 Year Bianco Pumpz Warranty	9312198855715	
<b>Bianco Positive Displacement Grinder Pump High Pressure</b>				
The pump is a positive displacement grinder pump with a heavy duty cutter and cutter ring used to treat unstrained waste waters in "low" flow, high head applications. 2 Year Bianco Pumpz Warranty				
<b>BIA-PDG150MA</b>	<b>800252</b>	1.1kW, 1.5hp, 240V, with float switch, max hd 50m, max flow 50L/m, 1 1/4" BSPF outlet		
<b>BIA-PDG150M</b>	<b>800587</b>	1.1kW, 1.5hp, 240V, without float switch, max hd 50m, max flow 50L/m, 1 1/4" BSPF outlet		
<b>BIA-PDG150TA</b>	<b>800588</b>	1.1kW, 1.5hp, 415V, with float switch, max hd 50m, max flow 50L/m, 1 1/4" BSPF outlet		
<b>BIA-PDG150T</b>	<b>800589</b>	1.1kW, 1.5hp, 415V, without float switch, max hd 50m, max flow 50 L/m, 1 1/4" BSPF outlet		









## Positive Displacement Grinder Pumps...

- Cast iron pump body for durability under harsh conditions
- Available in single phase and three phase, with and without a float
- Heavy duty silicon carbide mechanical seal
- Cutter with cutter rings cuts solids to smallest possible size to reduce clogging
- Used for unstrained waste waters
- Perfect for low pressure sewer applications
- **Also available in Packed Pump Stations** - 900L, 1200L and 3000L sizes. Suitable for new house dwellings and low lying, hilly, sand or rocky areas. Price available on inquiry.

PART NO.	ITEM	DESCRIPTION	BARCODE	IMAGE
<b>CENTRIFUGAL PUMPS - SMALL</b>				
<b>Close Coupled Stainless Steel Motor Pump units</b>				
Suitable for water circulation, car washing, tank emptying, gardening, fountains, irrigation and vat washing. 12 Month Bianco Pumpz Warranty				
<b>BIA-BLC70-055</b>	<b>700338</b>	0.55kW, 0.75hp, 240V, max hd 19m, max flow 120L/m, Ports 1 1/4" BSPF In, 1" BSPF Out		
<b>BIA-BLC70-075</b>	<b>700341</b>	0.75kW, 1.0hp, 240V, max hd 25m, max flow 120L/m, Ports 1 1/4" BSPF In, 1" BSPF Out		
<b>BIA-BLC70-100</b>	<b>700343</b>	1.0kW, 1.5hp, 240V, max hd 30m, max flow 120L/m, Ports 1 1/4" BSPF In, 1" BSPF Out		
<b>BIA-BLC120-110</b>	<b>700325</b>	1.1kW, 1.5hp, 240V, max hd 25m, max flow 180L/m, Ports 1 1/4" BSPF In, 1" BSPF Out		
<b>BIA-BLC120-185</b>	<b>700327</b>	1.85kW, 2.5hp, 240V, max hd 37m, max flow 180L/m, Ports 1 1/4" BSPF In, 1" BSPF Out		
<b>BIA-BLC200-110</b>	<b>700331</b>	1.1kW, 1.5hp, 240V, max hd 21m, max flow 260L/m, Ports 1 1/2" BSPF In, 1" BSPF Out		
<b>BIA-BLC200-185</b>	<b>700335</b>	1.85kW, 2.5hp, 240V, max hd 29m, max flow 260L/m, Ports 1 1/2" BSPF In, 1" BSPF Out		
<b>ENGINE POWERED PUMPS</b>				
<b>BIA-HP15A</b>	<b>700629</b>	<b>5.5hp Fire Pump</b> The pump is a compact self-priming engine driven fire pump which is also ideal for high general duty applications. Supplied ready to operate complete with hose fittings and suction strainer. Heads to 55m, Flows to 330l/min, Suction to 7m, 1 x 1-1/2", 2 x 1" BSP male discharge ports, 1 x 1-1/2" BSP male suction port. Low Oil Level Engine Protection, Roll Frame, Rubber Mounting Feet 12 MONTH BIANCO PUMPZ WARRANTY	9312198842586	
<b>BIA-2HP15A</b>	<b>700238</b>	<b>6.5hp Twin Stage Fire Pump</b> The pump is a compact self-priming engine driven fire pump supplied ready to operate complete with hose fittings and suction strainer. Heads to 75m, Flows to 200l/min, Suction to 7m, 1 x 1-1/2", 2 x 1" BSP male discharge ports, 1 x 1-1/2" BSP male suction port, Low Oil Level Engine Protection, Roll Frame, Rubber Mounting Feet 12 MONTH BIANCO PUMPZ WARRANTY	9312198849868	
<b>BIA-WP20A</b>	<b>701111</b>	<b>5.5hp Tanker Pump</b> The pump is a compact self-priming engine driven 2" Tanker Pump supplied ready to operate complete with hose fittings and suction strainer. Designed for tank filling, water carts and dust suppression. Heads to 30m, Flows to 450l/min, Suction to 7m, 1 x 2" BSP male discharge ports, 1 x 2" BSP male suction port, Low Oil Level Engine Protection, Roll Frame, Rubber Mounting Feet 12 MONTH BIANCO PUMPZ WARRANTY	9312198854312	
<b>BIA-WP30A</b>	<b>701130</b>	<b>6.5hp GUSHER Pump</b> The pump is a compact self-priming engine driven 3" Gusher Pump supplied ready to operate complete with hose fittings and suction strainer. Designed for rapid dewatering tasks and tank filling applications. Heads to 30m, Flows to 1000l/min, Suction to 7m, 1 x 3" BSP male discharge ports, 1 x 3" BSP male suction port, Low Oil Level Engine Protection, Roll Frame, Rubber Mounting Feet 12 MONTH BIANCO PUMPZ WARRANTY	9312198854329	
<b>Performances quoted are intermittent maximum.</b>				

PART NO.	ITEM	DESCRIPTION	BARCODE	IMAGE
BIA-FTB50	700612	<b>5.5hp Fire 'Poly' Pump - Chemical Resistant</b> The pump is a compact self-priming engine driven Plastic pump supplied ready to operate complete with hose fittings and suction strainer. Heads to 30m, Flows to 580l/min, Suction to 7m, 1 x 2" male discharge ports, 1 x 2" male suction port, Low Oil Level Engine Protection, Roll Frame, Rubber Mounting Feet 12 MONTH BIANCO PUMPZ WARRANTY	9312198849882	
BIA-HP15AH-C	800496	<b>5.5hp Fire Pump With Honda Engine</b> The pump is a compact self-priming engine driven Firepump supplied ready to operate complete with hose fittings and suction strainer. Heads to 55m, Flows to 330l/min, Suction to 7m, 1 x 1-1/2", 2 x 1" BSP male discharge ports, 1 x 1-1/2" BSP male suction port, Low Oil Level Engine Protection, Roll Frame, Rubber Mounting Feet <b>HONDA</b> 3 YEAR BIANCO PUMPZ WARRANTY	9312198856477	
BIA-2HP15AH-A	800497	<b>5.5hp Twin Stage Fire Pump With Honda Engine</b> The pump is a compact self-priming engine driven Firepump supplied ready to operate complete with hose fittings and suction strainer. Heads to 75m, Flows to 200l/min, Suction to 7m, 1 x 1-1/2", 2 x 1" BSP male discharge ports, 1 x 1-1/2" BSP male suction port, Low Oil Level Engine Protection, Roll Frame, Rubber Mounting Feet <b>HONDA</b> 3 YEAR BIANCO PUMPZ WARRANTY	9312198856484	
BIA-WP10AA	701064	<b>1.5hp Portable Engine Pump</b> The pump is a light weight self-priming general duty engine driven pump. Supplied ready to operate complete with hose fittings and suction strainer. 2 Stroke engine. Heads to 22m, Flows to 116l/min, Suction to 7m, 1" BSP female ports, Carry Frame, Rubber Mounting Feet 12 MONTH BIANCO PUMPZ WARRANTY		
BIA-WB80	701056	<b>6.5hp Trash Pump</b> The pump is a compact self-priming engine driven trash pump with features that include easy maintenance wear plate, wear resistant silicon carbide mechanical seal, easy impeller removal, light weight aluminium pump housing. supplied ready to operate complete with suction strainer. Soft solids to 30mm, Heads to 25m, Flows to 750l/m, Suction to 7m, 1 x 3" BSP male discharge port, 1 x 3" BSP male suction port, Roll Frame, Rubber Mounting Feet 12 MONTH BIANCO PUMPZ WARRANTY	9312198855777	
BIA-FFHK	700578	<b>Fire Fighting Hose Kit</b> The Fire Fighting Hose Kit comprises of: 1 x 5m x 38mm grey PVC suction hose c/w strainer, nut and tails plus 2 x 10m x 20mm black fire fighting delivery hose c/w nozzles, nuts and tails. 12 MONTH WARRANTY	9312198847543	

Performances quoted are intermittent maximum.

PART NO.	ITEM	DESCRIPTION	BARCODE	IMAGE
<b>BIA-DHP15</b>	<b>700415</b>	<p><b>6.5hp Diesel Powered Fire Pump</b>            The pump is a compact self-priming engine driven fire pump which is also ideal for high general duty applications. Supplied ready to operate complete with suction strainer.            Heads to 55m, Flows to 330l/min, Suction to 7m, 1 x 1-1/2", 2 x 1" BSP male discharge ports, 1 x 1-1/2" BSP male suction port, Recoil start with decompression lever. Roll Frame, Rubber Mounting Feet            12 MONTH BIANCO PUMPZ WARRANTY</p>	9312198855784	
<b>BIA-DHP20</b>	<b>700416</b>	<p><b>6.5hp Diesel Powered High Pressure Pump</b>            The pump is a compact self-priming engine driven high pressure pump which is also ideal for high general duty applications. Supplied ready to operate complete with suction strainer.            Heads to 65m, Flows to 500l/min, Suction to 7m, 1 x 2" BSP male discharge port, 1 x 2" BSP male suction port, Recoil start with decompression lever, Roll Frame, Rubber Mounting Feet            12 MONTH BIANCO PUMPZ WARRANTY</p>	9312198855760	
<b>BIA-DHP20E</b>	<b>700417</b>	<p><b>6.5hp Diesel Powered High Pressure Pump Electric Start</b>            The pump is a compact self-priming engine driven high pressure pump which is also ideal for high general duty applications. Supplied ready to operate complete with suction strainer.            Heads to 65m, Flows to 500 l/min, Suction to 7m, 1 x 2" BSP male discharge port, 1 x 2" BSP male suction port, Recoil start with decompression lever, Roll Frame, Rubber Mounting Feet            12 MONTH BIANCO PUMPZ WARRANTY</p>		
<b>BIA-2HP20A</b>	<b>700274</b>	<p><b>6.5hp Twin Stage High Pressure Pump</b>            The pump is a compact self-priming engine driven high pressure pump which is also ideal for high general duty applications. Supplied ready to operate complete with suction strainer.            Heads to 80m, Flows to 300 l/min, Suction to 7m, 2 x 1" BSP male discharge port, 1 x 1/2" BSP male suction port, Roll Frame, Rubber Mounting Feet            12 MONTH BIANCO PUMPZ WARRANTY</p>	9312198855791	
<b>BIA-SHP50</b>	<b>700960</b>	<p><b>13hp Cast Iron High Pressure Pump</b>            The pump is a compact self-priming engine driven high pressure pump which is also ideal for high general duty applications. Supplied ready to operate complete with suction strainer.            Heads to 100m, Flows to 500l/min, Suction to 7m, 1 x 2" BSP male discharge port, 1 x 2" BSP male suction port, Roll Frame, Rubber Mounting Feet            12 MONTH BIANCO PUMPZ WARRANTY</p>	9312198855807	
<b>BIA-TF2500</b>	<b>701031</b>	<p><b>2.0 kW Generator</b>            The generator is a compact AC and DC power source with circuit breaker protection. 5.5 hp engine with low oil shutdown. 2.2kW, 240V output, 8.0A 12V output. Roll Frame, Rubber Mounting Feet.            12 MONTH BIANCO PUMPZ WARRANTY</p>	9312198855814	

Performances quoted are intermittent maximum.

**BIANCO PUMPZ**

PART NO.	ITEM	DESCRIPTION	BARCODE	IMAGE
<b>PACKAGED PUMP STATIONS - LIFTING STATIONS</b>				
<b>Bianco Pump Stations</b>				
250 Litre collecting station, 730mm diameter x 900mm deep, access cover 600mm x 600mm, constructed for inground installation. Able to handle liquids such as storm water, trade waste, effluent and sewage depending on pump fitted. Standard with Polyethelene lid with optional Gatic cast iron access cover or galvanised storm water grate available. 2 Year Bianco Pumpz Warranty 12 Month Pump Station Warranty				    <p>Range of Pumps Supplied with Pump Stations</p>
<b>BIA-SERIES250-B40A</b>	<b>800373</b>	250 litre, vortex pump, 240V, 250W, max head 8m, flows to 200L/min		
<b>BIA-SERIES250-B40VA</b>	<b>800374</b>	250 litre, vortex pump, 240V, 400W, max head 10m, flows to 300L/min		
<b>BIA-SERIES250-B75KA</b>	<b>800375</b>	250 litre, cutter pump, 240V, 750W, max head 13m, flows to 410L/min		
<b>BIA-SERIES250-B120G</b>	<b>800376</b>	250 litre, grinder pump, 240V, 1500W, max head 23m, flows to 180L/min		
		Optional galvanised storm water grate Class B or Cast Iron Gatic Lid Class B		







# **Vacmaster**<sup>TM</sup>

With more than 15 years' experience in engineering and motor technology, Vacmaster incorporates the latest processes and highest standards of engineering, design and production. The result is high-quality products with exceptional performance and durability.





The Vacmaster product line includes portable wet/dry vacs that are great for any home or office, rugged yet easily manoeuvrable industrial stainless steel wet/dry vacs with a two-stage motor for heavy-duty use.

All products are made with the consumer in mind. Innovation and efficient design make Vacmaster easy to handle, use and store. Its heavy-duty motors deliver peak horsepower for maximum suction and all vacs come fitted with a float valve mechanism that shuts suction off to protect the motor from liquid overflow. Most Vacmaster wet/dry vacs convert quickly and easily to a powerful blower, perfect for clearing debris on patios, sidewalks and driveways.



PART NO.	ITEM	DESCRIPTION	BARCODE	IMAGE
<b>DOMESTIC VACUUMS</b>				
VMVQ1215P	509683	<b>WET/DRY VACUUM 15L 1250W</b> 15L Wet / Dry Vac (with 35mm accessory system) This compact size vac comes with a powerful 1250W motor. The 4m power cord and 1.5m secure fit hose offers a large cleaning coverage range. Easy to roll casters. Tough polypropylene tank. Top handle design - easy to carry. Large on / off switch. Built in accessory storage. Including 7 accessories: secure-fit hose, 3 extension wands, 2-in-1 floor brush/squeegee, dust filter, foam sleeve filter.	9314539901266	
VMVQ1220SS	509684	<b>WET/DRY VACUUM 20L WORKSHOP</b> 20L Stainless steel model with powerful 1250W motor and a maximum airflow of 58 L/Sec. Hose length 1.5m, cord length 4m, accessory diameter 35mm	9314539901235	
VMVQ1530SWDC	509686	<b>WET/DRY VACUUM 30L 1500W WITH SS TANK</b> 30L Stainless steel model with powerful 1500W motor, sync socket for automatic power-tool operation. max. air flow 65 l/sec max. vacuum 17kpa Comes with 2.5 metres of 35mm diameter hose 5m power cord for extra reach Synco function (900 Watt Max)	9314539901242	
<b>INDUSTRIAL VACUUMS</b>				
VMVF1515HJ	509658	<b>WET/DRY VACUUM 15L 1500W INDUSTRIAL</b> 1500 watt 15L max. air flow 60 l/sec max. vacuum 18kpa Comes with 1.8 metres of 35mm diameter hose 5m power cord	6939349500985	
VMVK1520SIW	509675	<b>WET/DRY VACUUM 20L 1500W INDUSTRIAL SS TANK</b> 20L Stainless steel model with powerful 1500W industrial, quiet two-stage motor and a maximum airflow of 60 L/Sec. Max. vacuum 18kpa. Heavy duty steel barrel fasteners and heavy duty wheels. Comes with 3.5m of 35mm diameter hose, cord length 5m. Synco function (900 Watt Max)	6939349501142	
VMVK1650SWDC	509678	<b>WET/DRY VACUUM 50L 1600W WITH SS TANK</b> voltage/frequency 230V~50Hz input rating 1600W 2 stage fan max. air flow 2.7m <sup>3</sup> /min max. vacuum 22kpa tank size 50L Stainless Steel cord length 7.5m Synco function (800 Watt Max) Standard accessories: 3.5m anti crush 38mm hose, metal tube set 3pc, crevice tool, 15" floor nozzle, dust bag, combo nozzle, Polyester cartridge filter, Prefilter, drain hose, accessory pouch	6939349510359	



PART NO.	ITEM	DESCRIPTION	BARCODE	IMAGE
VMVK1660SWDC	509680	WET/DRY VACUUM 60L 1600W WITH SS TANK voltage/frequency 230V~50Hz input rating 1600W 2 stage fan max. air flow 2.7m <sup>3</sup> /min max. vacuum 22kpa tank size 60L Stainless Steel cord length 7.5m Synco function (800 Watt Max) Standard accessories: 3.5m anti crush 38mm hose, metal tube set 3pc, crevice tool, 15" floor nozzle, dust bag, combo nozzle, Polyester cartridge filter, Prefilter, drain hose, accessory pouch	6939349510366	
<b>VACUUM ACCESSORIES</b>				
<b>ACCESSORIES</b>				
VMV3MK	509648	VACUUM ACCESSORY DETAIL CLEANING KIT TO SUIT 35MM HOSE Brushes & nozzles ideal for car cleaning and a whole lot more	6939349510241	
<b>BAGS</b>				
VM950137	509579	VACUUM BAG HIGH EFFICIENCY FILTER BAG (3 PIECE)T/S 15L	6939349510370	
VM950131	509576	VACUUM BAG HIGH EFFICIENCY FILTER BAG (3 PIECE) 30L	6939349510319	
VMVHBL	509659	VACUUM BAG HIGH EFFICIENCY FILTER BAG (3 PIECE) 50-60L Suitable for use with: VMVK1650SWDC & VMVK1660SWDC	6939349510326	
VM950130	509575	VACUUM BAG HIGH EFFICIENCY FILTER BAG (3 PIECE) 20L Suitable for use with: VMVWM1518R & VMVQ1220SS	6939349510302	
VM950136	509578	VACUUM BAG STANDARD FILTER BAG (3 PIECE) TO SUIT 15L	3551699501363	
VMFV9615.01.00	509626	VACUUM BAG LARGE DUST BAGS TO SUIT 50/60LTR.VAC -BULK		
VMFV9612.01.00	509624	VACUUM BAG DUST BAGS TO SUIT 20L VAC (PACK OF 5)	9314539027508	
VMFV9612.02.00	509625	VACUUM BAG DUST BAG TO SUIT 30L VACS (PACK OF 5)	9314539027492	
VM950072	509570	VACUUM BAG STANDARD FILTER BAG (3 PIECE) 20-30L	6939349500724	
<b>FILTERS</b>				
VMAT-18D	509582	VACUUM ACCESSORY ASH TANK METAL, FINE FILTER	6939349501982	
VMVRC2	509688	VACUUM CLOTH FILTERS TO SUIT 10L VAC (3 PIECE)	899794001436	
VMBLUEFILTER	509583	VACUUM DUST FILTER TO SUIT VJ1218 (3 PIECE) Cloth Filter bag to suit VMVJ1218P & VMVQ1220SS	9314539027461	
VM950175	509580	VACUUM FOAM FILTER TO SUIT VMVJ1010P (3 PIECE)	6939349501753	
VMFOAMFILTER	509587	VACUUM FOAM FILTER SUITS ALL VM MODELS (10 PIECE)	9314539027485	
VM950111	509573	VACUUM FOAM FILTER TO SUIT VMVF1515F (3 PIECE)	6939349501111	
VM950126	509574	VACUUM FOAM FILTER TO SUIT 20-60L (3 PIECE)	6939349501265	

PART NO.	ITEM	DESCRIPTION	BARCODE	IMAGE
VMFV9563.01.00	509622	VACUUM CARTRIDGE FILTER PET TO SUIT 50/60L Suitable for use with: VMVK1650SWDC & VMVK1660SWDC		
VM950108	509571	VACUUM CARTRIDGE FILTER TO SUIT VMVF1515F	6939349501081	
VMCARTFILTER	509585	CARTRIDGE FILTER TO SUIT VJ1223, VB1430 & VJ144 Suitable for use with: VMVJ1445PF, VMVQ1530SWDC, VMVB1330PF & VMVWM1518R	9314539027478	
VM950200	509581	VACUUM HEPA FILTER TO SUIT VMVF1515HJ		
VM9501100	509572	VACUUM HEPA FILTER TO SUIT VK1520SIW	6939349501104	
VMFV9644.04.00	509627	VACUUM PRE-FILTER TO SUIT 50/60L (BULK) Suitable for use with: VMVK1650SWDC & VMVK1660SWDC		
VM950134	509577	VACUUM FINE DUST FILTER CARTRIDGE (OVER 18L)	6939349501340	
<b>HOSES</b>				
VM35HOSE	509568	VACUUM HOSE SET 35MM X 1.5M		
VM64HOSE	509569	VACUUM HOSE SET 64MM X 2.1M		
VMFV5801.01.00	509597	VACUUM HOSE 38MM X 3.5M TO SUIT 50/60L Suitable for use with: VMVK1650SWDC & VMVK1660SWDC		

# PRYOR

## MARKING TECHNOLOGY

*Resourced with qualified mechanical, software and electronics engineers, PRYOR work in partnership with customers to produce state of the art turnkey marking systems.*

*PRYOR remain at the forefront of marking technology by evaluating new solutions to customer needs.*

*Markets: the markets we serve are many and varied, product identification being required in all industries. We are confident that our diverse experience will allow us to meet your marking needs.*

*PRYOR has consistent quality in marking, total service commitment and effective technical support.*



### **SPECIALISING IN:**

*Indenting Products • Tool Marking Products & Solutions  
Dot Marking & Laser Marking Solutions • Individual & Sets • Numbers & Letters*

PART NO.	ITEM	SIZE mm	SIZE Inch	PUNCH SIZE	IMAGE
----------	------	---------	-----------	------------	-------

**INTERCHANGEABLE STEEL TYPE**

Designed for multiple character marking using hand or machine holders. Precision ground blanks of Sheffield alloy steel Hardened and Tempered to 59-63 Rockwell 'C' scale. Nickel plated finish - resists rust and gives a good appearance. Gives clear character style for a quality mark on your product. High volume production ensures economical cost to you. Provides the perfect answer for all batch and general purpose marking. \* When ordering Interchangeable steel type, the character on the stamp comprises the last digit of the product code. Use \* for blank spacers. For character "/" use SLASH, for character "-" use DASH, for "" use FULLSTOP and for "," use COMMA. If you are not quite sure of your character size, match up dimension A and B to those above

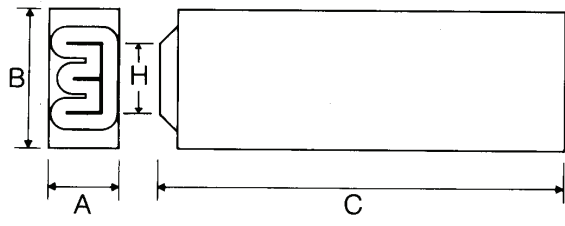

**SINGLE CHARACTERS**

PRYI010_*	^	1.0	.040	1.6 x 3.2 x 15.87
PRYI015_*	^	1.5	1/16	1.6 x 3.2 x 15.87
PRYI020_*	^	2.0	5/64	2.0 x 6.35 x 19.05
PRYI025_*	^	2.5	3/32	2.4 x 6.35 x 19.05
PRYI030_*	^	3.0	1/8	3.2 x 6.35 x 19.05
PRYI040_*	^	4.0	5/32	4.0 x 8.0 x 19.05
PRYI050_*	^	5.0	3/16	4.8 x 8.0 x 19.05
PRYI060_*	^	6.0	1/4	6.4 x 9.5 x 19.05
PRYI100_*	^	10.0	3/8	9.5 x 16.0 x 25.40



1-5mm do not have half moon cut-out  
6 & 10mm have half moon cut-out

**SETS OF 26 LETTERS: A-Z**

PRYIAS015	703926^	1.5	1/16	1.6 x 3.2 x 15.87
PRYIAS020	703927^	2.0	5/64	2.0 x 6.35 x 19.05
PRYIAS025	703928	2.5	3/32	2.4 x 6.35 x 19.05
PRYIAS030	703929^	3.0	1/8	3.2 x 6.35 x 19.05
PRYIAS040	703930^	4.0	5/32	4.0 x 8.0 x 19.05
PRYIAS050	703931^	5.0	3/16	4.8 x 8.0 x 19.05
PRYIAS060	703932^	6.0	1/4	6.4 x 9.5 x 19.05
PRYIAS100	703933^	10.0	3/8	9.5 x 16.0 x 25.40

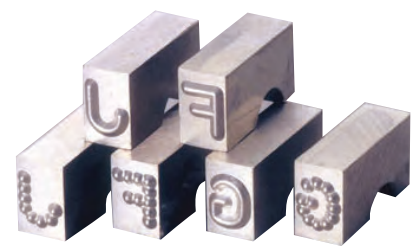

**SETS OF 10 NUMBERS: 0-9**

PRYINS010	703936^	1.0	.040	1.6 x 3.2 x 15.87
PRYINS015	703937^	1.5	1/16	1.6 x 3.2 x 15.87
PRYINS020	703938^	2.0	5/64	2.0 x 6.35 x 19.05
PRYINS025	703939^	2.5	3/32	2.4 x 6.35 x 19.05
PRYINS030	703940	3.0	1/8	3.2 x 6.35 x 19.05
PRYINS040	703941^	4.0	5/32	4.0 x 8.0 x 19.05
PRYINS050	703942	5.0	3/16	4.8 x 8.0 x 19.05
PRYINS060	703944^	6.0	1/4	6.4 x 9.5 x 19.05
PRYINS100	703945^	10.0	3/8	9.5 x 16.0 x 25.40



NOTE: MINISTRESS or DOTSTRESS TYPE IS AVAILABLE UPON REQUEST

PART NO.	ITEM	SIZE mm	SIZE Inch	PUNCH SIZE	IMAGE
----------	------	---------	-----------	------------	-------

**INTERCHANGEABLE STEEL TYPE FOUNT SETS**

The simple solution for multi-character marking using standard off the shelf type & holders. The set comes with or without hand holder.

**WITH HAND HOLDER**

PRY112H1M	703582 <sup>^</sup>	1.0	.040	1.6 x 3.2 x 15.87
PRY112HA	703584	1.5	1/16	1.6 x 3.2 x 15.87
PRY112H2M	703583 <sup>^</sup>	2.0	5/64	2.0 x 6.35 x 19.05
PRY112HB	703585	2.5	3/32	2.4 x 6.35 x 19.05
PRY112HC	703586	3.0	1/8	3.2 x 6.35 x 19.05
PRY106H4M	703574	4.0	5/32	4.0 x 8.0 x 19.05
PRY106HE	703575	5.0	3/16	4.8 x 8.0 x 19.05
PRY106HF	703576	6.0	1/4	6.4 x 9.5 x 19.05
PRY106HH	703577	10.0	3/8	9.5 x 16.0 x 25.40



Note: The 2,2.5 and 3mm sets come standard with the PRYH63529 Holder.  
If you want the larger PRYH63539 Holder listed below in second table, buy the items separately.

**WITHOUT HAND HOLDER**

PRY112A	703579 <sup>^</sup>	1.5	1/16	1.6 x 3.2 x 15.87
PRY1122M	703578 <sup>^</sup>	2.0	5/64	2.0 x 6.35 x 19.05
PRY112B	703580 <sup>^</sup>	2.5	3/32	2.4 x 6.35 x 19.05
PRY112C	703581 <sup>^</sup>	3.0	1/8	3.2 x 6.35 x 19.05

**INTERCHANGEABLE STEEL TYPE FOUNT SETS**



1 - 3mm sizes comprise - 100 pieces of type and 12 spacers. 4 - 10mm size comprise - 100 pieces of type and 6 spacers  
The 100 pieces of type in fount sets (with or without hand holder) comprise of -





<b>Character:</b>	A	B	C	D	E	F	G	H	I	J	K	L	M	N	O	P	Q	R	S	T	
<b>No. per set:</b>	3	2	2	2	4	2	2	2	3	2	2	3	2	3	3	2	1	3	3	2	
<b>Character:</b>	U	V	W	X	Y	Z	&	/	-	.	,	1	2	3	4	5	6	7	8	9	0
<b>No. per set:</b>	3	1	2	2	1	1	1	2	2	2	2	4	4	3	4	3	3	3	3	3	3

**HOLDERS FOR INTERCHANGEABLE STEEL TYPE FOUNT SETS**

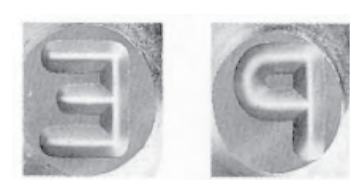
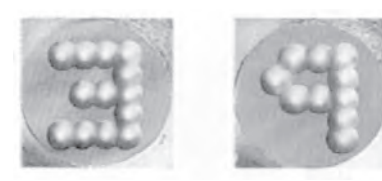
PART NO.	ITEM CODE	Capacity (number of types - one row only)								
		TYPE SIZE (mm)								
		1.0	1.5	2.0	2.5	3.0	4.0	5.0	6.0	10.0
PRYH3220	703602 <sup>^</sup>	12	12	-	-	-	-	-	-	-
PRYH63529	703603	-	-	14	12	9	-	-	-	-
PRYH63539	703604	-	-	19	16	12	-	-	-	-
PRYH8039	703605 <sup>^</sup>	-	-	-	-	-	9	8	-	-
PRYH9640	703606 <sup>^</sup>	-	-	-	-	-	-	-	6	-
PRYH1657	703601 <sup>^</sup>	-	-	-	-	-	-	-	-	6



PART NO.	ITEM	SIZE mm	SIZE Inch	PUNCH SIZE	IMAGE
<b>INDIVIDUAL HAND PUNCHES</b>					
<b>SINGLE PUNCHES (to indent a positive impression)</b>					
* When ordering the single priority punches, the character on the punch comprises the last figure of the product code					
PRYP010_*	Λ	1.0	.040	6.3sq x 63.5	
PRYP015_*	Λ	1.5	1/16	6.3sq x 63.5	
PRYP020_*	Λ	2.0	5/64	6.3sq x 63.5	
PRYP025_*	Λ	2.5	3/32	6.3sq x 63.5	
PRYP030_*	Λ	3.0	1/8	6.3sq x 63.5	
PRYP040_*	Λ	4.0	5/32	9.5sq x 70.0	
PRYP050_*	Λ	5.0	3/16	9.5sq x 70.0	
PRYP060_*	Λ	6.0	1/4	9.5sq x 70.0	
PRYP080_*	Λ	8.0	5/16	12.7sq x 89.0	
PRYP100_*	Λ	10.0	3/8	14.3sq x 89.0	
PRYP125_*	Λ	12.5	1/2	19.0sq x 89.0	
<b>SINGLE REVERSE PUNCHES (to indent a negative impression)</b>					
* When ordering the single reverse punches, the character on the punch is the 8th figure of the product code.					
PRYP015_*R	Λ	1.5	1/16	6.3sq x 63.5	
PRYP020_*R	Λ	2.0	5/64	6.3sq x 63.5	
PRYP030_*R	Λ	3.0	1/8	6.3sq x 63.5	
PRYP040_*R	Λ	4.0	5/32	9.5sq x 70.0	
PRYP050_*R	Λ	5.0	3/16	9.5sq x 70.0	
PRYP060_*R	Λ	6.0	1/4	9.5sq x 70.0	
<b>SINGLE HEAVY DUTY PUNCHES (to indent a positive impression)</b>					
* When ordering the single heavy duty punches, the character on the punch is the 8th figure of the product code.					
PRYP030_*HD	Λ	3.0	1/8	12.7sq x 102.0	
PRYP050_*HD	Λ	5.0	3/16	12.7sq x 102.0	
PRYP060_*HD	Λ	6.0	1/4	14.3sq x 102.0	
PRYP080_*HD	Λ	8.0	5/16	14.3sq x 102.0	
PRYP100_*HD	Λ	10.0	3/8	19.0sq x 102.0	
PRYP125_*HD	Λ	12.5	1/2	19.0sq x 102.0	
<b>SINGLE MINISTRESS PUNCHES (to indent a positive impression)</b>					
* When ordering the single ministress punches, the character on the punch is the 8th figure of the product code.					
PRYP030_*MS	Λ	3.0	1/8	9.5sq x 70.0	
PRYP050_*MS	Λ	5.0	3/16	9.5sq x 70.0	
PRYP060_*MS	Λ	6.0	1/4	12.7sq x 89.0	
<b>SINGLE DOTSTRESS PUNCHES (to indent a positive impression)</b>					
* When ordering the single dotstress punches, the character on the punch is the 8th figure of the product code.					
PRYP030_*DS	Λ	3.0	1/8	9.5sq x 70.0	
PRYP050_*DS	Λ	5.0	3/16	9.5sq x 70.0	
PRYP060_*DS	Λ	6.0	1/4	12.7sq x 89.0	
PRYP080_*DS	Λ	8.0	5/16	14.3sq x 89.0	

PART NO.	ITEM	SIZE mm	SIZE Inch	PUNCH SIZE	IMAGE	
<b>HAND PUNCH LETTER SETS (A-Z + &amp;)</b>						
<b>SETS OF 27 LETTER PUNCHES (to indent a positive impression)</b>						
PRYPAS010	704292 <sup>^</sup>	1.0	.040	6.3sq x 63.5		
PRYPAS015	704293	1.5	1/16	6.3sq x 63.5		
PRYPAS020	704295 <sup>^</sup>	2.0	5/64	6.3sq x 63.5		
PRYPAS025	704297	2.5	3/32	6.3sq x 63.5		
PRYPAS030	704298	3.0	1/8	6.3sq x 63.5		
PRYPAS040	704303	4.0	5/32	9.5sq x 70.0		
PRYPAS050	704305	5.0	3/16	9.5sq x 70.0		
PRYPAS060	704310	6.0	1/4	9.5sq x 70.0		
PRYPAS080	704315	8.0	5/16	12.7sq x 89.0		
PRYPAS100	704318	10.0	3/8	14.3sq x 89.0		
PRYPAS125	704320	12.5	1/2	19.0sq x 89.0		
<b>SETS OF 27 REVERSE LETTER PUNCHES (to indent a NEGATIVE impression)</b>						
PRYPAS015R	704294 <sup>^</sup>	1.5	1/16	6.3sq x 63.5		
PRYPAS020R	704296 <sup>^</sup>	2.0	5/64	6.3sq x 63.5		
PRYPAS030R	704302 <sup>^</sup>	3.0	1/8	6.3sq x 63.5		
PRYPAS040R	704304 <sup>^</sup>	4.0	5/32	9.5sq x 70.0		
PRYPAS050R	704309 <sup>^</sup>	5.0	3/16	9.5sq x 70.0		
PRYPAS060R	704314 <sup>^</sup>	6.0	1/4	9.5sq x 70.0		
<b>SETS OF 27 HEAVY DUTY LETTER PUNCHES (to indent a POSITIVE impression)</b>						
PRYPAS030HD	704300 <sup>^</sup>	3.0	1/8	12.7sq x 102.0		
PRYPAS050HD	704307 <sup>^</sup>	5.0	3/16	12.7sq x 102.0		
PRYPAS060HD	704312 <sup>^</sup>	6.0	1/4	14.3sq x 102.0		
PRYPAS080HD	704317 <sup>^</sup>	8.0	5/16	14.3sq x 102.0		
PRYPAS100HD	704319 <sup>^</sup>	10.0	3/8	19.0sq x 102.0		
PRYPAS125HD	704321 <sup>^</sup>	12.5	1/2	19.0sq x 102.0		
<b>SETS OF 26 MINISTRESS LETTER PUNCHES (A-Z Only)</b>						
PRYPAS030MS	704301 <sup>^</sup>	3.0	1/8	9.5sq x 70.0		
PRYPAS050MS	704308 <sup>^</sup>	5.0	3/16	9.5sq x 70.0		
PRYPAS060MS	704313 <sup>^</sup>	6.0	1/4	12.7sq x 89.0		
<b>SETS OF 26 DOTSTRESS LETTER PUNCHES (A-Z Only)</b>						
PRYPAS030DS	704299 <sup>^</sup>	3.0	1/8	9.5sq x 70.0		
PRYPAS050DS	704306 <sup>^</sup>	5.0	3/16	9.5sq x 70.0		
PRYPAS060DS	704311 <sup>^</sup>	6.0	1/4	12.7sq x 89.0		
PRYPAS080DS	704316 <sup>^</sup>	8.0	5/16	14.3sq x 89.0		

Letter Punches to indent a POSITIVE impression

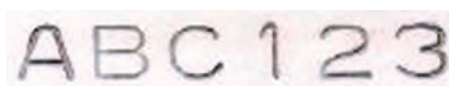







Mini Stress impression in Steel



Dot Stress impression in Steel

Highest quality steel marking punches made from Sheffield steel.  
 Made from top quality controlled Sheffield chromium tool steel and nickel plated  
 Hardened and tempered to precise limits to give long life and maximum safety  
 Available in a wide range of sizes and styles. Manufactured to BS5750 / ISO9001 quality standards  
 Packed in sets of Letters A-Z (including &) and Figures 0-9 in strong plastic boxes

PART NO.	ITEM	SIZE mm	SIZE Inch	PUNCH SIZE	IMAGE		
<b>HAND PUNCH NUMBER SETS (0-9)</b>							
<b>SETS OF 10 NUMBER PUNCHES (to indent a POSITIVE impression)</b>							
PRYPNS010	704325 <sup>^</sup>	1.0	.040	6.3sq x 63.5			
PRYPNS015	704326 <sup>^</sup>	1.5	1/16	6.3sq x 63.5			
PRYPNS020	704328 <sup>^</sup>	2.0	5/64	6.3sq x 63.5			
PRYPNS025	704330	2.5	3/32	6.3sq x 63.5			
PRYPNS030	704331	3.0	1/8	6.3sq x 63.5			
PRYPNS040	704336	4.0	5/32	9.5sq x 70.0			
PRYPNS050	704338	5.0	3/16	9.5sq x 70.0			
PRYPNS060	704343	6.0	1/4	9.5sq x 70.0			
PRYPNS080	704348	8.0	5/16	12.7sq x 89.0			
PRYPNS100	704351	10.0	3/8	14.3sq x 89.0			
PRYPNS125	704353	12.5	1/2	19.0sq x 89.0			
<b>SETS OF 10 REVERSE NUMBER PUNCHES (to indent a NEGATIVE impression)</b>							
PRYPNS015R	704327 <sup>^</sup>	1.5	1/16	6.3sq x 63.5			
PRYPNS020R	704329 <sup>^</sup>	2.0	5/64	6.3sq x 63.5			
PRYPNS030R	704335 <sup>^</sup>	3.0	1/8	6.3sq x 63.5			
PRYPNS040R	704337 <sup>^</sup>	4.0	5/32	9.5sq x 70.0			
PRYPNS050R	704342 <sup>^</sup>	5.0	3/16	9.5sq x 70.0			
PRYPNS060R	704347 <sup>^</sup>	6.0	1/4	9.5sq x 70.0			
<b>SETS OF 10 HEAVY DUTY NUMBER PUNCHES (to indent a POSITIVE impression)</b>							
PRYPNS030HD	704333 <sup>^</sup>	3.0	1/8	12.7sq x 102.0			
PRYPNS050HD	704340 <sup>^</sup>	5.0	3/16	12.7sq x 102.0			
PRYPNS060HD	704345 <sup>^</sup>	6.0	1/4	14.3sq x 102.0			
PRYPNS080HD	704350 <sup>^</sup>	8.0	5/16	14.3sq x 102.0			
PRYPNS100HD	704352 <sup>^</sup>	10.0	3/8	19.0sq x 102.0			
PRYPNS125HD	704354 <sup>^</sup>	12.5	1/2	19.0sq x 102.0			
<b>SETS OF 10 MINISTRESS NUMBER PUNCHES</b>							
PRYPNS030MS	704334 <sup>^</sup>	3.0	1/8	9.5sq x 70.0			
PRYPNS050MS	704341 <sup>^</sup>	5.0	3/16	9.5sq x 70.0			
PRYPNS060MS	704346 <sup>^</sup>	6.0	1/4	12.7sq x 89.0			
<b>SETS OF 10 DOTSTRESS NUMBER PUNCHES</b>							
PRYPNS030DS	704332 <sup>^</sup>	3.0	1/8	9.5sq x 70.0			
PRYPNS050DS	704339 <sup>^</sup>	5.0	3/16	9.5sq x 70.0			
PRYPNS060DS	704344 <sup>^</sup>	6.0	1/4	12.7sq x 89.0			
PRYPNS080DS	704349 <sup>^</sup>	8.0	5/16	14.3sq x 89.0			
<b>PUNCH HOLDERS</b>							
PRYPHG	704359	<b>PUNCH HOLDER SUITS INDIVIDUAL HAND PUNCHES</b> Suitable for all sizes • Designed to let you make heavy blows safely • Holds all sizes firmly, and allows a really hard blow to be struck without risk of jarring or damaging fingers					



PART NO.	ITEM	DESCRIPTION	BARCODE	IMAGE							
<b>HAND NUMBERERS - SERIES 2000<sup>^</sup></b>											
* When ordering Hand Numberers, the number of wheels comprises the last digit of the product code. Special character wheels with up to 11 characters can be made. The additional cost is shown at the bottom of this page. Number of standard wheels 0 - 9 + blank											
Part No.	Character Size mm	Number of Wheels Available									
		3	4	5	6	7	8	9	10	11	
PRYHN15_*	1.5										
PRYHN20_*	2.0										
PRYHN25_*	2.5										
PRYHN30_*	3.0										
PRYHN40_*	4.0										
PRYHN50_*	5.0										
PRYHN60_*	6.0										
NOTE: The most popular is 6 wheels. We usually have stock of sizes up to 3mm in 6 wheels											
<b>SPARE WHEELS and SPECIAL CHARACTER WHEELS<sup>^</sup></b>											
PART NO.	Spare Std Wheels Character Size (mm)										
PRYHN15W	1.5										
PRYHN20W	2.0										
PRYHN25W	2.5										
PRYHN30W	3.0										
PRYHN40W	4.0										
PRYHN50W	5.0										
PRYHN60W	6.0										
	Spare Special Character Wheel Size (mm)										
PRYHN15SCW	1.5										
PRYHN20SCW	2.0										
PRYHN25SCW	2.5										
PRYHN30SCW	3.0										
PRYHN40SCW	4.0										
PRYHN50SCW	5.0										
PRYHN60SCW	6.0										



PART NO.	ITEM	DESCRIPTION	BARCODE	IMAGE
----------	------	-------------	---------	-------

**ELECTRONIC MARKING MACHINES - BENCH MOUNTED**
**PRYOR MARKTRONIC LCD MARKMATE**

A bench mounted, fully programmable dot marking machine in a low cost simple to use package. Uncompromising build quality ensures the stand alone variable marking system is robust enough for the toughest workshop environments.

Ideal for a wide range of light duty industrial and commercial applications for small to medium size parts

**Applications Include:**

- Programmable marking • Component identification • Component traceability • Serial numbering • Logo marking • Security marking
- Health & safety appliance marking • Certification marking • Decorative trophy and award marking • Time and date marking • Part numbering
- Batch and shift coding • Calibration systems • Label and tag marking

**Technical Specification**

- Marking Area: 100mm x 75mm
- Std. Character Sizes: 0.18mm - 99.9mm in increments of 0.18mm
- Marking Formed: 5 x 7, 7 x 9, Varidot
- Marking Speed: Variable, depends on application
- Memory Capacity: 600 layouts

**Features:**
**Quiet, Efficient and Accurate Marking**

- Variable force control ensures optimum mark depth for all engineering materials up to 62 Rc (800 Hv)
- No air supply required - runs on standard mains current
- Highly efficient and significantly quieter than pneumatically actuated systems
- The lead-screw driven marking head guarantees dot precision unmatched on other low cost systems

**Separate Controller**

- The controller is a separate unit to ensure it is protected from the mechanical shock loading during the marking operation.
- The multilingual user-friendly interface allows users to choose between different character fonts and type sizes as well as angular and arc marking, serial numbers, date and time marking
- The easy to use software allows for 3 font types and up to 600 layouts to be stored

**The machine comes with a 12 months manufacturer's warranty.**

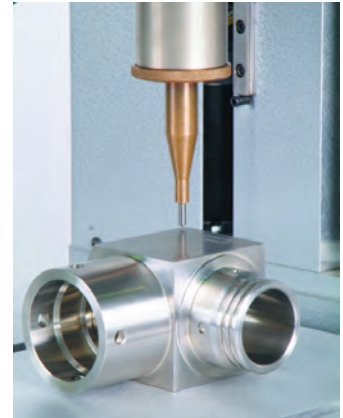

PRY3000LABEL



PRYFOOTSWITCH

PRYMARKMATE	703948	Bench mounted, Marking Area 100mm x 75mm
<b>ACCESSORIES AND SPARE PARTS</b>		
PRYSTY4X50	704374	Standard Stylus for Markmate 4 x 50mm
PRYSTYSPRINGMM	704379	Standard Stylus Spring for Markmate
PRYNOS4X50	703952	Standard Nose Piece for Markmate
PRY3000LABEL	703588	Label Fixture for name plates
PRYFOOTSWITCH	703600	Optional Start Pedal, Foot operated

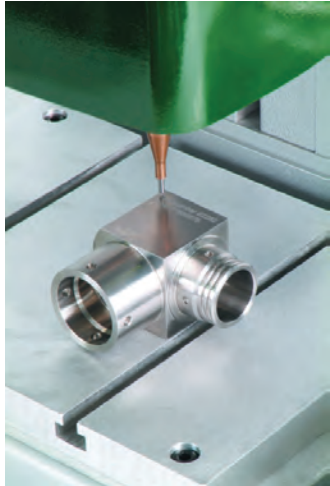

PART NO.	ITEM	DESCRIPTION	BARCODE	IMAGE
<b>PRYOR MARKTRONIC USB MARKMATE</b>				
<p>USB Plug and Play, fully programmable dot marking machine in a low cost package. PC driven via simple to use industry leading MARKMASTER Windows software. Ideal for a wide range of light duty industrial and commercial applications for small to medium size parts.</p> <p><b>Applications Include:</b></p> <ul style="list-style-type: none"> <li>• Programmable marking • Component identification • Component traceability • Serial numbering • Logo marking • Security marking</li> <li>• Health &amp; safety appliance marking • Certification marking • Decorative trophy and award marking • Time and date marking • Part numbering</li> <li>• Batch and shift coding • Calibration systems • Label and tag marking</li> </ul> <p><b>Technical Specifications</b></p> <ul style="list-style-type: none"> <li>• Marking Area: 100mm x 75mm</li> <li>• Std. Character Sizes: 0.18mm - 99.9mm in increments of 0.18mm</li> <li>• Marking Formed: 5 x 7, 7 x 9, Varidot, Windows true type fonts*, DXF, HPGL</li> <li>• Min PC Req: 1GHz Pentium or equivalent with USB port</li> <li>• Operating System: Windows 2000, Windows XP, Windows Vista, Windows 7 &amp; 8</li> </ul> <p><b>Features:</b></p> <p><b>Quiet, Efficient and Accurate Marking</b></p> <ul style="list-style-type: none"> <li>• Variable force control ensures optimum mark depth for all engineering materials up to 62 HRC (800 Hv)</li> <li>• No air supply required - runs on standard mains current</li> <li>• Highly efficient and significantly quieter than pneumatically actuated systems</li> <li>• The lead-screw driven marking head guarantees dot precision unmatched on other low cost systems</li> </ul> <p><b>MARKMASTER Software</b></p> <ul style="list-style-type: none"> <li>• Easy to use Windows based package combined with the USB connectivity brings printer like functionality to the field of permanent component dot marking</li> <li>• Enables on-screen creation of marking layouts using a simple drag and drop graphical interface.</li> <li>• Allows the creation and marking of logos using the in-built graphics tools, alternatively DXF and HPGL formats can be imported from other CAD systems.</li> <li>• Easy programming and tool path preview (machine outlines the marking position on the part itself)</li> <li>• The multilingual user interface allows users to choose between different character fonts and type sizes as well as angular and arc marking, serial numbers, date and time marking</li> </ul> <p><b>The machine comes with a 12 months manufacturer's warranty.</b></p>			  <p>PRY3000LABEL</p>  <p>PRYFOOTSWITCH</p>	
<b>PRYMARKMATE USB ADV</b>	<b>703949</b>	Bench mounted, Marking Area 100mm x 75mm		
<b>ACCESSORIES AND SPARE PARTS</b>				
<b>PRYSTY4X50</b>	<b>704374</b>	Standard Stylus for Markmate 4 x 50mm		
<b>PRYSTYSPRINGMM</b>	<b>704379</b>	Standard Stylus Spring for Markmate		
<b>PRYNOS4X50</b>	<b>703952</b>	Standard Nose Piece for Markmate		
<b>PRY3000LABEL</b>	<b>703588</b>	Label Fixture for name plates		
<b>PRYFOOTSWITCH</b>	<b>703600</b>	Optional Start Pedal, Foot operated		



PART NO.	ITEM	DESCRIPTION	BARCODE	IMAGE
<b>PRYOR MARKTRONIC BENCHDOT SERIES</b>				
<p>BENCHDOT series are robust dot marking machines designed for accuracy, speed, power and reliability. Used for FAST permanent marking of both small and large parts - the "Rolls Royce" in marking technology. Robust construction makes it well suited for applications in all environments.</p> <p>Units are available with a variety of standard marking windows – 60mm x 60mm, 100mm x 100mm, 150mm x 150mm and 300mm x 150mm.</p> <p><b>Applications Include:</b></p> <ul style="list-style-type: none"> <li>Permanently mark almost all engineering materials up to 62 HRC - (cast iron, stainless steel, plastics, aluminium and titanium alloys)</li> <li>Serial numbers, date codes, product reference, company logo, shift code, material batch</li> <li>2D Data Matrix code marking</li> <li>Identify small to large batches of components</li> <li>Marking on flat to uneven surfaces</li> <li>Circumferential marking device available (optional)</li> </ul> <p><b>Technical Specification</b></p> <ul style="list-style-type: none"> <li>Marking Area: 60mm x 60mm, 100mm x 100mm, 150mm x 150mm, 300mm x 150mm</li> <li>Std. Character Sizes: 0.15mm – 99.9mm in increments of 0.15mm</li> <li>Marking Formed: 5 x 7, 7 x 9, Varidot, Data Matrix coding</li> <li>Marking Speed: Extremely fast – 2 x 2.5mm characters per second</li> <li>Memory Capacity: 1350 layouts</li> </ul> <p><b>Features:</b></p> <p><b>Fast, Powerful and Accurate Marking</b></p> <ul style="list-style-type: none"> <li>Capable of deep marking on all engineering materials up to 62 Rc (800 Hv)</li> <li>No air supply required - runs on standard mains current</li> <li>High consistency of marking depth</li> <li>Fully controlled number of dots per character and dot location</li> <li>All models include a high quality ball screw mechanism with unique twin linear - rails and twin linear bearings on each axis and a rigid cast column and base</li> <li>Significantly quieter than pneumatically operated machines</li> </ul> <p><b>Intelligent Software</b></p> <ul style="list-style-type: none"> <li>The easy to use software allows for 4 standard font types and up to 1350 layouts to be stored</li> <li>Easy programming and tool path preview (machine outlines the marking position on the part itself)</li> <li>The multilingual user interface allows users to choose between different character fonts and type sizes as well as angular and arc marking, variable and serial numbers, date and time marking</li> <li>2D Data Matrix coding</li> </ul> <p><b>3000 Series Controller</b></p> <ul style="list-style-type: none"> <li>No need for a PC. The controller is a separate unit to ensure it is protected from the mechanical shock loading during the marking operation</li> <li>Very large and high contrast graphical screen ensures visuals at any angles</li> <li>Full QWERTY membrane keyboard (possibility of external keyboard)</li> <li>2 x RS232 communication port</li> <li>Digital I/O (8 Input, 6 Output)</li> <li>Ethernet TCP/IP (optional)</li> </ul> <p><b>All machines come with a 12 months manufacturer's warranty.</b></p>				
PRYBENCHDOT100	703592	Bench mounted, Marking Area 100mm x 100mm		 
PRYBENCHDOT150	703593	Bench mounted, Marking Area 150mm x 150mm		
PRYBENCHDOT300	703595	Bench mounted, Marking Area 300mm x 150mm		
<b>ACCESSORIES AND SPARE PARTS</b>				
PRYSTY3X100	704372 <sup>^</sup>	Standard Stylus for Benchdot Series 3mm x 100mm		 <p style="text-align: center;">PRY3000LABEL</p>  <p style="text-align: center;">PRYFOOTSWITCH</p>
PRYSTYSPRING3000	704378 <sup>^</sup>	Standard Stylus Spring for Benchdot Series		
PRYNOSEPIECE100	711888	Standard Nose Piece for Benchdot Series		
PRY3000LABEL	703588	Label Fixture for name plates		
PRYFOOTSWITCH	703600	Start Pedal, Foot operated		
PRYBARCODEREADER	703590 <sup>^</sup>	Bar Code Reader for 3000 Series Controller		

PART NO.	ITEM	DESCRIPTION	BARCODE	IMAGE
<b>PRYOR MARKMASTER SOFTWARE</b>				
Windows based software that allows connecting and operating the BENCHDOT marking units via PC. MARKMASTER is developed using the latest .net technology and is the most powerful PC based direct part mark software available.				
<b>Features include:</b>				
<ul style="list-style-type: none"> <li>• Extensive material settings library</li> <li>• Tool path preview with individual vector visualization</li> <li>• Advanced Database connectivity features - query marking data from and write back to Excel, Access, SQL Server, MySQL etc.</li> <li>• Off-line layout programming</li> <li>• Extensive library of high speed dot and vector fonts (inc. all Windows True Type Fonts)</li> <li>• Graphical shape tools</li> <li>• HPGL/DXF/BMP/JPG file importer for logo marking</li> <li>• Highly configurable serial numbering features</li> <li>• 1D and 2D barcode support with advanced Data Matrix cell fill control for marking extremely small DMx codes</li> <li>• Programmable user prompts with barcode scanner interface</li> <li>• Multi-Object 'editing and pilot beam' previewing</li> <li>• Automatic Z axis control for marking varied height parts</li> <li>• Rotary / circumferential axis control for marking around cylindrical parts.</li> <li>• Multi-lingual</li> </ul>				
PRYMARKMASTER 3000	703947 <sup>^</sup>	Marking Software for BENCHDOT series units		

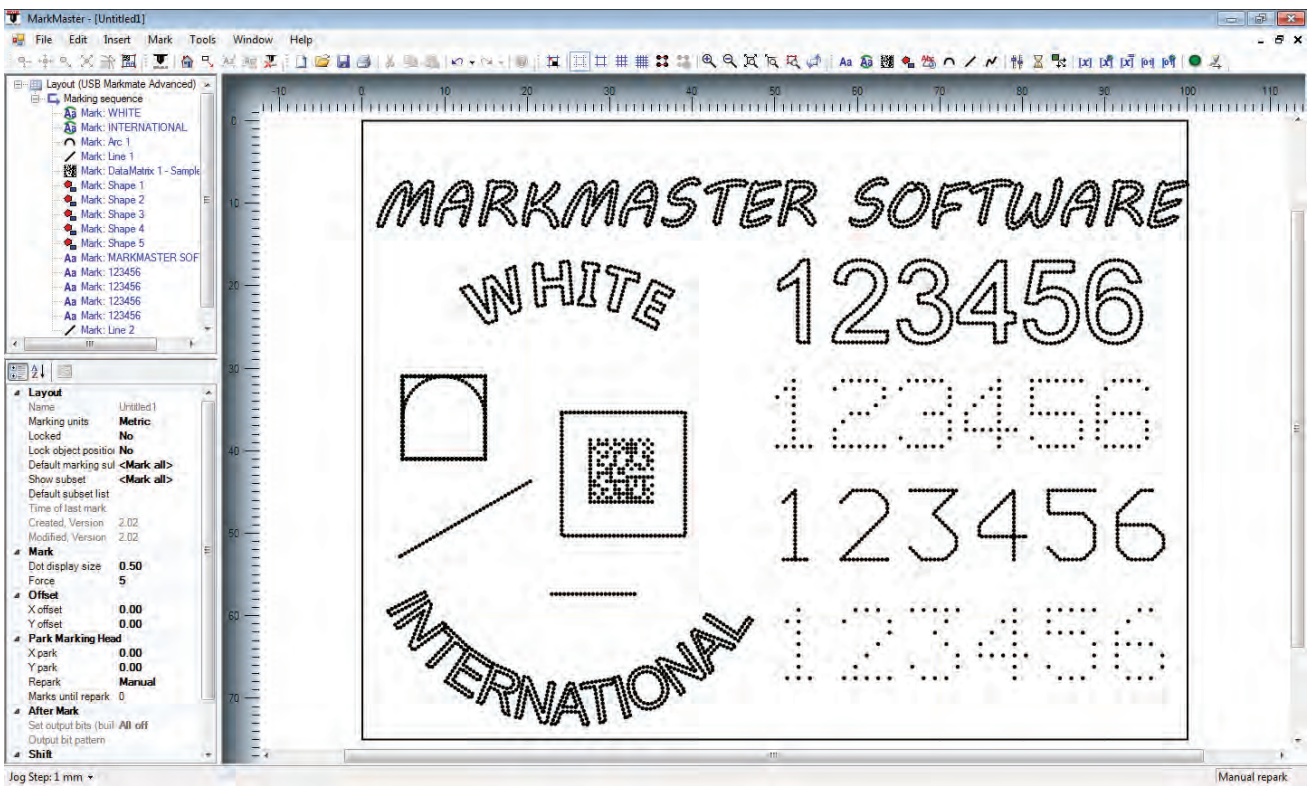

### NEW PELICAN CASE

Allows easy and safe transportation of your Markmate Machine.  
 Custom foam inserts ensure a perfect fit.  
 Wheels and pull handle to easily move the machine.  
 Item Code: 800453<sup>^</sup>



PART NO.	ITEM	DESCRIPTION	BARCODE	IMAGE
<b>MARKTRONIC PORTADOT SERIES</b>				
<p>Portable, programmable dot marking machines for use in applications where bringing the marking device to the work piece is a prerequisite. Uncompromising build quality and lightweight design ensure the PORTADOT series portable marking units are suitable for use in virtually any environment. Units are available with a variety of standard marking windows – 50mm x 25mm, 130mm x 30mm</p> <p><b>Applications Include:</b></p> <ul style="list-style-type: none"> <li>• 2D Data Matrix marking • Component traceability • Steel Stock marking • Serial numbering</li> <li>• Chassis marking • Time and date marking • Cast and forge marking • Batch and shift coding</li> <li>• Programmable marking • Part numbering • Component identification</li> </ul> <p><b>Technical Specification</b></p> <ul style="list-style-type: none"> <li>• Marking Area: 50mm x 25mm/130mm x 30mm</li> <li>• Std. Character Sizes: Model 50-25E 0.15mm – 24.99mm in increments of 0.15mm Model 130-30E 0.30mm – 99.99mm in increments of 0.15mm</li> <li>• Marking Formed: 5 x 7, 7 x 9, Varidot, 2D Data Matrix</li> <li>• Marking Speed: Extremely fast – 2 x 2.5mm characters per second</li> <li>• Memory Capacity: 1350 layouts</li> </ul> <p><b>Features:</b></p> <p><b>Portable and Powerful</b></p> <ul style="list-style-type: none"> <li>• Professional design for industrial applications - robust components enclosed in sturdy housing</li> <li>• Consistent deep permanent marking on all engineering materials and plastics to 62 HRC (800 Hy)</li> </ul> <p><b>Quiet, Fast, Efficient and Reliable Marking</b></p> <ul style="list-style-type: none"> <li>• No air supply required - runs on standard mains current</li> <li>• Highly efficient and significantly quieter than pneumatically actuated systems</li> <li>• The high torque motors and the lead-screw driven marking head guarantees dot precision unmatched on other portable systems</li> </ul> <p><b>Intelligent Software</b></p> <ul style="list-style-type: none"> <li>• The easy to use software allows for 4 standard font types and up to 1350 layouts to be stored</li> <li>• Easy programming and tool path preview (machine outlines the marking position on the part itself)</li> <li>• The multilingual user interface allows users to choose between different character fonts and type sizes as well as angular and arc marking, variable and serial numbers, date and time marking</li> <li>• 2D Data Matrix coding</li> </ul> <p><b>3000 Series Controller</b></p> <ul style="list-style-type: none"> <li>• No need for a PC. The controller is a separate unit to ensure it is protected from the mechanical shock loading during the marking operation</li> <li>• Very large and high contrast graphical screen ensures visuals at any angles</li> <li>• Full QWERTY membrane keyboard (possibility of external keyboard)</li> <li>• 2 x RS232 communication port</li> <li>• Digital I/O (8 Input, 6 Output)</li> <li>• Ethernet TCP/IP (optional)</li> </ul> <p><b>The machine comes with a 12 month manufacturer's warranty.</b></p>				
<b>PRYPORTADOT 50-25E</b>	<b>704356</b>	Portable, Separate Controller, Marking Area 50mm x 25mm		 PRYPORTADOT50-25E
<b>PRYPORTADOT 130-30E</b>	<b>711877</b>	Portable, Separate Controller, Marking Area 130mm x 30mm		 PRYPORTADOT50-25E with BASE
<b>PRYPORTADOT 100-75 EH</b>	<b>800605</b>	Portable Machine, Marking area 100mm x 75mm		 PRYPORTADOT130-30E
<b>ACCESSORIES AND SPARE PARTS</b>				
<b>PRYPORTABASE</b>	<b>704355</b>	Column and Base for PORTADOT 50-25E model		 PRYPORTADOT 100-75 EH
<b>PRYPORTABASE130-30E</b>	<b>800073</b>	Column and Base for PORTADOT 130-30E model		 3000 SERIES CONTROLLER
<b>PRYSTY4X50</b>	<b>704374</b>	Standard Stylus for PORTADOT Series 4mm x 50mm		
<b>PRYSTYSPRINGMM</b>	<b>704379</b>	Standard Stylus Spring for PORTADOT series		
<b>PRYNOS4X50</b>	<b>703952</b>	Standard Nose Piece for PORTADOT series		
<b>PRYBARCODEREADER</b>	<b>703590^</b>	Bar Code Reader for 3000 Series Controller		



## *DRILL CHUCKS*

# CLAMPING TECHNOLOGY

**RÖHM** is setting new standards in the production of all types of chucking tools from the smallest drill chuck to the most modern and high-tech special design. **RÖHM** products are designed by engineering specialists, who utilise the latest production equipment to manufacture and check the world's best chucking products. The **RÖHM** product range is unbeatable, and offer a custom design solution to meet your specific needs.







**RÖHM** see quality, precision, consulting and service as obligations.



## **SPECIALISING IN:**

*Drill Chucks • Chuck Adapters • Tailstock Centers • Lathe Chucks  
Precision & Machine Vices.*





PART NO.	ITEM	CAPACITY	KEY	MOUNT	BARCODE	IMAGE	
<b>EXTRA</b>							
For 240 volt electric or battery powered drills and screwdrivers up to 550 Watt capacity. Very ergonomical, easy to handle and equipped with a metal nose piece. Complete with through hole for reversible power tools. Packaged to suit Merchandiser stand.							
ROM1-664465	704529	1 - 10mm	keyless	3/8" x 24	4019208129334	Extra or Extra RV (Plastic Outer)	
ROM1-664466	704530	1.5 - 13mm	keyless	3/8" x 24	4019208129341		
ROM1-767554	704533	1.5 - 13mm	keyless	1/2" x 20	4019208150581		
<b>EXTRA RV</b>							
RV Chucks have a radial locking ratchet mechanism for impact / percussion drilling. This mechanism prevents drills coming loose in the drill chuck which is particularly useful when impact or percussion drilling. For 240 volt electric or battery powered drills and screwdrivers up to 1000 Watt capacity.							
13mm chucks have carbide inserts within the chuck jaws for greater gripping force. Very ergonomical, easy to handle and equipped with a metal nose piece. Complete with through hole for reversible power tools. Packaged to suit Merchandiser stand.							
ROM1-664467	704531	1 - 10mm	keyless	3/8" x 24	4019208129358	in all 13mm RV Chucks	
ROM1-767639	704535	1 - 10mm	keyless	1/2" x 20	4019208150666		
ROM1-767657	704537	1.5 - 13mm	keyless	3/8" x 24	4019208150697		
ROM1-767692	704539	1.5 - 13mm	keyless	1/2" x 20	4019208150765		
<b>EXTRA RV with Metal Outer Sleeve</b>							
This chuck has all the features of the Extra RV Chucks plus it has a Metal Outer Sleeve. Suitable for all drills up to 1100 Watt capacity. SUPERIOR GRIP with CARBIDE Inserts within the Jaws. Packaged to suit Merchandiser stand.							
ROM1-1033051	704485	1.5 - 13mm	keyless	3/8" x 24	4019208199238		
ROM1-802490	704542	1.5 - 13mm	keyless	1/2" x 20	4019208176932		
<b>SUPRA Type 138</b>							
All metal construction makes them suited to any capacity drill and the most rugged use by an operator. Rapid clamping and releasing of drill bits. Self tightening. These chucks are not suitable for impact drilling (Use Supra SK). Packaged to suit Merchandiser stand.							
ROM1-1015995	704482	Was ROM1-061684	0.5 - 10mm	keyless	3/8" x 24		4019208196022
ROM1-1014172	704481	Was ROM1-061689	1 - 13mm	keyless	3/8" x 24		4019208196725
ROM1-1033001	704483	Was ROM1-061691	1 - 13mm	keyless	1/2" x 20		4019208177212
<b>SUPRA SK Type 141</b>							
The strongest chucks for portable power tools. Quick action, self tightening keyless drill chuck for impact / percussion drilling. Automatic re-tightening in proportion to cutting force means that the clamping force is preserved even with the toughest jobs.							
The safety lock prevents the chuck from opening even when subjected to the highest vibration and impact frequencies. The chucks are sealed against swarf and dirt. Only ROM1-249804 is packaged to suit the merchandiser stand. * = ROM1-863921 has an additional thread lock for reversible power tools.							
ROM1-249804	704504		1 - 13mm	keyless	1/2" x 20		4019208067704
ROM1-863921	704544		1 - 13mm *	keyless	1/2" x 20*	4019208178455	
<b>SUPRA Type 136</b>							
Heavy duty industrial design for stationary drilling machines. Rapid clamping and releasing of drill bits. Self tightening during operation. High concentricity for accurate drilling. Spare parts available.							
ROM1-871044	704563	Was 020159	0 - 10mm	keyless	3/8" x 24		4019208189802
ROM1-871052	704568	Was 020105	1 - 13mm	keyless	J2		4019208189833
ROM1-871054	704569	Was 020113	1 - 13mm	keyless	J6		4019208189857
ROM1-871055	704570	Was 020167	1 - 13mm	keyless	1/2" x 20		4019208189871
ROM1-871066	704578	Was 020121	3 - 16mm	keyless	J6		4019208192512



PART NO.	ITEM	CAPACITY	KEY	MOUNT	BARCODE	IMAGE	
<b>SPIRO Type 134</b>							
<p>The highest precision keyless drill chuck available. All parts subject to wear are hardened and ground. They have the best concentricity possible, with a runout of less than 0.05mm.</p> <p>We also have 4mm, 6.5mm, and 8mm capacity chucks available. Also available are the Spiro SK series, that are suitable for high speed machining centres due to their locking mechanism.</p>							
<b>ROM1-871015</b>	<b>704547</b>	Was 019953	1 - 13mm	keyless	J6		4019208192710
<b>ROM1-871018</b>	<b>704548</b>	Was 019961	3 - 16mm	keyless	J6		4019208208381
<b>PRIMA Type 116</b>							
<p>Keyed Chuck for all portable power tools and hand operated drilling machines. Suitable for impact/ percussion drilling, although we do recommend the Prima - Mat range for the tough jobs. Packaged to suit Merchandiser stand. * = with through hole for reversible power tools.</p>							
<b>ROM1-636614</b>	<b>704528</b>		1 - 10mm*	S2	3/8" x 24*		4019208177236
<b>ROM1-061671</b>	<b>704448</b>		1 - 10mm	S2	1/2" x 20		4019208176482
<b>ROM1-082371</b>	<b>704479</b>		1.5 - 13mm	S2	3/8" x 24		4019208178462
<b>ROM1-381547</b>	<b>704525</b>		1.5 - 13mm*	S2	1/2" x 20*		4019208177229
<b>PRIMA BALL BEARING KEYED CHUCKS</b>							
<p>Designed for the Extra Heavy Duty jobs and manufactured to the highest precision to ensure the best concentricity available.</p>							
<b>ROM1-215000</b>	<b>704487</b>		1 - 13mm	S10	J3		4019208227955
<b>ROM1-215001</b>	<b>704488</b>		1 - 16mm	S10	J3		4019208227962
<b>PRIMA Type 111</b>							
<p>Heavy Duty Industrial designed keyed chuck for stationary drilling and hand operated percussion drilling machines. High concentricity for accurate drilling. All parts subject to wear are hardened and ground. The keyholes are hardened and the chucks are all steel construction. * = with through hole for reversible power tools.</p>							
<b>ROM1-072811</b>	<b>704461</b>		0.5 - 6.5mm	S1	3/8" x 24		4019208018133
<b>ROM1-072628</b>	<b>704454</b>		0.5 - 8mm	S2	3/8" x 24		4019208018027
<b>ROM1-317257</b>	<b>704520</b>		1.5 - 13mm	S2	1/2" x 20*		4019208078205
<b>ROM1-072815</b>	<b>704463</b>		1 - 13mm	S3	B16		4019208018157
<b>ROM1-072818</b>	<b>704464</b>		1 - 13mm	S3	J6		4019208018164
<b>ROM1-227152</b>	<b>704492</b>		3 - 16mm	S3	B16		4019208062747
<b>ROM1-072827</b>	<b>704469</b>		1 - 16mm	S3	J3		4019208018218
<b>ROM1-072828</b>	<b>704470</b>		1 - 16mm	S3	J6		4019208018225
<b>ROM1-072829</b>	<b>704471</b>		1 - 16mm	S3	5/8" x 16		4019208018232

**\*\*Please note that other types of RöhM Chucks are available upon request.\*\***

PART NO.	ITEM	CAPACITY	KEY	MOUNT	BARCODE	IMAGE
<b>DRILL DRIFTS</b>						
ROM1-017076	704441	MT 1 & 2			4019208002637	
ROM1-017077	704442	MT 3			4019208002644	
ROM1-017078	704443	MT 4			4019208002651	
ROM1-017079	704444	MT 5 & 6			4019208002668	

<b>CHUCK KEYS</b>						
Part No.		Keysize	Description			
ROM1-026411	704447	S1			4019208012759	
ROM1-205989	704486	S2			4019208056821	
ROM1-309380	704514	S2 AT	Suits 13mm Prima Mat		4019208069296	
ROM1-025835	704445	S3			4019208012315	
ROM1-025839	704446	S4			4019208012322	
ROM1-068006	704451	S10	Same as K3 Jacobs		4019208228921	

<b>REDUCING SLEEVES</b>						
^ = non stocked lines		Outer Morse Taper	Inner Morse Taper	Dimension "L"		
ROM1-017003	704424^	MT 2	MT 1	92mm	4019208002071	
ROM1-017004	704425^	MT 3	MT 2	112mm	4019208002088	
ROM1-017007	704428^	MT 4	MT 3	140mm	4019208002118	
ROM1-017006	704427^	MT 4	MT 2	124mm	4019208002101	
ROM1-017005	704426^	MT 4	MT 1	124mm	4019208002095	

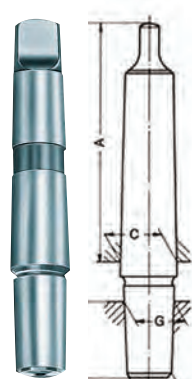
<b>ARBORS</b>						
Part No.		Morse Taper	Drill Chuck Mount	Dim. "C"	Dim. "G"	
ROM1-014981	704410	MT 2	J6	17.780	17.170	 <p>Morse Taper end</p> <p>Drill Chuck Mount end. This must match the Drill Chuck Mount.</p>
ROM1-014980	704409	MT 2	J33	17.780	15.850	
ROM1-014984	704412	MT 3	J3	23.825	20.599	
ROM1-014988	704416	MT 3	J6	23.825	17.170	
ROM1-014991	704417	MT 4	J3	31.267	20.599	
ROM1-014995	704419	MT 4	J6	31.267	17.170	

**LATHE CHUCKS**

Rohm's Geared Scroll Chuck is a proven design for universal use. The chuck body is made from a special grade of Cast Iron for life long performance. The scroll is drop forged and balanced, hardened with the thread flanks ground on both sides. Each chuck comes with a set of inside jaws and a set of outside jaws that are hardened and ground. You'll pay a bit more for a Rohm chuck, but it's performance, concentricity and repeatability is second to none.

**Contact Customer Service For Lathe Chucks**

- Rohm also manufacture:
- Higher Precision Live centres
  - Carbide tipped Live centres
  - Live centres with Draw-off Nut,
  - Various types of live centre for high speed work,
  - Live centres with Pressure Display
  - Live centres for Very Heavy-Duty machining (workpieces up to 20,000kg)
  - Constant face Drivers, Dead Centres.
  - 4 Jaw Independent and self centering chucks and Machine Vices etc.
- More detailed information can be found at [www.roehm.biz/en/home](http://www.roehm.biz/en/home)

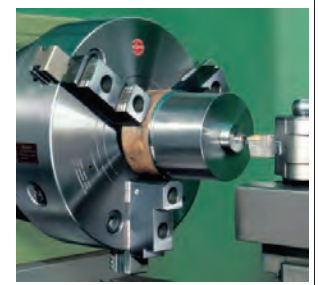



**WHITE**  
INTERNATIONAL

**TOOL STORAGE**  
*Quality • Strength • Security*

# COMPLETE SOLUTIONS

*Tool Chests*

*Roller Cabinets*

*Side Lockers*

*Hand Boxes*

*Utility Carts*

*Truck Boxes*

*Site Boxes*

*Shelving*





*Cabinets*







**TERMS AND CONDITIONS**





*(Subject to the provisions of the Trade Practices Act and Goods and Consumer Protection Legislation of various states)*

*White International Pty Ltd warrants that the toolboxes we distribute are free from manufacturers defect in workmanship and materials, for 12 months from the date of purchase. Subject to the conditions of the warranty White International will replace part/s and or item free of charge. This warranty excludes any product defects due to neglect, abuse or misuse of the product. None of our toolboxes are warranted for use in mobile vehicle situations except for our truck boxes. White International toolboxes are not designed to be used on uneven surfaces. White International toolboxes left in direct sunlight may be prone to fading. Our warranty commences from the date of purchase and is not transferable. The warranty only covers the original owner, purchaser or end user and is subject to the Trade Practices Act and Goods and Consumer Protection legislation of the various states. Proof of purchase along with appropriate documentation is required before consideration under warranty is given.*

PART NO.	ITEM	DESCRIPTION	BARCODE	IMAGE
<b>BALL BEARING TOOL CHESTS</b>				
<b>TOOL CHESTS</b>				
<ul style="list-style-type: none"> <li>• Heavy gauge sheet steel</li> <li>• Fully extendable drawers</li> <li>• Includes drawer liners</li> <li>• Full length Piano Hinges</li> <li>• Tough Industrial Powder coating</li> <li>• Aluminium drawer handles / Moulded side handle</li> <li>• Double walled fabrication</li> <li>• Snap-lock drawers</li> <li>• Rolled edge construction</li> </ul>				
WHI503B	710746	<b>TOOL CHEST 6 DRAWER BALL BEARING SLIDES and lockable drop front</b> 660W X 310D X 370H (mm) Gross Weight: 26.1 kg Net Weight: 24.1 kg Internal drawer measurements 3 Drawers: 171Wx265Dx45H (mm) 2 Drawers: 575Wx265Dx45H (mm) 1 Drawer: 575Wx265Dx62H (mm) 1 Tray: 520Wx210Dx45H (mm) • 10" Ball bearing slides • Double lid support	9312198830675	
WHI508B	710750	<b>TOOL CHEST 8 DRAWER BALL BEARING SLIDES and lockable drop front - LARGE SIZE 8 DRAWER</b> 660W X 360D X 420H (mm) Gross Weight: 32.8 kg Net Weight: 30.6 kg Internal drawer measurements 6 Drawers: 172Wx320Dx45H (mm) 1 Drawer: 575Wx320Dx45H (mm) 1 Drawer: 575Wx320Dx115H (mm) 1 Tray: 520Wx210Dx45H (mm) • 12" Ball bearing slides • Double lid support	9312198854503	
WHI509B	710752	<b>TOOL CHEST 9 DRAWER BALL BEARING SLIDES and lockable drop front</b> 660W X 360D X 420H (mm) Gross Weight: 36 kg Net Weight: 34 kg Internal drawer measurements 6 Drawers: 172Wx320Dx45H (mm) 2 Drawers: 575Wx320Dx45H (mm) 1 Drawer: 575Wx320Dx62H (mm) 1 Tray: 520Wx210Dx45H (mm) • 12" Ball bearing slides • Double lid support	9312198831665	
WHI510B	710753	<b>TOOL CHEST 11 DRAWER BALL BEARING SLIDES and lockable drop front</b> 660W X 460D X 520H (mm) Gross Weight: 52.0 kg Net Weight: 47.8 kg Internal drawer measurements 7 Drawers: 172Wx408Dx48H (mm) 1 Drawer: 172Wx408Dx103H (mm) 2 Drawers: 575Wx408Dx48H (mm) 1 Drawer: 575Wx408Dx95H (mm) 1 Tray: 520Wx210Dx45H (mm) • 14" Ball bearing slides • Gas Struts	9312198830699	

PART NO.	ITEM	DESCRIPTION	BARCODE	IMAGE
WHI514B	710754	<b>TOOL CHEST 14 DRAWER BALL BEARING SLIDES</b> 1030W X 440D X 590H (mm) Gross Weight:76.0 kg Net Weight: 65.5kg Internal drawer measurements 9 Drawers left 170Wx348Dx45H (mm) 2 Drawers left 575Wx348Dx45H (mm) 1 Drawer left 575Wx348Dx62H (mm) 2 Drawers right 315Wx348Dx140H (mm) • 14" Ball bearing slides • Gas Struts	9312198832297	
WHIC56-9B	710801	<b>TOOL CHEST 9 DRAWER BALL BEARING TOP GUN to suit WHI880B</b> 1410W X 610D X 490H (mm) Gross Weight:121.0 kg Net Weight: 105.0 kg Internal drawer measurements 4 Drawers left 630Wx550Dx45H (mm) 1 Drawer left 630Wx550Dx110H (mm) 3 Drawers right 630Wx550Dx45H (mm) 1 Drawer right 630Wx550Dx160H (mm) • 20" Ball bearing slides • Gas Struts	9312198847284	
<b>TOOL CHEST ADD-ONS</b> • Heavy gauge sheet steel • Tough Industrial Powder coating • Fully extendable drawers • Aluminium drawer handles / Moulded side handle • Includes drawer liners & top mat • Double walled fabrication • Rolled edge construction • Snap-lock drawers				
WHI505B	710748	<b>TOOL CHEST 2 DRAWER BALL BEARING ADD-ON To suit 491B, 496B, 499B, 502B, 503B &amp; 504B</b> 691W X 320D X 300H (mm) Gross Weight: 13.8 kg Nett Weight: 12.1 kg Internal drawer measurement Drawers: 575Wx273Dx100H (mm) • 10" Ball bearing slides	9312198830705	
WHI507B	710749	<b>TOOL CHEST 3 DRAWER BALL BEARING ADD-ON To suit 491B, 496B, 499B, 509B &amp; 510B</b> 670W X 450D X 250H (mm) Gross Weight: 19.5 kg Net Weight: 17.7 kg Internal drawer measurements 2 Drawers: 575Wx408Dx48H (mm) 1 Drawers: 575Wx408Dx62H (mm) • 14" Ball bearing slides	9312198842159	

PART NO.	ITEM	DESCRIPTION	BARCODE	IMAGE
<b>HAND BOXES</b>				
WHIT400DR	800108	<b>TOOL BOX DIAMOND PLATE RED</b> 400W X 170D X 190H (mm) Gross Weight: 1.2 kg Net Weight: 0.9 kg <ul style="list-style-type: none"> <li>• Tough Powder coating finish</li> <li>• Steel reversed triangular cross bar carry handle</li> </ul>	9312198856040	
WHI620	710756	<b>TOOL BOX WITH TOTE TRAY</b> 510W X 250D X 250H (mm) Gross Weight: 6.5 kg Net Weight: 5.5 kg Internal drawer measurement Tote tray: 478Wx233Dx45H (mm) <ul style="list-style-type: none"> <li>• Heavy gauge sheet steel</li> <li>• Tough Industrial Powder coating</li> <li>• Reinforced Lid / With Lift-out Tray</li> <li>• Chrome Plated Hasp &amp; Staple except padlock</li> </ul>	9312198848045	
WHI621	710757	<b>TOOL BOX CANTILEVER 5 TRAY</b> 540W X 200D X 210H (mm) Gross Weight: 5.7 kg Net Weight: 5.1 kg <ul style="list-style-type: none"> <li>• Heavy gauge sheet steel</li> <li>• Tough Industrial Powder coating</li> <li>• Feature based compartment plus four cantilever shelves</li> </ul>	9312198831429	
WHITB200	800042	<b>TOOL BOX CANTILEVER 3 TRAY</b> 460W X 208D X 198H (mm) Gross Weight: 7.1 kg (pack of 2) Net Weight: 3.0 kg (ea) <ul style="list-style-type: none"> <li>• Heavy duty carry handle</li> <li>• Tough Powder coating finish</li> <li>• Security latch for padlocking</li> <li>• Sold in packs of 2</li> </ul>	9312198856170	
WHITB500	800043	<b>TOOL BOX CANTILEVER 5 TRAY</b> 460W X 205D X 260H (mm) Gross Weight: 9.8 kg (pack of 2) Net Weight: 4.2 kg (ea) <ul style="list-style-type: none"> <li>• Heavy duty carry handle</li> <li>• Tough Powder coating finish</li> <li>• Security latch for padlocking</li> <li>• Sold in packs of 2</li> </ul>	9312198856187	
WHITB100	800041	<b>TOOL BOX HANDY RED TOOL BOX</b> 385W X 160D X 140H (mm) Gross Weight: 2.9 kg (pack of 2) Net Weight: 1.3 kg (ea) <ul style="list-style-type: none"> <li>• Heavy duty carry handle</li> <li>• Tough Powder coating finish</li> <li>• Security latch for padlocking</li> <li>• Sold in packs of 2</li> </ul>	9312198856088	

PART NO.	ITEM	DESCRIPTION	BARCODE	IMAGE
<b>BALL BEARING ROLLER CABINETS</b>				
<b>ROLLER CABINETS</b>				
<ul style="list-style-type: none"> <li>• Heavy gauge sheet steel</li> <li>• Tough Industrial Powder coating</li> <li>• Aluminium drawer handles for easy grip</li> <li>• Includes drawer liners</li> <li>• Includes top mat</li> <li>• Fully extendable drawers</li> <li>• Snap-lock drawers</li> <li>• Double walled fabrication</li> <li>• Rolled edge construction</li> </ul>				
WHI491B	710742	<b>ROLLER CABINET 7 DRAWER BALL BEARING SLIDES</b> 675W X 460D X 910H (mm) Gross Weight: 57.5 kg Weight: 54.8 kg Internal drawer measurements 4 Drawers: 581Wx403Dx45H (mm) 3 Drawers: 581Wx403Dx100H (mm) <ul style="list-style-type: none"> <li>• 16" Ball bearing slides</li> <li>• Includes lockable drop front for security.</li> <li>• Complete with 125KG castors -2 fixed and 2 swivel castors with brakes</li> </ul>	9312198830712	
WHI496B	710743	<b>ROLLER CABINET 11 DRAWER BALL BEARING SLIDES</b> 680W X 460D X 1070H (mm) Gross Weight: 77.5 kg Net Weight: 74.0 kg Internal drawer measurements 4 Drawers: 274Wx402Dx45H (mm) 4 Drawers: 582Wx402Dx45H (mm) 2 Drawers: 582Wx402Dx100H (mm) 1 Drawer: 582Wx402Dx150H (mm) <ul style="list-style-type: none"> <li>• 16" Ball bearing slides</li> <li>• Includes lockable drop front for security.</li> <li>• 250kg heavy duty castors</li> </ul>	9312198830729	
WHI753B	710758	<b>ROLLER CABINET 16 DRAWER BALL BEARING SLIDES</b> 1040W X 460D X 1020H (mm) Gross Weight: 120.10 kg Net Weight: 107.90 kg Internal drawer measurements 5 Drawers left: 580Wx402Dx45H (mm) 5 Drawers right: 302Wx402Dx45H (mm) 2 Drawers left: 580Wx402Dx100H (mm) 1 Drawer left: 580Wx402Dx150H (mm) 2 Drawers right: 302Wx402Dx100H (mm) 1 Drawer right: 302Wx402Dx150H (mm) <ul style="list-style-type: none"> <li>• 16" Ball bearing slides</li> <li>• Includes lockable drop fronts for security.</li> <li>• Complete with heavy duty 250kg castors, 2 fixed and 2 swivel castors with brakes</li> </ul>	9312198831405	
WHI880B	710760	<b>LONGREACH ROLLER CABINET 13 DRAWER BALL BEARING SLIDES</b> 1430W X 620D X 1000H (mm) Gross Weight: 187.0 kg Net Weight: 169.0 kg Internal drawer measurements 1 Drawer: 1302Wx530Dx90H (mm) 10 Drawers: 625Wx530Dx60H (mm) 2 Drawers: 625Wx530Dx125H (mm) <ul style="list-style-type: none"> <li>• 20" Ball bearing slides</li> <li>• Complete with heavy duty 250kg castors, 2 fixed and 2 swivel castors with brakes</li> </ul>	9312198842104	

PART NO.	ITEM	DESCRIPTION	BARCODE	IMAGE
<b>SIDE LOCKERS</b>				
<ul style="list-style-type: none"> <li>• Heavy gauge sheet steel</li> <li>• Tough Industrial Powder coating</li> <li>• Aluminium drawer handles</li> <li>• Includes drawer liners</li> <li>• Snap-lock drawers</li> <li>• Double walled fabrication</li> <li>• Rolled edge construction</li> </ul>				
WHISL-402	710847	<b>SIDE LOCKER 2 DRAWER SUITS 753B</b> To suit WHI753B can also be used as add-on for WHI496B 360W X 460D X 850H (mm) Gross Weight: 25.0 kg Net Weight: 23.0 kg Internal drawer measurement 2 Drawers 250Wx370Dx60H (mm) • 14" Ball bearing slides	9312198847307	
WHISL-408	710848	<b>SIDE LOCKER 8 DRAWER SUITS 753B</b> To suit WHI753B can also be used as add-on for WHI496B 360W X 460D X 850H (mm) Gross Weight: 38.1 kg Net Weight: 35.6 kg Internal drawer measurements 1 Drawer 255Wx370Dx75H (mm) 6 Drawers 255Wx370Dx55H (mm) 1 Drawer 255Wx370Dx130H (mm) • 14" Ball bearing slides	9312198847314	
WHI518	710755	<b>SIDE SHELF</b> To suit 491B, 496B, 499B & 753B Roll Cabs 470W X 360D X 40H (mm) Gross Weight: 3.6 kg Net Weight: 3.4 kg 465Wx362Dx41H (mm) • Heavy gauge sheet steel	9312198831368	
<b>TROLLEY</b>				
WHIT700B	710850	<b>TROLLEY 3 TIER W BALL BEARING DRAWER</b> 720W X 420D X 910H (mm) Gross Weight: 26.7 kg Net Weight: 25.6 kg Internal drawer measurement 1 Drawer: 566Wx268Dx65H (mm) • Heavy gauge sheet steel • Tough Industrial Powder coating • Feature 2 based compartment for easy access • 10" Ball Bearing Drawer Slides • Including top mat & draw liner	9312198831412	











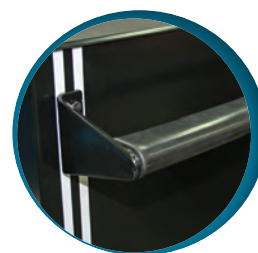

PART NO.	ITEM	DESCRIPTION	BARCODE	IMAGE
<b>PRO SERIES</b>				
<b>TOOL CHESTS</b>				
<ul style="list-style-type: none"> <li>• Black economy version tool chest</li> <li>• Tough Industrial Powder coating</li> <li>• Fully extendable drawers with ball bearing slides</li> <li>• Aluminum drawer handles</li> <li>• Moulded side handles</li> <li>• Includes drawer liners</li> <li>• Double walled fabrication</li> <li>• Rolled edge construction</li> </ul>				
WHIPTC106	710823	<b>PRO SERIES - 9 DRAWER TOOL CHEST BALL BEARING SLIDES</b> 660W X 305D X 420H (mm) Gross Weight: 28.0 kg Net Weight: 26.4 kg Internal drawer measurements 1 Drawer: 575Wx265Dx66H (mm) 2 Drawers: 575Wx265Dx51H (mm) 6 Drawers: 170Wx265Dx51H (mm) 1 Tray: 440Wx180Dx82H (mm)  Updated look due to arrive late 2014.	9312198855104	
<b>ROLLER CABINET</b>				
WHIPMT111	710817	<b>PRO SERIES - 7 DRAWER ROLLER CABINET BALL BEARING SLIDES</b> 685W X 465D X 955H (mm) Gross Weight: 53.0 kg Net Weight: 49.0 kg Internal drawer measurements 2 Drawers: 584Wx380Dx153H (mm) 5 Drawers: 584Wx380Dx74H (mm) <ul style="list-style-type: none"> <li>• Black economy version roller cabinet</li> <li>• Heavy gauge sheet steel</li> <li>• Tough Industrial Powder coating</li> <li>• Chrome plated tube side handle</li> <li>• Ball bearing slides</li> <li>• Aluminium drawer handles for easy grip</li> <li>• Includes drawer liners and top mat</li> <li>• Complete with 125kg castors - 2 fixed and 2 swivel castors with brakes.</li> </ul> Updated look due to arrive late 2014.	9312198855111	



**PRO SERIES - New look arriving late 2014**

- New look ABS handles
- Updated chrome castors
- ABS side handle



PART NO.	ITEM	DESCRIPTION	BARCODE	IMAGE
<b>SHELVING UNITS</b>				
WHIPCRE604B	800036	<b>SHELVING UNIT 4 SHELF BLACK 60KG</b> 710W X 300D X 1370H (mm) Gross Weight: 5.4 kg Net Weight: 5.0 kg <ul style="list-style-type: none"> <li>• Tough industrial powder coating</li> <li>• Rolled edging for non cut safety &amp; strength</li> <li>• Assembly with nuts &amp; bolts for a fixed joint</li> <li>• Comes in colour carton</li> <li>• Product on shelving not included</li> </ul>	9312198856194	 
WHIPCRE1754	800037	<b>SHELVING UNIT 4 SHELF BLACK 175KG</b> 820W X 320D X 1500H (mm) Gross Weight: 13.7 kg Net Weight: 13.1 kg <ul style="list-style-type: none"> <li>• Tough industrial powder coating</li> <li>• Rolled edging for non cut safety &amp; strength</li> <li>• 9mm MDF laminated board shelving</li> <li>• Simply assembles with a hammer, no nuts or bolts</li> <li>• Comes in colour carton</li> <li>• Product on shelving not included</li> </ul>	9312198856200	 
WHIPCRE3003	800038	<b>SHELVING UNIT 3 SHELF 300KG WORKBENCH</b> 1158W X 567D X 914H (mm) Gross Weight: 25.0 kg Net Weight: 24.0 kg <ul style="list-style-type: none"> <li>• Tough industrial powder coating</li> <li>• Rolled edging for non cut safety &amp; strength</li> <li>• 15mm MDF board benchtop</li> <li>• 12mm MDF board shelving</li> <li>• Simply assembles with a hammer, no nuts or bolts</li> <li>• Product on shelving not included</li> </ul>	9312198856026	 
WHIPCRE4005	800039	<b>SHELVING UNIT 5 SHELF 400KG</b> 910W X 408D X 1800H (mm) Gross Weight: 26.4 kg Net Weight: 25.3 kg <ul style="list-style-type: none"> <li>• Tough industrial powder coating</li> <li>• Rolled edging for non cut safety &amp; strength</li> <li>• 12mm MDF laminated board shelving</li> <li>• Simply assembles with a hammer, no nuts or bolts</li> <li>• Comes in colour carton</li> <li>• Product on shelving not included</li> </ul>	9312198856019	 
<b>STORAGE CABINET</b>				
WHISC6600	800047	<b>STORAGE CABINET GREY HAMMER 1.68M</b> 762W X 381D X 1680H (mm) Gross Weight: 33.1 kg Net Weight: 30.0 kg <ul style="list-style-type: none"> <li>• Tough industrial powder coating</li> <li>• Knock down style</li> <li>• Bolts / nuts design</li> <li>• 3 shelves - adjustable</li> <li>• 3 point locking system for added security</li> <li>• Product on shelving not included</li> </ul>	9312198856033	 

PART NO.	ITEM	DESCRIPTION	BARCODE	IMAGE
<b>SITE BOXES</b>				
<ul style="list-style-type: none"> <li>• Tough industrial powder coating</li> <li>• Full welding for maximum strength</li> <li>• Recessed steel powder coated tube side handles</li> <li>• Recessed locking area protects contents</li> <li>• 2 full length metal feet</li> <li>• Full length piano hinge</li> <li>• Heavy gauge sheet steel</li> <li>• Now with gas struts</li> </ul>				
WHISB445	710830	<b>SITE BOX 445</b> 812W X 483D X 445H (mm) Gross Weight: 32.0 kg Net Weight: 30.5 kg	9312198855173	
WHISB565	710831	<b>SITE BOX 565</b> 1067W X 508D X 595H (mm) Gross Weight: 48.2 kg Net Weight: 45.8 kg	9312198855180	
WHISB700	710832	<b>SITE BOX 700</b> 1219W X 610D X 700H (mm) Gross Weight: 67.4 kg Net Weight: 64.4 kg	9312198855197	
WHISB850	710834	<b>SITE BOX 850</b> 1219W X 762D X 850H (mm) Gross Weight: 83.6 kg Net Weight: 79.7 kg	9312198855203	
WHISB-CASTORSET	800457	<b>CASTOR SET</b> <ul style="list-style-type: none"> <li>• To suit above heavy duty site boxes</li> <li>• Set contains 2 fixed and 2 swivel castors with brakes</li> </ul>	9313213002541	

PART NO.	ITEM	DESCRIPTION	BARCODE	IMAGE
<b>TRUCK BOXES</b>				
<b>PROFESSIONAL SERIES</b>				
<ul style="list-style-type: none"> <li>• Heavy gauge sheet steel</li> <li>• Heavy duty Silver/Grey powder coating with UV protection</li> <li>• Checker plate finish</li> <li>• Strong reinforced lid</li> <li>• Aluminium handles / metal badge</li> </ul>				
WHITB10C	710851	<b>TRUCK BOX PRO 10C</b> 550W X 260D X 220H (mm) Gross Weight: 7.2 kg Net Weight: 6.2 kg • Full length piano hinge / 2 1/2" lock hasp staple • Metal hinge lid stay	9312198842722	
WHITB20C	710853	<b>TRUCK BOX PRO 20C</b> 770W X 340D X 260H (mm) Gross Weight: 15.0 kg Net Weight: 13.3 kg • Full length piano hinge 4 1/4" lock hasp staple • Metal hinge lid stay	9312198842739	
WHITB30C	710856	<b>TRUCK BOX PRO 30C</b> 1256W X 390D X 380H (mm) Gross Weight: 35.0 kg Net Weight: 33.0 kg • Stainless Steel lock • One pair of gas struts	9312198842746	
WHITB40C	710858	<b>TRUCK BOX PRO 40C</b> 1380W X 500D X 440H (mm) Gross Weight: 48.5 kg Net Weight: 44.5 kg • Stainless Steel lock • One pair of gas struts	9312198842753	
<b>UPRIGHT</b>				
<ul style="list-style-type: none"> <li>• Tough industrial powder coating</li> <li>• Diamond plate finish</li> <li>• Lid reinforcer protects from forced entry</li> <li>• Gas struts for lid support</li> </ul>				
WHIUPTB900	800049	<b>TRUCK BOX UPRIGHT</b> 900W X 500D X 700H (mm) Gross Weight: 32.0 kg Net Weight: 29.3 kg • 1 shelf for added storage • 1 x stainless steel lock	9312198856095	 <div style="position: absolute; top: 10px; left: 10px; background-color: #0070C0; color: white; border-radius: 50%; padding: 5px; font-weight: bold;">NEW</div>
WHIUPTB1220R	710862	<b>TRUCK BOX UPRIGHT</b> 1220W X 500D X 700H (mm) Gross Weight: 42.0 kg Net Weight: 38.0 kg • 2 shelves for added storage • 2 off stainless steel locks with recessed lock handles	9312198855166	

PART NO.	ITEM	DESCRIPTION	BARCODE	IMAGE
<b>HANDY SERIES</b>				
<ul style="list-style-type: none"> <li>• Tough industrial powder coating</li> <li>• Diamond plate finish</li> <li>• Lid reinforcer protects from forced entry</li> <li>• Locking hasp and staple</li> <li>• Powder coated steel side handles</li> </ul>				
WHITB10D	710852	<b>TRUCK BOX HANDY 10D</b> 553W X 226D X 217H (mm) Gross Weight: 4.4 kg Net Weight: 3.8 kg • 2 pcs of 2" piano hinges	9312198855128	
WHITB20D	710855	<b>TRUCK BOX HANDY 20D</b> 777W X 344D X 257H (mm) Gross Weight: 8.4 kg Net Weight: 7.2 kg • 2 pcs of 2" piano hinges	9312198855135	
WHITB30D	710857	<b>TRUCK BOX HANDY 30D</b> 1152W X 388D X 384H (mm) Gross Weight: 16.2 kg Net Weight: 14.3 kg • 2 pcs of 3" piano hinges	9312198855142	
WHITB40D	710859	<b>TRUCK BOX HANDY 40D</b> 1383W X 494D X 440H (mm) Gross Weight: 24.1 kg Net Weight: 21.5 kg • 2 pcs of 3" piano hinges	9312198855159	
<b>HANDY SERIES - GALVANISED</b>				
WHITB30DG20DG	800040	<b>TRUCK BOX TWIN PACK 30D + 20D GALVANISED</b> Total Gross Weight: 22.7 kg Total Net Weight: 20.6  <b>20DG:</b> 777W X 360D X 257H (mm) • 2 pcs of 2" piano hinges  <b>30DG:</b> 1152W X 388D X 384H (mm) • 2 pcs of 3" piano hinges	9312198856071	 

PART NO.	ITEM	DESCRIPTION	BARCODE	IMAGE
<b>TOOL STORAGE SPARE PARTS</b>				
<b>LOCKS &amp; KEYS</b>				
WHIBL505B	800488	Double sided with plastic mould to suit: WHIPMT111		 WHIBL500  WHITL10/20C  WHITL30/40C
WHIBL500B	800489	Double sided with plastic mould to suit: WHIPTC105		
WHIBL900B	800490	Double sided with plastic mould to suit: WHIPTC106		
WHIBLUPTB1220R	800491	Double sided with plastic mould to suit: WHIUPTB1220R/900		
WHIBL800	710784	Double sided with plastic mould to suit: WHI408B/505B/507B/880B		
WHIBL400	710779	Double sided with plastic mould to suit: WHI499B/491B/496B/753B		
WHIBL500	710780	Double sided with plastic mould to suit: WHI504/503/502/509/510		
WHIBL505	710781	Double sided with plastic mould to suit: WHI505/507/WHI880/WHISL408		
WHIBL600	710782	Double sided with plastic mould to suit: WHI514		
WHIBL700	710783	Double sided with plastic mould to suit: WHISL402		
WHITL10/20C	710860	To suit: WHITB10C/20C		
WHITL30/40C	710861	To suit: WHITB30C/40C		
<b>SLIDES</b>				
WHIBSLIDE10B	800486	10" (254mm) WHIPTC105/106		 WHIBSLIDE10
WHIBSLIDE14B	800487	14" (356mm) WHIPMT111		
WHIBSLIDE10	710792	10" (254mm) WHI504/503/502/505/700		
WHIBSLIDE12	710793	12" (300mm) WHI509		
WHI510BP-BS	710794	14" (356mm) WHI510/514/507 WHISL402/408		
WHIBSLIDE16	710796	16" (400mm) WHI499/491/496/753		
WHIBSLIDE20	710797	20" (500mm) WHI880/WHIC56-9/WHISL507		
<b>CASTORS</b>				
WHIBFC111	800493	fixed to suit WHIPMT111		 WHICSPARE SWIVEL
WHIBSC111	800492	swivel to suit WHIPMT111		
WHIBFC500D	710772	fixed 125 kg WHI499/491		
WHIBSC500D	710788	swivel 125 kg WHI499/491		
WHIBFC753	710773	fixed 250 kg WHI880/753/496		
WHIBSC880	710789	swivel 250 kg WHI880 with brake		
WHIBSCM880	710790	swivel 250 kg WHI880 middle castor no brake		
WHIBSC500	710787	swivel 250 kg WHI753/496		
WHICSPARE SWIVEL	710808	swivel 250 kg with brake		
<b>SIDE HANDLES</b>				
WHISH880	710835	Chrome plated 590mm oval tube shape to suit: WHI880		 WHISHROLLCAB
WHISHROLLCAB	710836	Chrome plated oval tube shape 440mm to suit: WHI499/491/496/753		

# INDEX - Item Code

500001	5	500136	7	502151	39	502263	29	503506	216	503636	182	503710	174	503793	176
500002	5	500137	7	502152	36	502264	29	503507	216	503637	182	503711	174	503794	176
500003	5	500138	7	502153	39	502265	29	503568	132	503638	182	503712	174	503795	176
500004	5	500148	7	502154	39	502266	29	503569	132	503639	182	503713	174	503796	176
500005	5	500149	7	502155	39	502267	29	503570	132	503640	183	503714	174	503797	176
500006	5	500151	7	502156	39	502268	29	503571	132	503641	183	503715	174	503798	176
500007	5	500152	7	502157	37	502269	28	503572	132	503642	183	503716	174	503799	176
500008	5	500153	7	502158	37	502271	28	503573	132	503643	183	503717	174	503800	176
500009	5	500155	7	502159	37	502273	29	503574	132	503644	183	503718	174	503801	176
500010	5	500162	7	502160	37	502274	28	503575	132	503645	183	503719	174	503802	176
500011	5	500163	7	502163	38	502282	29	503576	132	503646	183	503720	174	503803	176
500012	5	500165	7	502164	36	502283	28	503577	132	503647	139	503721	174	503804	176
500014	4	500168	4	502165	38	502291	29	503578	132	503648	139	503722	174	503805	176
500015	4	500169	4	502166	36	502292	29	503579	132	503649	139	503723	174	503806	176
500016	4	500170	4	502167	38	502293	29	503580	132	503650	151	503724	174	503807	176
500018	4	500171	4	502168	42	502294	29	503581	132	503651	151	503725	174	503808	176
500019	4	500172	4	502169	40	502295	29	503582	132	503652	174	503726	174	503809	176
500021	5	500173	4	502170	42	502296	29	503583	132	503653	174	503727	174	503810	176
500022	5	500174	5	502171	38	502319	52	503584	132	503654	174	503728	175	503811	176
500023	5	500175	5	502172	39	502320	52	503585	132	503655	174	503731	175	503812	176
500024	5	500176	6	502173	38	502321	52	503586	132	503656	174	503733	175	503813	176
500025	5	500177	6	502173	42	502322	52	503587	132	503657	174	503735	175	503814	176
500026	5	500178	6	502174	39	502323	54	503588	132	503661	174	503736	175	503815	176
500027	5	500179	6	502176	41	502325	52	503589	132	503663	175	503743	179	503816	176
500028	5	500180	6	502177	42	502327	53	503590	132	503664	175	503744	179	503817	177
500032	4	500199	4	502178	40	502336	52	503591	132	503665	175	503745	179	503821	176
500033	4	500200	4	502179	40	502337	54	503592	132	503666	175	503746	179	503822	176
500034	4	500201	4	502180	42	502338	52	503593	132	503667	175	503747	179	503823	176
500035	4	500212	7	502181	38	502339	52	503594	132	503668	175	503748	179	503824	176
500036	4	500214	8	502181	42	502366	54	503595	132	503669	175	503751	178	503825	176
500037	4	500215	8	502182	38	502367	53	503596	132	503670	174	503752	178	503826	176
500038	4	500217	8	502184	41	502368	54	503597	132	503671	174	503753	178	503827	176
500039	4	500218	8	502185	39	502369	54	503598	132	503672	174	503754	178	503828	176
500040	4	500220	8	502186	40	502371	54	503599	132	503673	174	503755	178	503829	176
500041	4	500222	8	502187	40	502375	52	503600	132	503674	174	503756	178	503830	176
500042	6	500225	8	502188	36	502376	52	503601	132	503675	174	503757	178	503831	176
500043	6	500227	8	502189	38	502377	53	503602	132	503676	174	503758	178	503832	176
500044	6	500831	2	502190	36	502378	53	503603	131	503677	174	503759	177	503833	176
500045	6	500833	2	502192	38	502380	52	503604	131	503678	174	503760	178	503834	176
500046	6	500835	2	502193	36	502381	53	503605	131	503679	174	503761	178	503835	176
500047	6	500836	2	502194	36	502382	53	503606	131	503680	174	503762	178	503836	176
500048	6	500838	2	502195	42	502383	52	503607	131	503681	174	503763	178	503837	176
500049	6	500839	2	502196	38	502385	53	503609	131	503682	174	503764	178	503838	176
500050	6	500840	2	502197	41	502387	52	503610	131	503683	174	503765	178	503839	176
500051	6	500844	3	502198	41	502388	53	503611	131	503684	174	503766	178	503840	176
500052	6	500848	3	502199	39	502389	53	503612	131	503685	174	503767	178	503841	176
500053	6	500855	3	502200	40	502390	53	503613	131	503686	174	503768	180	503842	176
500060	5	500859	3	502201	37	502391	53	503614	131	503687	174	503769	180	503843	176
500061	5	500870	3	502202	37	502392	53	503615	131	503688	174	503770	178	503844	176
500062	5	500876	3	502204	37	502395	52	503616	131	503689	174	503771	177	503845	176
500063	5	500884	3	502205	37	502396	52	503617	131	503690	174	503775	180	503846	176
500064	5	501221	294	502206	37	502397	52	503618	131	503691	174	503776	180	503847	176
500073	6	501222	294	502207	37	502398	52	503619	131	503692	174	503777	176	503848	176
500074	6	501223	294	502208	37	502400	54	503620	131	503693	174	503778	176	503849	176
500075	6	502109	238	502209	37	503090	187	503621	131	503694	174	503779	176	503850	176
500076	6	502110	238	502210	42	503472	216	503622	131	503695	174	503780	176	503851	176
500077	6	502111	238	502211	36	503473	216	503623	131	503696	174	503781	176	503852	176
500104	8	502112	238	502212	36	503474	216	503624	131	503697	174	503782	176	503853	176
500105	8	502113	238	502213	37	503476	216	503625	167	503699	175	503783	178	503854	176
500107	8	502116	238	502214	37	503477	216	503626	177	503700	174	503784	176	503855	176
500109	8	502118	238	502219	36	503478	216	503627	177	503701	174	503785	176	503856	176
500110	8	502126	238	502220	37	503479	216	503628	177	503702	174	503785	176	503857	176
500111	8	502141	238	502221	37	503480	216	503629	177	503703	174	503786	176	503858	176
500121	7	502145	37	502222	37	503481	216	503630	177	503704	174	503787	176	503859	176
500122	7	502146	37	502223	37	503482	216	503631	182	503705	174	503788	176	503860	176
500123	7	502147	37	502224	37	503497	216	503632	182	503706	174	503789	176	503861	176
500130	7	502148	39	502225	36	503502	216	503633	182	503707	174	503790	176	503862	176
500131	7	502149	42	502258	28	503504	216	503634	182	503708	174	503791	176	503863	176
500132	7	502150	42	502260	29	503505	216	503635	182	503709	174	503792	176	503871	178

# INDEX - Item Code

503873	167	503961	182	504030	181	504119	186	504188	185	504269	134	504341	133	504458	144
503874	177	503962	182	504031	181	504120	186	504189	185	504270	134	504342	133	504460	144
503875	177	503963	182	504032	181	504121	186	504190	185	504271	134	504343	133	504461	144
503876	177	503964	182	504033	181	504122	186	504191	185	504272	134	504344	133	504462	144
503877	177	503965	182	504034	183	504123	186	504192	185	504273	134	504345	133	504463	144
503878	177	503966	182	504035	184	504124	186	504193	185	504274	134	504346	133	504467	145
503879	177	503967	184	504036	130	504125	186	504194	185	504275	134	504347	133	504468	145
503880	177	503968	184	504037	130	504126	186	504195	185	504276	134	504348	133	504469	145
503881	177	503969	184	504038	130	504127	186	504196	185	504277	134	504349	133	504470	145
503900	184	503970	184	504039	130	504128	186	504197	185	504278	134	504350	133	504471	145
503901	184	503971	184	504040	130	504129	186	504198	185	504279	134	504351	133	504472	145
503902	184	503972	184	504041	130	504130	186	504199	185	504280	134	504352	133	504473	145
503903	182	503973	184	504042	130	504131	186	504200	185	504281	134	504353	133	504474	145
503904	182	503974	184	504043	183	504132	186	504201	185	504282	134	504354	133	504475	145
503905	182	503975	184	504044	183	504133	186	504202	185	504283	134	504355	133	504476	145
503906	182	503976	181	504045	183	504134	186	504203	185	504284	134	504356	133	504477	145
503907	182	503977	181	504046	183	504135	186	504204	185	504285	134	504357	133	504478	145
503908	182	503978	181	504048	183	504136	186	504205	185	504286	134	504358	133	504479	145
503909	183	503979	181	504049	131	504137	186	504206	185	504287	134	504359	133	504480	145
503910	182	503980	181	504050	131	504138	186	504207	185	504288	134	504360	133	504481	145
503911	182	503981	181	504051	131	504139	186	504208	185	504289	134	504361	133	504482	145
503912	185	503982	181	504052	131	504140	186	504209	185	504290	134	504362	133	504483	145
503913	185	503983	181	504053	131	504141	186	504210	185	504291	134	504363	133	504484	145
503914	182	503984	181	504054	131	504142	186	504211	185	504292	134	504364	133	504485	145
503915	183	503985	181	504055	131	504143	186	504212	185	504293	134	504368	134	504486	145
503916	181	503986	181	504056	131	504144	186	504213	185	504294	134	504369	134	504487	145
503917	181	503987	181	504057	131	504145	186	504214	185	504295	134	504370	134	504488	145
503918	181	503988	181	504058	131	504146	186	504215	185	504296	134	504384	135	504489	145
503919	181	503989	181	504059	131	504147	186	504216	185	504297	134	504385	135	504490	145
503920	181	503990	181	504060	131	504148	186	504217	185	504298	134	504387	135	504491	145
503921	181	503991	181	504061	131	504149	186	504218	185	504299	134	504388	135	504492	145
503922	181	503992	181	504069	130	504150	186	504219	185	504300	134	504389	135	504493	145
503923	181	503993	181	504070	130	504151	185	504220	185	504301	134	504390	135	504494	145
503924	181	503994	181	504071	130	504152	185	504221	185	504302	134	504393	138	504495	145
503925	181	503995	181	504072	130	504153	185	504222	185	504303	134	504399	146	504496	144
503926	181	503996	181	504073	130	504154	185	504223	185	504304	134	504401	137	504497	144
503927	181	503997	181	504074	130	504155	185	504224	185	504305	134	504404	136	504498	144
503928	181	503998	181	504075	130	504156	185	504225	186	504306	134	504405	136	504499	144
503929	181	503999	181	504076	130	504157	185	504226	186	504307	134	504406	136	504500	144
503930	181	504000	181	504077	130	504158	185	504227	186	504308	134	504407	136	504501	144
503931	181	504001	181	504078	130	504159	185	504228	186	504309	134	504408	136	504502	144
503932	181	504002	181	504079	130	504160	185	504229	186	504310	134	504409	136	504503	144
503933	181	504003	181	504080	130	504161	185	504231	186	504311	134	504410	136	504504	145
503934	181	504004	181	504081	130	504162	185	504232	187	504315	133	504411	137	504505	145
503935	181	504005	181	504082	130	504163	185	504233	135	504316	133	504412	137	504506	145
503936	181	504006	181	504083	130	504164	185	504234	135	504317	133	504414	137	504507	145
503937	181	504007	181	504089	187	504165	185	504235	135	504318	133	504415	137	504508	145
503938	181	504008	181	504091	187	504166	185	504240	135	504319	133	504416	137	504509	145
503939	181	504009	181	504098	186	504167	185	504241	135	504320	133	504417	137	504510	145
503940	181	504010	181	504099	186	504168	185	504242	135	504321	133	504418	137	504511	145
503941	181	504011	181	504100	186	504169	185	504243	135	504322	133	504420	137	504512	145
503942	181	504012	181	504101	186	504170	185	504244	135	504323	133	504421	137	504513	144
503943	181	504013	181	504102	186	504171	185	504245	135	504324	133	504422	137	504514	144
503944	181	504014	181	504103	186	504172	185	504246	135	504325	133	504423	137	504515	144
503945	181	504015	181	504104	186	504173	185	504247	138	504326	133	504424	137	504516	144
503946	181	504016	181	504105	186	504174	185	504248	139	504327	133	504425	137	504517	144
503947	181	504017	181	504106	186	504175	185	504249	139	504328	133	504426	137	504518	144
503948	181	504018	181	504107	186	504176	185	504250	138	504329	133	504427	138	504519	144
503949	181	504019	181	504108	186	504177	185	504253	139	504330	133	504428	138	504520	144
503950	181	504020	181	504109	186	504178	185	504255	139	504331	133	504429	138	504521	144
503951	181	504021	181	504110	186	504179	185	504257	140	504332	133	504430	138	504522	144
503952	181	504022	181	504111	186	504180	185	504260	135	504333	133	504433	138	504523	151
503953	181	504023	181	504112	186	504181	185	504261	140	504334	133	504436	136	504524	151
503954	181	504024	181	504113	186	504182	185	504262	135	504335	133	504438	147	504525	151
503955	181	504025	181	504114	186	504183	185	504264	140	504336	133	504439	136	504526	151
503956	181	504026	181	504115	186	504184	185	504265	140	504337	133	504440	138	504527	151
503957	181	504027	181	504116	186	504185	185	504266	134	504338	133	504441	138	504528	151
503958	181	504028	181	504117	186	504186	185	504267	134	504339	133	504456	144	504529	151
503959	181	504029	181	504118	186	504187	185	504268	134	504340	133	504457	144	504530	151



# INDEX - Item Code

504531	151	504612	143	504686	141	504774	148	504853	158	504978	156	505050	157	505127	155
504532	151	504613	143	504687	141	504775	148	504854	158	504981	156	505051	157	505128	155
504533	151	504614	143	504688	141	504776	148	504855	158	504982	156	505052	157	505129	155
504534	132	504615	143	504689	141	504777	148	504856	158	504983	156	505053	157	505130	155
504537	152	504616	143	504690	141	504778	148	504857	158	504984	156	505054	157	505131	155
504539	153	504617	143	504691	141	504779	148	504858	158	504985	156	505055	157	505132	155
504540	152	504618	143	504692	141	504780	149	504859	158	504986	156	505056	157	505133	155
504541	153	504619	143	504693	141	504781	149	504861	163	504987	156	505057	157	505134	155
504542	143	504620	143	504694	141	504782	149	504862	163	504988	156	505058	157	505135	155
504545	153	504621	143	504695	141	504783	149	504863	163	504989	156	505063	157	505136	155
504546	153	504622	143	504696	141	504784	149	504864	163	504990	156	505064	157	505137	155
504547	153	504623	143	504697	141	504785	149	504865	163	504991	156	505065	157	505138	155
504548	153	504624	143	504698	141	504786	149	504866	163	504992	156	505066	157	505139	155
504551	153	504625	143	504699	141	504787	149	504867	163	504993	156	505067	157	505140	155
504552	152	504626	143	504700	141	504788	149	504879	163	504994	156	505068	157	505141	155
504556	154	504627	143	504701	141	504789	149	504880	163	504995	156	505071	155	505142	155
504557	154	504628	143	504702	141	504791	150	504881	163	504996	156	505072	155	505143	155
504558	154	504629	143	504703	141	504792	149	504882	163	504997	156	505073	155	505144	155
504560	142	504630	143	504704	141	504794	150	504883	163	504999	156	505074	155	505145	155
504561	142	504631	152	504705	142	504796	150	504884	163	505000	156	505075	155	505146	155
504562	142	504636	150	504706	142	504797	147	504885	163	505001	156	505076	155	505147	155
504563	142	504638	150	504707	142	504798	147	504886	163	505002	156	505077	155	505148	155
504564	142	504639	141	504708	142	504799	148	504887	163	505003	156	505078	155	505149	155
504565	142	504640	141	504709	142	504800	147	504888	163	505004	156	505079	155	505150	155
504566	142	504641	141	504710	142	504801	147	504905	164	505005	156	505080	155	505151	155
504567	142	504642	141	504711	142	504802	147	504906	164	505006	156	505081	155	505152	155
504568	142	504643	141	504712	142	504804	148	504907	164	505007	164	505082	155	505153	155
504569	142	504644	141	504713	142	504806	146	504909	164	505008	164	505083	155	505154	155
504570	142	504645	141	504714	142	504807	146	504910	164	505009	164	505084	155	505155	155
504572	152	504646	141	504715	142	504808	146	504911	164	505010	164	505086	155	505156	155
504573	152	504647	141	504716	142	504809	150	504912	164	505011	164	505087	155	505157	155
504574	152	504648	141	504717	142	504811	150	504913	164	505012	164	505088	155	505158	155
504575	152	504649	141	504718	142	504814	159	504914	164	505013	157	505089	155	505159	155
504576	143	504650	141	504719	142	504815	159	504915	164	505014	157	505090	155	505160	155
504577	142	504651	141	504720	142	504816	159	504916	164	505015	157	505091	155	505161	155
504578	142	504652	141	504721	142	504817	159	504917	164	505016	157	505092	155	505162	155
504579	142	504653	141	504732	144	504818	159	504918	132	505017	157	505093	155	505163	155
504580	143	504654	141	504733	144	504819	159	504919	167	505018	157	505094	155	505164	155
504581	142	504655	141	504734	144	504820	159	504922	163	505019	157	505095	155	505165	155
504582	142	504656	141	504735	144	504821	159	504923	163	505020	157	505096	155	505166	155
504583	143	504657	141	504736	144	504822	159	504924	163	505021	157	505097	155	505167	155
504584	142	504658	141	504737	144	504823	159	504933	165	505022	157	505098	155	505168	155
504585	142	504659	141	504738	144	504824	159	504934	165	505023	157	505099	155	505169	155
504586	143	504660	141	504739	144	504825	159	504939	165	505024	157	505100	155	505170	155
504587	142	504661	141	504740	144	504826	159	504945	165	505025	157	505101	155	505171	155
504588	142	504662	141	504741	144	504827	159	504947	165	505026	157	505102	155	505172	155
504589	143	504663	141	504742	144	504828	159	504948	165	505027	157	505103	155	505173	155
504590	142	504664	141	504743	144	504829	159	504953	165	505028	157	505104	155	505174	155
504591	142	504665	141	504744	144	504830	159	504956	166	505029	157	505105	155	505175	155
504592	142	504666	141	504745	151	504831	159	504958	166	505030	157	505106	155	505176	155
504593	142	504667	141	504746	151	504832	159	504959	167	505031	157	505107	155	505177	155
504594	142	504668	141	504747	151	504833	159	504960	156	505032	157	505108	155	505178	155
504595	142	504669	141	504748	146	504834	159	504961	156	505033	157	505109	155	505179	156
504596	142	504670	141	504751	146	504835	159	504962	156	505034	157	505110	155	505180	156
504597	142	504671	141	504752	159	504836	159	504963	156	505035	157	505111	155	505181	156
504598	142	504672	141	504755	146	504837	159	504964	156	505036	157	505112	155	505182	156
504599	152	504673	141	504756	148	504838	159	504965	156	505037	157	505113	155	505183	156
504600	152	504674	141	504758	147	504839	159	504966	156	505038	157	505114	155	505184	156
504601	152	504675	141	504760	147	504842	164	504967	156	505039	157	505115	155	505185	156
504602	143	504676	141	504761	147	504843	158	504968	156	505040	157	505116	155	505186	156
504603	143	504677	141	504762	148	504844	158	504969	156	505041	157	505117	155	505187	156
504604	143	504678	141	504764	146	504845	158	504970	156	505042	157	505118	155	505188	156
504605	143	504679	141	504765	148	504846	158	504971	156	505043	157	505119	155	505189	156
504606	143	504680	141	504767	148	504847	158	504972	156	505044	157	505120	155	505190	156
504607	143	504681	141	504768	148	504848	158	504973	156	505045	157	505121	155	505191	156
504608	143	504682	141	504770	148	504849	158	504974	156	505046	157	505122	155	505192	156
504609	143	504683	141	504771	148	504850	158	504975	156	505047	157	505123	155	505193	156
504610	143	504684	141	504772	148	504851	158	504976	156	505048	157	505125	155	505194	156
504611	143	504685	141	504773	148	504852	158	504977	156	505049	157	505126	155	505195	156

# INDEX - Item Code

505196	156	505293	169	505363	168	505438	169	505515	173	505612	156	506219	18	506482	230
505198	156	505294	169	505364	168	505439	169	505516	172	505613	156	506220	18	506486	221
505199	163	505295	169	505365	168	505440	169	505518	131	505615	133	506227	19	506487	221
505202	157	505296	169	505366	168	505441	169	505519	131	505620	167	506228	19	506491	227
505203	157	505297	169	505367	168	505443	170	505520	131	505978	203	506229	19	506493	227
505204	157	505298	169	505368	168	505445	170	505528	179	505979	203	506230	19	506495	221
505205	157	505299	169	505369	168	505446	170	505533	150	505980	203	506231	19	506500	221
505206	157	505300	169	505370	168	505447	173	505534	137	505981	203	506232	19	506501	221
505207	157	505301	169	505371	168	505448	173	505535	137	505982	203	506233	19	506503	220
505210	163	505302	169	505372	168	505449	173	505536	149	505983	203	506234	19	506504	220
505212	164	505303	169	505373	168	505451	173	505537	149	505984	203	506235	19	506505	229
505213	162	505304	169	505374	168	505452	172	505538	162	505985	203	506236	19	506508	218
505214	159	505305	169	505375	168	505453	172	505539	162	505986	203	506237	19	506511	218
505215	159	505306	169	505376	168	505454	172	505541	177	505987	203	506238	19	506512	222
505217	161	505307	169	505377	168	505455	172	505542	176	505989	203	506239	19	506513	222
505220	159	505308	169	505378	168	505456	172	505543	135	505990	203	506240	19	506514	222
505221	160	505309	169	505379	168	505457	172	505544	135	505993	203	506241	19	506515	218
505223	160	505310	169	505380	168	505458	172	505545	135	505995	203	506242	19	506516	222
505226	160	505311	169	505381	168	505459	172	505546	135	505996	203	506243	19	506517	218
505227	160	505312	169	505382	168	505460	172	505547	135	506000	203	506244	19	506519	224
505228	160	505313	169	505383	168	505461	172	505548	134	506001	203	506245	19	506522	224
505229	160	505314	169	505384	168	505462	172	505549	134	506003	203	506246	19	506525	222
505230	161	505315	169	505385	168	505463	172	505551	134	506005	202	506247	19	506526	223
505232	161	505316	169	505386	168	505464	172	505552	134	506006	202	506248	19	506527	223
505234	162	505317	169	505387	168	505465	172	505553	133	506009	202	506249	19	506538	227
505235	162	505318	169	505388	168	505466	172	505554	133	506012	202	506250	19	506542	222
505236	162	505319	169	505389	168	505467	172	505555	133	506013	202	506251	19	506543	222
505236	162	505320	169	505390	168	505468	172	505556	133	506018	202	506252	19	506544	222
505237	162	505321	169	505391	168	505469	172	505557	133	506019	202	506253	19	506546	228
505238	162	505322	169	505392	168	505470	172	505559	135	506020	202	506254	19	506547	229
505239	162	505323	169	505393	168	505471	172	505560	144	506021	202	506255	19	506548	229
505240	162	505324	169	505394	168	505472	172	505561	144	506022	202	506256	19	506550	230
505241	162	505325	169	505395	168	505473	172	505562	144	506023	202	506407	230	506553	223
505242	162	505326	169	505396	168	505474	172	505563	146	506024	202	506408	230	506555	223
505243	162	505327	169	505397	168	505475	172	505564	146	506025	202	506411	219	506558	223
505244	162	505328	169	505398	168	505476	172	505565	145	506027	202	506417	229	506561	223
505245	162	505329	169	505399	168	505477	172	505566	145	506181	18	506418	229	506566	223
505246	161	505330	169	505400	168	505478	172	505567	145	506182	18	506419	221	506567	222
505247	161	505331	169	505401	168	505479	172	505568	145	506183	18	506421	219	506568	222
505248	161	505332	169	505402	168	505480	172	505569	151	506184	18	506422	219	506575	228
505250	161	505333	169	505403	168	505481	172	505570	151	506185	18	506424	219	506579	228
505251	161	505334	169	505404	168	505482	172	505571	142	506186	18	506425	229	506581	228
505252	161	505335	169	505405	168	505483	172	505573	142	506187	18	506426	219	506583	228
505253	161	505336	169	505406	168	505484	172	505574	143	506188	18	506427	219	506585	228
505254	161	505337	169	505407	168	505485	172	505577	142	506189	18	506428	219	506587	228
505255	161	505338	169	505408	168	505486	172	505578	142	506190	18	506429	219	506588	228
505257	161	505339	169	505409	168	505487	172	505579	143	506191	18	506430	218	506589	229
505258	160	505340	169	505410	168	505488	172	505580	144	506193	18	506431	218	506590	228
505259	160	505341	169	505411	168	505489	172	505581	141	506194	18	506432	219	506593	228
505260	160	505342	169	505412	168	505490	172	505582	141	506196	18	506433	219	506594	228
505262	162	505343	169	505413	168	505491	172	505585	141	506197	18	506436	221	506596	224
505263	162	505344	169	505414	168	505492	172	505586	141	506198	18	506438	220	506602	223
505265	162	505345	169	505415	168	505493	172	505588	142	506199	18	506442	226	506603	223
505266	168	505346	169	505416	168	505494	172	505590	144	506200	18	506444	226	506606	227
505267	168	505347	169	505417	168	505495	172	505591	144	506201	18	506445	221	506608	222
505268	168	505348	169	505418	168	505496	172	505593	142	506202	18	506446	227	506610	222
505269	168	505349	169	505419	168	505497	172	505594	158	506203	18	506448	226	506616	223
505270	168	505350	169	505420	168	505498	172	505595	159	506204	18	506451	226	506618	223
505271	168	505352	168	505421	168	505499	172	505596	159	506205	18	506456	226	506621	230
505275	170	505353	168	505422	168	505500	172	505597	158	506206	18	506458	223	506622	230
505276	170	505354	168	505423	168	505501	172	505598	158	506207	18	506465	229	506623	230
505278	170	505355	168	505424	168	505502	172	505599	158	506208	18	506469	219	506626	224
505279	170	505356	168	505425	170	505503	172	505600	158	506209	18	506470	220	506627	224
505284	171	505357	168	505426	170	505504	172	505603	157	506210	18	506471	220	506628	224
505285	171	505358	168	505428	169	505505	172	505604	157	506211	18	506472	220	506629	227
505286	171	505359	168	505429	169	505509	172	505605	157	506212	18	506473	220	506630	224
505287	171	505360	168	505434	169	505510	172	505606	157	506213	18	506476	227	506868	177
505291	169	505361	168	505436	169	505511	173	505608	156	506214	18	506477	230	506869	177
505292	169	505362	168	505437	169	505513	172	505610	156	506215	18	506480	218	506871	280

# INDEX - Item Code

506872	280	507101	254	507564	270	507908	50	508394	199	508917	44	508994	45	509209	290
506873	280	507102	262	507565	273	507909	50	508395	199	508918	48	508995	47	509376	291
506884	12	507103	262	507566	273	507911	50	508396	199	508921	45	508996	48	509404	290
506885	11	507104	261	507567	273	507912	50	508400	200	508923	44	508997	46	509405	290
506894	12	507105	261	507568	273	507914	50	508402	200	508924	44	508998	47	509406	291
506895	12	507106	261	507569	272	508208	193	508408	200	508925	44	508999	46	509407	291
506902	11	507107	255	507584	272	508211	190	508421	198	508926	44	509000	47	509408	291
506903	11	507108	253	507617	272	508223	192	508422	198	508927	44	509001	46	509423	290
506907	11	507109	253	507710	276	508224	192	508423	198	508928	44	509002	47	509426	290
506912	12	507110	257	507711	276	508226	194	508424	198	508929	44	509003	46	509427	290
506913	12	507111	262	507712	276	508227	194	508805	33	508930	48	509004	47	509428	290
506917	11	507112	262	507713	277	508228	194	508806	33	508934	44	509005	46	509429	290
506923	11	507113	252	507714	277	508229	190	508807	33	508935	47	509006	47	509449	291
506944	12	507114	253	507715	277	508230	190	508808	33	508936	44	509007	46	509450	291
506948	12	507115	253	507716	277	508231	190	508809	33	508937	47	509008	47	509451	291
506949	12	507120	260	507717	274	508232	190	508810	33	508938	44	509009	46	509513	288
506954	10	507123	266	507718	274	508233	190	508811	33	508939	47	509010	47	509518	291
507043	26	507124	258	507719	274	508234	190	508812	33	508940	47	509011	46	509520	289
507044	26	507125	254	507720	279	508235	190	508813	33	508941	44	509012	47	509521	289
507045	26	507126	254	507721	277	508236	190	508814	33	508942	47	509014	48	509522	290
507050	259	507127	254	507722	277	508237	190	508815	33	508943	44	509015	48	509530	289
507051	258	507128	254	507723	276	508238	190	508816	33	508944	47	509016	48	509531	289
507052	255	507129	257	507724	276	508240	194	508817	33	508945	44	509017	48	509536	291
507053	255	507167	261	507725	277	508241	194	508818	34	508946	45	509018	48	509541	288
507054	255	507168	261	507726	276	508242	194	508819	34	508947	45	509019	48	509542	288
507055	255	507170	264	507727	276	508243	194	508820	34	508948	45	509020	48	509543	288
507056	255	507171	264	507728	276	508244	194	508821	34	508949	44	509022	48	509544	289
507057	257	507172	265	507729	274	508245	191	508823	33	508950	47	509033	56	509545	289
507058	257	507173	265	507730	274	508245	193	508833	33	508951	46	509034	56	509547	288
507059	257	507174	265	507731	278	508246	191	508834	33	508953	45	509035	56	509548	288
507060	259	507175	265	507732	278	508246	193	508835	33	508954	47	509036	56	509568	310
507061	258	507177	263	507733	278	508247	191	508836	33	508955	45	509037	56	509569	310
507062	256	507178	263	507734	278	508247	193	508837	33	508956	47	509038	56	509570	309
507063	256	507180	263	507735	278	508248	191	508838	33	508957	45	509039	56	509571	310
507064	255	507181	263	507736	278	508248	193	508839	33	508958	47	509040	56	509572	310
507065	256	507183	263	507737	278	508252	193	508840	33	508959	45	509041	56	509573	309
507066	256	507207	267	507738	277	508253	191	508842	34	508960	47	509044	56	509574	309
507067	255	507208	267	507739	276	508256	191	508843	34	508961	45	509045	56	509575	309
507068	264	507209	267	507740	277	508257	191	508844	34	508962	47	509046	56	509576	309
507069	264	507211	263	507741	279	508258	191	508845	33	508963	45	509047	56	509577	310
507070	264	507213	263	507742	280	508260	191	508846	34	508964	47	509048	56	509578	309
507071	266	507214	267	507745	280	508262	191	508847	34	508965	48	509056	57	509579	309
507073	252	507216	267	507747	280	508264	191	508848	34	508966	48	509057	57	509580	309
507074	252	507218	267	507748	280	508265	191	508849	34	508968	46	509058	57	509581	310
507075	252	507219	267	507749	275	508266	191	508850	34	508969	46	509059	57	509582	309
507076	252	507223	267	507750	274	508267	191	508861	32	508970	46	509060	57	509583	309
507078	262	507224	267	507752	274	508268	191	508864	32	508971	45	509061	57	509585	310
507079	266	507400	269	507754	275	508270	191	508867	32	508972	47	509062	57	509587	309
507080	266	507403	268	507756	274	508271	191	508868	32	508973	48	509063	57	509597	310
507081	266	507425	268	507757	276	508272	191	508869	32	508974	45	509064	57	509622	310
507082	266	507426	268	507771	275	508274	191	508870	32	508975	47	509065	57	509624	309
507083	265	507429	269	507772	275	508275	191	508896	44	508976	48	509066	57	509625	309
507084	265	507458	269	507792	274	508276	191	508897	48	508977	48	509067	57	509626	309
507085	265	507460	269	507793	275	508280	191	508898	44	508978	46	509068	57	509627	310
507086	265	507461	269	507809	276	508281	191	508900	46	508979	45	509070	57	509648	309
507087	259	507473	268	507829	279	508316	199	508901	48	508980	47	509071	57	509658	308
507088	257	507474	268	507842	279	508318	199	508902	46	508981	48	509072	57	509659	309
507089	257	507475	268	507844	279	508353	199	508903	46	508982	48	509073	57	509675	308
507090	258	507476	268	507845	279	508363	200	508904	46	508983	46	509074	57	509678	308
507091	259	507477	268	507846	279	508364	200	508905	46	508984	45	509075	57	509680	309
507092	259	507478	270	507847	279	508366	200	508906	44	508985	47	509076	57	509683	308
507093	258	507487	271	507849	279	508376	198	508907	46	508986	48	509077	57	509684	308
507094	255	507494	270	507851	279	508379	198	508908	45	508987	46	509078	57	509686	308
507095	256	507497	270	507897	50	508380	198	508910	48	508988	45	509079	57	509688	309
507096	256	507502	271	507898	50	508381	198	508911	44	508989	47	509080	57	510232	290
507097	256	507545	271	507899	50	508383	198	508912	45	508990	48	509081	57	510666	253
507098	257	507550	272	507900	50	508388	198	508913	48	508991	46	509082	57	510804	226
507099	253	507562	272	507904	50	508390	199	508915	44	508992	46	509083	57	510805	226
507100	252	507563	270	507906	50	508393	199	508916	45	508993	45	509132	290	510808	230

# INDEX - Item Code

510878	50	700612	304	703087	211	703251	22	703600	319	704333	316	704504	324	704934	15
510879	50	700629	303	703088	211	703252	22	703600	320	704334	316	704514	326	704935	15
510880	50	700680	296	703095	208	703255	22	703601	313	704335	316	704520	325	704936	15
510881	50	700723	296	703100	208	703256	22	703602	313	704336	316	704525	325	704937	15
510882	50	700730	296	703101	208	703264	22	703603	313	704337	316	704528	325	704938	15
510883	50	700741	298	703102	211	703273	22	703604	313	704338	316	704529	324	704939	15
510884	50	700742	298	703108	206	703274	22	703605	313	704339	316	704530	324	704940	15
510885	50	700744	299	703109	206	703276	22	703606	313	704340	316	704531	324	704941	15
510886	50	700745	299	703110	210	703277	22	703926	312	704341	316	704533	324	704998	66
510887	50	700746	299	703111	207	703278	23	703927	312	704342	316	704535	324	705001	66
510888	50	700749	299	703112	206	703279	22	703928	312	704343	316	704537	324	705002	66
510909	228	700750	299	703116	207	703280	22	703929	312	704344	316	704539	324	705007	66
510911	255	700751	300	703120	206	703283	22	703930	312	704345	316	704542	324	705008	66
510912	255	700754	298	703124	206	703284	23	703931	312	704346	316	704544	324	705009	66
510913	255	700755	300	703125	208	703285	22	703932	312	704347	316	704547	325	705010	66
510919	10	700767	296	703126	208	703286	22	703933	312	704348	316	704548	325	705011	66
510920	10	700819	296	703127	208	703290	22	703936	312	704349	316	704563	324	705012	66
510921	10	700821	297	703129	210	703298	23	703937	312	704350	316	704568	324	705013	66
511015	259	700835	299	703130	206	703299	22	703938	312	704351	316	704569	324	705014	66
511016	260	700959	297	703133	212	703301	22	703939	312	704352	316	704570	324	705015	66
511017	260	700960	305	703137	214	703302	23	703940	312	704353	316	704578	324	705016	66
511018	260	700962	297	703138	211	703303	22	703941	312	704354	316	704851	14	705017	66
511019	261	700963	297	703139	214	703306	23	703942	312	704355	322	704853	14	705018	66
511028	220	700964	297	703140	214	703307	22	703944	312	704356	322	704855	14	705019	66
511029	223	700965	297	703141	214	703309	22	703945	312	704359	316	704856	14	705020	66
511030	224	700967	297	703142	214	703313	22	703947	321	704372	320	704857	14	705021	66
511045	224	700968	297	703143	214	703315	22	703948	318	704374	318	704858	14	705022	66
511046	220	700969	297	703144	212	703329	23	703949	319	704374	319	704859	14	705023	66
511083	148	700970	297	703148	209	703330	22	703952	318	704374	322	704861	14	705024	66
511089	38	700985	296	703149	211	703333	22	703952	319	704378	320	704862	14	705025	66
511093	41	701031	305	703150	211	703336	22	703952	322	704379	318	704869	14	705027	66
511116	229	701034	297	703151	210	703339	22	704292	315	704379	319	704870	14	705028	66
511117	229	701056	304	703152	213	703344	22	704293	315	704379	322	704871	14	705029	66
511118	229	701064	304	703153	212	703346	22	704294	315	704409	326	704872	14	705030	66
511119	274	701111	303	703154	214	703348	22	704295	315	704410	326	704873	14	705031	66
511123	41	701130	303	703156	208	703350	23	704296	315	704412	326	704875	14	705032	66
511124	41	701150	298	703159	209	703351	22	704297	315	704416	326	704876	14	705033	66
511171	32	701153	298	703160	211	703353	24	704298	315	704417	326	704877	14	705034	66
511188	162	701156	298	703161	210	703362	23	704299	315	704419	326	704884	14	705035	66
511194	165	701379	297	703162	212	703363	23	704300	315	704424	326	704885	14	705036	66
511195	165	701439	297	703165	210	703365	23	704301	315	704425	326	704886	14	705037	66
700238	303	702743	284	703169	206	703373	23	704302	315	704426	326	704887	14	705038	66
700274	305	702746	282	703171	209	703375	23	704303	315	704427	326	704888	14	705039	66
700282	300	702747	282	703172	210	703376	23	704304	315	704428	326	704889	14	705040	66
700301	300	702748	282	703173	210	703379	23	704305	315	704441	326	704890	14	705041	66
700314	302	702750	285	703175	210	703380	23	704306	315	704442	326	704891	14	705042	66
700315	301	702750	285	703176	208	703383	24	704307	315	704443	326	704892	14	705043	66
700316	301	702751	285	703177	209	703384	313	704308	315	704444	326	704893	14	705044	66
700317	301	702751	285	703178	209	703575	313	704309	315	704445	326	704903	15	705045	66
700318	301	702752	282	703179	211	703576	313	704310	315	704446	326	704904	15	705046	66
700319	301	702753	282	703180	212	703577	313	704311	315	704447	326	704905	15	705047	66
700320	301	702754	282	703182	213	703578	313	704312	315	704448	325	704906	15	705048	66
700321	301	702755	282	703183	213	703579	313	704313	315	704451	326	704907	15	705049	66
700322	302	702755	284	703186	212	703580	313	704314	315	704454	325	704908	15	705050	66
700323	301	702756	284	703187	209	703581	313	704315	315	704461	325	704909	15	705051	66
700325	303	702758	284	703188	209	703582	313	704316	315	704463	325	704912	15	705052	66
700327	303	702759	283	703194	209	703583	313	704317	315	704464	325	704914	15	705053	66
700331	303	702760	283	703195	209	703584	313	704318	315	704469	325	704915	15	705054	66
700335	303	702761	282	703196	209	703585	313	704319	315	704470	325	704917	15	705055	66
700338	303	702762	282	703197	209	703586	313	704320	315	704471	325	704919	15	705056	66
700341	303	702804	283	703198	212	703588	318	704321	315	704479	325	704920	15	705057	66
700343	303	702805	283	703201	213	703588	319	704325	316	704481	324	704921	15	705058	66
700413	297	702847	284	703202	213	703588	320	704326	316	704482	324	704923	15	705059	66
700415	305	702848	284	703229	22	703590	320	704327	316	704483	324	704925	15	705060	66
700416	305	702849	285	703234	22	703590	322	704328	316	704485	324	704927	15	705061	66
700417	305	702850	285	703236	22	703592	320	704329	316	704486	326	704930	15	705062	66
700578	304	702854	282	703238	22	703593	320	704330	316	704487	325	704931	15	705063	66
700610	297	702855	282	703242	22	703595	320	704331	316	704488	325	704932	15	705065	66
700611	297	703085	206	703249	22	703600	318	704332	316	704492	325	704933	15	705067	66

# INDEX - Item Code

705070	66	705246	74	705428	116	705698	69	705966	67	706134	68	706374	70	706522	71
705072	124	705247	74	705429	116	705699	69	705967	67	706136	68	706377	70	706523	71
705073	124	705248	74	705430	116	705700	69	705968	67	706138	68	706378	70	706524	71
705074	124	705304	115	705431	116	705701	69	705969	67	706140	68	706379	70	706546	72
705075	124	705305	115	705433	116	705702	69	705970	67	706142	68	706381	70	706547	72
705076	124	705306	116	705434	116	705703	69	705971	67	706143	68	706391	84	706548	72
705082	124	705307	116	705471	125	705704	69	705972	67	706144	68	706392	84	706549	72
705083	124	705308	116	705472	125	705705	69	705973	67	706147	68	706393	84	706550	72
705084	124	705309	116	705498	125	705706	69	705974	67	706150	68	706394	84	706552	72
705085	124	705310	116	705499	125	705725	125	705975	67	706152	68	706395	84	706554	72
705086	124	705311	116	705500	125	705727	125	705976	67	706153	68	706397	89	706555	72
705087	124	705312	116	705501	125	705728	125	705977	67	706155	68	706398	89	706556	72
705097	125	705313	116	705502	125	705742	87	705978	67	706156	68	706399	89	706557	72
705098	125	705314	116	705503	125	705749	126	705980	67	706157	68	706400	89	706558	72
705114	127	705315	116	705504	125	705752	128	705981	67	706158	68	706401	91	706559	72
705132	125	705316	116	705505	125	705753	126	705983	67	706160	68	706402	91	706560	72
705133	125	705317	116	705524	124	705754	127	705985	67	706162	68	706403	90	706561	72
705134	125	705318	116	705525	124	705755	126	705986	67	706164	68	706404	90	706562	72
705136	127	705319	116	705526	124	705756	126	705986	126	706169	69	706405	90	706563	72
705141	127	705320	116	705527	124	705761	127	705987	67	706170	69	706406	70	706564	72
705142	90	705321	116	705528	124	705761	127	705987	67	706171	69	706407	70	706565	72
705143	90	705322	116	705532	124	705809	115	705988	67	706174	69	706408	70	706566	72
705144	91	705323	116	705533	124	705810	115	705989	67	706175	69	706409	71	706567	72
705145	91	705324	116	705534	124	705811	115	705990	67	706177	69	706410	71	706568	72
705146	91	705325	116	705560	124	705812	115	705991	67	706181	69	706412	71	706569	72
705147	91	705326	116	705561	124	705816	115	705992	67	706181	69	706413	71	706570	72
705148	91	705327	116	705562	124	705817	115	705994	67	706293	70	706414	71	706571	72
705149	91	705328	116	705562	124	705818	115	705996	67	706294	70	706417	71	706572	72
705150	91	705329	116	705563	124	705819	115	705998	67	706295	70	706418	71	706573	72
705151	90	705330	116	705564	124	705821	127	706000	67	706296	70	706419	71	706574	72
705152	89	705331	116	705565	124	705822	127	706002	67	706297	70	706420	71	706575	72
705153	89	705333	115	705566	124	705823	127	706003	67	706298	70	706421	71	706576	72
705154	89	705334	115	705567	124	705824	127	706005	67	706327	70	706422	71	706577	72
705155	89	705335	115	705568	124	705824	127	706006	67	706329	70	706423	71	706578	73
705156	89	705337	116	705569	124	705847	126	706008	67	706330	70	706424	71	706580	73
705157	89	705338	116	705570	124	705881	126	706009	67	706331	70	706425	71	706581	73
705158	89	705374	116	705571	124	705890	127	706010	67	706332	70	706427	71	706582	73
705159	89	705375	116	705572	124	705892	127	706011	67	706333	70	706428	71	706583	73
705160	89	705377	116	705573	124	705893	127	706013	67	706334	70	706429	72	706584	73
705165	115	705378	116	705574	66	705894	127	706015	67	706336	70	706430	72	706586	73
705166	115	705379	116	705576	66	705895	126	706017	67	706337	70	706431	72	706587	73
705167	115	705380	116	705578	66	705902	127	706019	67	706338	70	706432	72	706588	73
705168	115	705381	116	705579	66	705903	127	706021	67	706339	70	706433	72	706589	73
705175	115	705382	116	705580	124	705904	127	706023	67	706340	70	706434	72	706590	73
705176	115	705383	116	705581	124	705905	127	706024	67	706341	70	706435	72	706591	73
705178	115	705384	116	705582	124	705910	127	706026	67	706342	70	706436	72	706592	73
705181	125	705385	116	705583	124	705911	127	706027	68	706343	70	706437	72	706593	73
705209	125	705386	116	705584	124	705912	127	706028	68	706344	70	706438	72	706594	73
705211	125	705387	116	705585	124	705913	127	706030	68	706345	70	706439	72	706595	73
705212	125	705388	116	705586	124	705914	127	706032	68	706346	70	706440	72	706596	73
705213	125	705389	116	705587	124	705915	127	706033	68	706347	70	706441	72	706597	73
705218	125	705390	116	705588	124	705916	127	706034	68	706348	70	706442	72	706598	73
705229	74	705391	116	705589	124	705917	127	706035	68	706349	70	706443	72	706599	73
705230	74	705392	116	705590	124	705918	127	706037	68	706350	70	706444	72	706600	73
705231	74	705393	116	705591	124	705919	127	706038	67	706351	70	706445	72	706601	73
705232	74	705394	116	705592	124	705920	127	706039	68	706352	70	706446	72	706602	73
705233	74	705395	116	705593	124	705921	127	706040	68	706353	70	706447	72	706603	73
705234	74	705396	116	705594	124	705922	127	706041	68	706354	70	706448	72	706604	73
705235	74	705397	116	705595	124	705923	127	706042	68	706355	70	706449	72	706605	73
705236	74	705398	116	705596	124	705924	127	706043	68	706356	70	706450	72	706606	73
705237	74	705399	116	705597	124	705925	127	706044	68	706357	70	706451	72	706607	73
705238	74	705400	116	705598	124	705926	127	706045	68	706358	70	706452	72	706608	73
705239	74	705401	116	705599	124	705927	127	706046	68	706359	70	706453	72	706609	73
705240	74	705402	116	705600	124	705928	127	706047	68	706360	70	706454	72	706610	73
705241	74	705403	116	705601	124	705929	127	706048	126	706361	70	706455	72	706611	73
705242	74	705404	116	705602	124	705930	127	706049	126	706362	70	706456	72	706612	73
705243	74	705405	116	705603	124	705931	127	706050	126	706363	70	706457	72	706613	73
705244	74	705406	116	705604	124	705932	127	706051	126	706364	70	706458	72	706614	73
705245	74	705407	116	705605	124	705933	127	706052	126	706365	70	706459	72	706615	73
		705408	116	705606	124	705934	127	706053	126	706366	70	706460	72	706616	73
		705409	116	705607	124	705935	127	706054	126	706367	70	706461	72	706617	73
		705410	116	705608	124	705936	127	706055	126	706368	70	706462	72	706618	73
		705411	116	705609	124	705937	127	706056	126			706463	72	706619	73
		705412	116	705610	124	705938	127	706057	126			706464	72	706620	73
		705413	116	705611	124	705939	127	706058	126			706465	72	706621	73
		705414	116	705612	124	705940	127	706059	126			706466	72	706622	73
		705415	116	705613	124	705941	127	706060	126			706467	72	706623	73
		705416	116	705614	124	705942	127	706061	126			706468	72	706624	73
		705417	116	705615	124	705943	127	706062	126			706469	72	706625	73
		705418	116	705616	124	705944	127	706063	126			706470	72	706626	73
		705419	116	705617	124	705945	127	706064	126			706471	72	706627	73
		705420	116	705618	124	705946	127	706065	126			706472	72	706628	73
		705421	116	70561											

# INDEX - Item Code

706655	73	706848	74	707024	75	707196	79	707352	85	707519	114	707757	112	707853	88
706656	73	706849	74	707025	75	707197	79	707353	85	707520	114	707758	112	707854	88
706671	128	706850	74	707026	75	707198	79	707383	87	707521	114	707759	112	707855	88
706678	90	706851	74	707027	75	707199	79	707393	86	707522	114	707760	84	707856	88
706679	90	706852	74	707028	75	707200	79	707435	84	707523	114	707761	84	707857	88
706680	90	706853	74	707029	75	707201	79	707436	83	707524	114	707762	84	707858	88
706681	90	706854	74	707030	75	707202	79	707437	83	707525	114	707763	84	707859	88
706682	89	706855	74	707031	75	707203	79	707438	83	707526	114	707764	84	707860	88
706683	89	706856	74	707032	75	707204	79	707439	83	707527	114	707765	84	707861	88
706704	92	706857	74	707033	75	707205	79	707440	83	707528	114	707766	84	707901	93
706720	128	706858	74	707034	75	707206	79	707441	83	707529	114	707767	84	707905	106
706721	128	706859	74	707035	75	707207	79	707442	83	707530	114	707768	84	707907	92
706722	128	706860	74	707036	75	707208	79	707443	83	707531	114	707769	84	707908	92
706723	128	706861	74	707037	75	707209	79	707444	83	707532	114	707770	84	707909	92
706751	78	706862	74	707038	75	707210	79	707445	83	707533	114	707771	84	707910	92
706752	78	706866	82	707039	75	707211	79	707446	83	707534	114	707772	84	707911	92
706753	78	706868	81	707040	75	707212	79	707447	83	707535	114	707773	84	707912	92
706754	78	706869	78	707041	75	707213	79	707448	83	707536	114	707774	84	707914	92
706755	78	706870	78	707042	75	707214	79	707449	83	707537	114	707775	84	707915	92
706756	78	706871	78	707043	75	707215	79	707450	83	707559	115	707776	84	707916	92
706757	78	706872	78	707044	75	707216	79	707451	83	707560	115	707777	84	707918	92
706758	78	706873	78	707045	75	707217	79	707452	83	707561	115	707778	84	707919	92
706759	78	706883	74	707046	75	707218	79	707453	83	707562	115	707779	84	707920	92
706760	78	706884	74	707047	75	707219	79	707454	83	707563	115	707780	84	707921	92
706761	78	706885	74	707048	75	707220	79	707455	83	707564	115	707781	84	707922	92
706762	78	706886	74	707049	75	707221	79	707456	83	707565	115	707782	84	707923	92
706763	78	706887	74	707050	75	707222	79	707457	83	707566	115	707783	84	707925	92
706764	78	706888	74	707051	75	707223	79	707458	83	707567	115	707784	84	707926	92
706765	78	706889	74	707052	75	707224	79	707459	83	707568	115	707785	84	707932	93
706766	78	706890	74	707053	75	707225	79	707460	83	707569	115	707786	84	707939	88
706767	78	706891	74	707054	75	707226	79	707461	83	707573	113	707787	84	707940	88
706768	78	706892	74	707055	75	707227	79	707462	83	707574	113	707788	84	707941	88
706769	78	706893	74	707056	75	707228	80	707463	83	707575	113	707788	84	707942	88
706770	78	706894	74	707057	75	707229	80	707464	83	707576	113	707814	88	707943	88
706771	78	706895	74	707058	75	707230	80	707465	83	707577	115	707815	88	707944	88
706772	78	706896	74	707059	75	707231	80	707466	83	707579	113	707816	88	707945	88
706777	80	706901	81	707060	75	707317	79	707467	83	707580	113	707817	88	707946	88
706778	80	706902	81	707061	75	707320	83	707468	83	707622	113	707818	88	707947	88
706779	78	706910	81	707062	75	707321	83	707470	84	707623	113	707819	88	707949	88
706780	78	706911	81	707063	75	707322	83	707471	113	707624	113	707820	88	707950	88
706781	78	706912	81	707064	75	707323	83	707472	113	707636	114	707821	88	707951	88
706782	78	706914	81	707106	85	707324	83	707473	113	707637	114	707822	88	707952	88
706783	78	706915	81	707107	86	707325	83	707474	113	707724	114	707823	88	707953	88
706784	78	706916	81	707108	86	707326	83	707475	113	707727	112	707824	88	707954	88
706785	78	706917	81	707110	86	707327	83	707476	113	707728	112	707825	88	707955	88
706786	78	706918	81	707111	86	707328	83	707477	113	707729	112	707826	88	707956	88
706787	78	706919	81	707112	86	707329	83	707479	113	707730	112	707827	88	707957	88
706788	78	706920	81	707113	86	707330	83	707490	113	707731	112	707828	88	707957	88
706789	78	706921	81	707114	86	707331	83	707491	113	707732	112	707829	88	707958	88
706790	78	706922	81	707116	86	707332	83	707492	113	707733	112	707830	88	707959	88
706791	78	706930	81	707117	87	707333	83	707493	113	707735	112	707831	88	707960	88
706792	78	706932	81	707118	86	707334	83	707494	113	707736	112	707832	88	707961	88
706793	78	706934	82	707119	87	707335	83	707496	114	707737	112	707833	88	707962	88
706794	78	706935	109	707120	86	707336	83	707497	114	707738	112	707834	88	707963	88
706797	78	706955	82	707122	86	707337	83	707498	114	707739	112	707835	88	707964	88
706798	78	706956	82	707123	87	707338	83	707499	114	707740	112	707837	88	707965	88
706799	78	706958	82	707124	87	707339	83	707500	114	707742	112	707838	88	707966	88
706800	78	706966	82	707127	87	707340	83	707501	114	707743	112	707839	88	707967	88
706801	78	706972	82	707129	87	707341	83	707502	114	707745	112	707840	88	707968	88
706802	78	706973	81	707179	86	707342	83	707503	114	707746	112	707841	88	707969	88
706820	79	706977	80	707180	86	707343	83	707504	114	707747	112	707842	88	707970	88
706821	79	706979	82	707183	86	707344	83	707505	114	707748	112	707843	88	707971	88
706822	79	706981	80	707186	86	707345	83	707506	114	707749	112	707844	88	707972	88
706823	79	706986	81	707189	85	707346	83	707507	114	707750	112	707845	88	707973	88
706824	79	706990	80	707190	85	707347	83	707508	114	707751	112	707846	88	707974	88
706825	79	706993	80	707192	86	707348	83	707509	114	707753	112	707847	88	707975	88
706842	81	706995	80	707193	79	707349	83	707510	114	707754	112	707848	88	707993	93
706846	74	707022	75	707194	79	707350	83	707511	114	707755	112	707849	88	707997	93
706847	74	707023	75	707195	79	707351	83	707518	114	707756	112	707850	88	707998	91
												707851	88	708003	92
												707852	88		

# INDEX - Item Code

708006	91	708180	85	708444	118	708839	103	708935	106	709598	63	710784	338	800483	214
708012	91	708181	85	708448	122	708841	103	708936	106	709642	79	710787	338	800484	207
708014	91	708182	85	708506	118	708842	103	708937	106	709728	62	710788	338	800485	207
708015	93	708183	85	708507	118	708848	103	708969	106	709730	63	710789	338	800486	338
708017	93	708184	85	708509	118	708850	103	708970	106	709732	62	710790	338	800487	338
708029	91	708185	85	708510	118	708851	105	708971	106	709734	62	710792	338	800488	338
708094	89	708186	85	708513	122	708852	105	708972	106	709736	62	710793	338	800489	338
708095	89	708187	85	708517	118	708858	105	708973	106	709739	62	710794	338	800490	338
708096	89	708188	85	708518	118	708859	105	708974	106	709742	62	710796	338	800491	338
708097	89	708189	85	708519	118	708860	102	708975	106	709744	63	710797	338	800492	338
708098	89	708190	85	708520	118	708861	102	708976	106	709746	62	710801	329	800493	338
708099	89	708191	85	708524	122	708862	102	708977	106	709748	62	710808	338	800496	304
708100	89	708192	85	708543	118	708863	102	708978	106	709750	63	710817	333	800497	304
708101	89	708193	85	708546	118	708864	102	708979	106	709755	63	710823	333	800587	302
708102	89	708194	85	708546	118	708865	102	708980	106	709757	63	710824	297	800588	302
708103	89	708195	85	708566	121	708865	102	708981	106	709764	63	710830	335	800589	302
708104	89	708196	85	708567	121	708866	102	708982	106	709766	63	710831	335	800605	322
708105	89	708197	85	708568	121	708867	102	708983	106	709914	234	710832	335	800650	97
708106	89	708198	85	708569	121	708868	102	708984	106	709915	234	710834	335	800651	97
708107	89	708199	85	708570	121	708872	102	708985	106	709940	233	710835	338	800652	97
708108	89	708236	94	708578	121	708874	102	708986	106	709947	233	710836	338	800653	97
708109	89	708237	94	708579	121	708876	99	708986	106	709948	233	710836	338	800654	97
708110	89	708238	94	708580	121	708877	99	708987	106	709949	233	710847	332	800655	97
708111	89	708240	94	708581	121	708878	99	708988	106	709950	233	710848	332	800656	97
708112	89	708241	94	708582	121	708879	99	708989	106	709951	233	710850	332	800656	97
708113	90	708244	94	708588	121	708884	101	708990	106	709952	233	710851	336	800776	106
708114	90	708245	94	708589	121	708885	101	708991	106	709953	234	710852	337	800798	105
708115	90	708246	94	708590	121	708886	101	708992	106	709954	232	710853	336	801103	24
708116	90	708247	94	708591	121	708887	101	708993	106	709955	233	710855	337	801182	245
708117	90	708248	94	708592	121	708888	101	708994	106	709956	232	710856	336	801183	247
708118	90	708249	94	708598	121	708889	101	708995	106	709957	232	710857	337	801191	247
708119	90	708250	94	708599	121	708890	101	708996	106	709963	233	710858	336	801194	245
708120	90	708251	94	708600	121	708891	101	708997	106	709965	233	710859	337	801209	245
708121	90	708252	94	708601	121	708892	101	708998	106	709966	233	710860	338	801210	247
708123	90	708253	94	708602	121	708893	101	708999	106	709967	233	710861	338	801211	245
708130	89	708254	94	708606	119	708894	101	709073	106	709970	233	710862	336	801214	245
708131	89	708255	94	708607	119	708895	101	709074	106	709972	233	711567	296	801215	245
708132	89	708256	94	708633	120	708897	101	709075	106	709977	233	711877	322	801216	247
708133	89	708257	94	708634	120	708898	101	709077	106	710560	196	711888	320	801219	240
708134	89	708258	94	708636	120	708899	101	709082	105	710576	196	711924	300	801229	240
708137	90	708259	94	708637	120	708900	101	709083	105	710581	196	800036	334	801230	250
708149	90	708260	94	708638	120	708907	106	709084	105	710586	196	800037	334	801241	246
708150	90	708261	94	708652	122	708908	106	709086	105	710602	196	800038	334	801245	246
708151	90	708262	94	708654	122	708909	106	709090	92	710650	196	800039	334	801269	243
708152	90	708263	94	708655	120	708909	106	709095	86	710664	196	800040	337	801320	243
708153	90	708264	94	708674	119	708910	106	709166	108	710665	196	800041	330	801321	243
708154	90	708265	94	708675	119	708911	106	709167	108	710688	196	800042	330	801322	243
708155	90	708266	94	708677	119	708912	106	709168	108	710705	196	800043	330	801334	249
708156	90	708267	94	708679	119	708913	106	709169	108	710742	331	800047	334	801348	249
708157	90	708268	94	708680	119	708914	106	709170	108	710743	331	800049	336	801350	249
708159	90	708269	94	708686	122	708915	106	709172	109	710746	328	800073	322	801351	241
708160	90	708270	94	708697	119	708916	106	709173	109	710748	329	800108	330	801368	241
708161	90	708272	94	708698	119	708917	106	709174	109	710749	329	800252	302	801404	240
708162	90	708274	94	708702	119	708918	106	709175	109	710750	328	800287	236	801405	240
708163	90	708277	94	708703	119	708919	106	709176	109	710752	328	800312	236	801456	242
708164	90	708278	94	708708	123	708920	106	709177	109	710753	328	800313	236	801498	242
708165	90	708291	95	708708	123	708921	106	709199	109	710754	329	800314	236	801499	242
708166	89	708303	94	708743	119	708922	106	709370	95	710755	332	800315	236	801500	242
708167	89	708314	94	708744	119	708923	106	709374	95	710756	330	800316	236	801501	242
708170	85	708320	94	708755	119	708924	106	709376	95	710757	330	800317	236	801502	242
708171	85	708321	94	708757	123	708925	106	709378	95	710758	331	800318	236	801503	242
708172	85	708322	94	708765	120	708926	106	709395	126	710760	331	800319	236	801518	248
708173	85	708356	95	708773	120	708927	106	709396	126	710772	338	800373	306	801529	244
708174	85	708358	95	708774	120	708928	106	709397	126	710773	338	800374	306	801563	245
708175	85	708375	94	708777	123	708929	106	709398	126	710779	338	800375	306	801573	250
708176	85	708376	94	708778	123	708930	106	709399	126	710780	338	800376	306	900013	109
708177	85	708377	94	708779	123	708931	106	709400	126	710781	338	800457	335		
708178	85	708378	94	708780	123	708932	106	709596	63	710782	338	800481	211		
708179	85	708440	118	708781	123	708933	106	709597	63	710783	338	800482	213		
		708441	118	708781	123	708933	106								
		708443	118	708821	105	708934	106								
				708822	105										
				708823	105										

# INDEX - Part Number

01030005	78
01030006	78
01030007	78
01030008	78
01030009	78
01030010	78
01030011	78
01030012	78
01030013	78
01030014	78
01030055	78
01050003	79
01050004	79
01050005	79
01050006	79
01120003	79
01120004	79
01120005	79
01120006	79
01120008	79
01140006	78
01140007	78
01140008	78
01140009	78
01140010	78
01200008	85
01200009	85
01200010	85
01240005	78
01240006	78
01240007	78
01240008	78
01240009	78
01240010	78
01240011	78
01240012	78
01240013	78
01240014	78
01240055	78
01270004	79
01270005	79
01270006	79
01270007	79
01270008	79
01270010	79
01290001	80
01290002	80
01290003	80
01290004	80
01350008	79
01350009	79
01350010	79
01350015	79
01350020	79
01350025	79
01350027	79
01350030	79
01350040	79
01351008	79
01351009	79
01351010	79
01351015	79
01351020	79
01351025	79
01351027	79
01351030	79
01351040	79
01450004	79
01450005	79

01450006	79
01450007	79
01450008	79
01450009	79
01450010	79
01450012	79
01450014	79
01450016	79
01530010	78
01530012	78
01530014	78
01530016	78
01530018	78
01530020	78
01530022	78
01530024	78
01530028	78
01530032	78
01530034	78
01640010	78
01640012	78
01640014	78
01640016	78
01640018	78
01640020	78
01640022	78
01640024	78
01640028	78
01640032	78
01640034	78
02010007	83
02010008	83
02010009	83
02010010	83
02010011	83
02010012	83
02010013	83
02010014	83
02010015	83
02010016	83
02010017	83
02010018	83
02010019	83
02010020	83
02010021	83
02010022	83
02010024	83
02020008	83
02020010	83
02020011	83
02020012	83
02020013	83
02020014	83
02020015	83
02020016	83
02020017	83
02020018	83
02020019	83
02020021	83
02020022	83
02020208	83
02050003	84
02050004	84
02050005	84
02050006	84
02050007	84
02050008	84
02050010	84
02060005	84

02060006	84
02060008	84
02060010	84
02100009	84
02100010	84
02100015	84
02100020	84
02100025	84
02100027	84
02100030	84
02100040	84
02100045	84
02130018	84
02151004	84
02151005	84
02151006	84
02151208	84
02151210	84
02200011	85
02200012	85
02200013	85
02200014	85
02200015	85
02200016	85
02200017	85
02200018	85
02200019	85
02200020	85
02200021	85
02200022	85
02200023	85
02200024	85
02200025	85
02200026	85
02200027	85
02200028	85
02200030	85
02200032	85
02200034	85
02200036	85
02200040	85
02200041	85
02200042	85
02200046	85
02200050	85
02410016	83
02410020	83
02410022	83
02410024	83
02410028	83
02410032	83
02410034	83
02410035	83
02410036	83
02410038	83
02410040	83
02410042	83
02410044	83
02410046	83
02410048	83
02420016	83
02420020	83
02420024	83
02420028	83
02420032	83
02420034	83
02420035	83
02420036	83
02420038	83

02420040	83
02420042	83
02420044	83
02420046	83
02420048	83
02450008	84
02450009	84
02450010	84
02450012	84
02450014	84
02450016	84
02450020	84
02450024	84
02620016	83
02620020	83
02620024	83
02620028	83
02620032	83
03010008	88
03010009	88
03010010	88
03010011	88
03010012	88
03010013	88
03010014	88
03010015	88
03010016	88
03010017	88
03010018	88
03010019	88
03010020	88
03010021	88
03010022	88
03010023	88
03010024	88
03010025	88
03010026	88
03010027	88
03010028	88
03010030	88
03010031	88
03010032	88
03010034	88
03020010	88
03020013	88
03020014	88
03020015	88
03020016	88
03020017	88
03020018	88
03020019	88
03020021	88
03020022	88
03020024	88
03020026	88
03020027	88
03020030	88
03020032	88
03020208	88
03020216	88
03050004	89
03050005	89
03050006	89
03050007	89
03050008	89
03050010	89
03050012	89
03050014	89
03050017	89



# INDEX - Part Number

03050019	89
03060005	90
03060006	90
03060008	90
03060010	90
03060012	90
03060014	90
03060016	90
03090005	90
03090006	90
03090007	90
03090008	90
03090009	90
03090010	90
03090012	90
03090013	90
03090014	90
03090016	90
03100020	90
03100025	90
03100027	90
03100030	90
03100040	90
03100045	90
03100050	90
03100055	90
03100060	90
03131070	91
03131230	91
03131240	91
03131245	91
03131440	91
03131445	91
03131450	91
03131455	91
03131460	91
03150706	89
03150713	89
03150808	89
03151006	89
03151007	89
03151205	89
03151206	89
03151207	89
03151208	89
03151408	89
03151410	89
03151412	89
03151414	89
03151805	89
03152206	89
03160808	90
03161110	90
03161112	90
03161208	90
03261408	90
03261410	90
03261412	90
03261414	90
03280005	89
03280006	89
03280007	89
03280008	89
03280010	89
03310005	90
03310008	90
03410024	88
03410028	88
03410032	88

03410034	88
03410035	88
03410036	88
03410038	88
03410040	88
03410041	88
03410042	88
03410044	88
03410046	88
03410048	88
03410050	88
03410052	88
03410054	88
03410056	88
03410058	88
03410060	88
03410062	88
03410064	88
03420024	88
03420028	88
03420032	88
03420034	88
03420036	88
03420038	88
03420040	88
03420042	88
03420044	88
03420046	88
03420048	88
03420050	88
03420052	88
03420054	88
03420056	88
03420058	88
03420060	88
03420062	88
03420064	88
03450014	89
03450016	89
03450020	89
03450024	89
03450028	89
03450032	89
03450034	89
03450036	89
03450040	89
05010019	94
05010021	94
05010022	94
05010024	94
05010027	94
05010030	94
05010032	94
05010033	94
05010034	94
05010036	94
05010038	94
05010041	94
05010046	94
05010050	94
05010055	94
05010060	94
05050014	94
05050017	94
05050019	94
05050022	94
05410040	94
05410042	94
05410044	94

05410046	94
05410048	94
05410050	94
05410052	94
05410056	94
05410058	94
05410060	94
05410062	94
05410064	94
05410066	94
05410067	94
05410068	94
05410069	94
05410070	94
05410072	94
11010001	81
11010002	81
11010006	81
11010010	81
11010011	81
11010012	81
11010014	81
11010016	81
11010020	81
11010024	81
11011001	81
11011002	81
11020000	81
11030002	82
11030003	82
11030010	109
11040000	81
11050010	81
11051010	81
11061010	81
11070000	81
11100001	81
11110002	82
11110020	80
11110030	80
11111010	80
11180010	82
11260001	80
12010001	86
12010002	86
12010003	86
12010004	86
12010005	86
12010006	86
12010007	87
12010008	87
12010009	87
12011001	86
12011002	86
12011003	86
12020000	87
12030001	87
12030003	87
12061010	86
12070000	86
12110020	85
12110030	86
12111010	85
12231011	85
12250001	87
12260001	86
13010001	92
13010002	92
13010003	92

13010004	92
13010005	92
13010006	92
13010007	92
13010008	92
13011001	92
13011002	92
13011003	92
13011004	92
13020000	93
13021000	93
13030002	93
13030005	93
13061012	92
13061013	92
13070000	92
13071000	92
13110020	91
13110030	91
13111010	91
13210001	92
13260001	91
15030003	95
15030006	95
15060000	94
15070000	94
15110000	94
15170000	94
16060000	95
16070000	95
16110000	95
16170000	95
18120000	82
19010000	80
19011020	81
19020000	86
19020020	86
19040000	91
19040020	92
40030405	66
40030607	66
40030708	66
40030809	66
40030810	66
40031011	66
40031012	66
40031013	66
40031113	66
40031213	66
40031214	66
40031314	66
40031315	66
40031317	66
40031415	66
40031417	66
40031617	66
40031618	66
40031719	66
40031819	66
40031821	66
40031922	66
40032022	66
40032123	66
40032124	66
40032224	66
40032426	66
40032427	66
40032528	66
40032730	66

# INDEX - Part Number

40032732	66
40033032	66
40033034	66
40033236	66
40033436	66
40033641	66
40034146	66
40035507	66
40040240	74
40040270	74
40040300	74
40040320	74
40040360	74
40040410	74
40040460	74
40040500	74
40040550	74
40040600	74
40040650	74
40040700	74
40040750	74
40040800	74
40040850	74
40040900	74
40040950	74
40060404	69
40060505	69
40060606	69
40060707	69
40060808	69
40060909	69
40061010	69
40061111	69
40061212	69
40061313	69
40061414	69
40063232	69
40063535	69
40064545	69
40065555	69
40080606	67
40080707	67
40080808	67
40080909	67
40081010	67
40081111	67
40081212	67
40081313	67
40081414	67
40081515	67
40081616	67
40081717	67
40081818	67
40081919	67
40082020	67
40082121	67
40082222	67
40082323	67
40082424	67
40082525	67
40082626	67
40082727	67
40082828	67
40082929	67
40083030	67
40083232	67
40083434	67
40083636	67
40083838	67

40084141	67
40084646	67
40085050	67
40085500	67
40085555	67
40086060	67
40093232	70
40093535	70
40094040	70
40094545	70
40095050	70
40100606	68
40100707	68
40100808	68
40100909	68
40101010	68
40101111	68
40101212	68
40101313	68
40101414	68
40101515	68
40101616	68
40101717	68
40101818	68
40101919	68
40102020	68
40102121	68
40102222	68
40102424	68
40102727	68
40103030	68
40103232	68
40103434	68
40103636	68
40104141	68
40250004	74
40250006	74
40250008	74
40250010	74
40250012	74
40250015	74
40250018	74
40260004	74
40260006	74
40260008	74
40260010	74
40260012	74
40260015	74
40260018	74
40431620	66
40432024	66
40432428	66
40432832	66
40433234	66
40433436	66
40433538	66
40433638	66
40433640	66
40433840	66
40433842	66
40434044	66
40434142	66
40434446	66
40434648	66
40435258	66
40461010	69
40461212	69
40461313	69
40461414	69

40461515	69
40461616	69
40461818	69
40462020	69
40462222	69
40462424	69
40462828	69
40463232	69
40463434	69
40481212	67
40481313	67
40481414	67
40481515	67
40481616	67
40481818	67
40482020	67
40482222	67
40482424	67
40482828	67
40483232	67
40483434	67
40483535	67
40483636	67
40483838	67
40484040	67
40484141	67
40484242	67
40484444	67
40484646	67
40484848	67
40485050	67
40485252	67
40485454	67
40485656	67
40485858	67
40486060	67
40486262	67
40486464	67
40486666	67
40486969	67
40487070	67
40487272	67
41040607	70
41040809	70
41040810	70
41041011	70
41041013	70
41041213	70
41041317	70
41041415	70
41041617	70
41041719	70
41041819	70
41041821	70
41041922	70
41042022	70
41042123	70
41042124	70
41042224	70
41042426	70
41042427	70
41042528	70
41042730	70
41042732	70
41043032	70
41043034	70
41043436	70
41043641	70
41044650	70

41050607	71
41050809	71
41050810	71
41051011	71
41051213	71
41051317	71
41051415	71
41051617	71
41051719	71
41051819	71
41051821	71
41051922	71
41052022	71
41052124	71
41052427	71
41052732	71
41053032	71
41053034	71
41070607	71
41070809	71
41071011	71
41071213	71
41071415	71
41071617	71
41071719	71
41071819	71
41072022	71
41072123	71
41072427	71
41073032	71
41080810	72
41080911	72
41081011	72
41081012	72
41081113	72
41081214	72
41081417	72
41081719	72
41081922	72
41082224	72
41082427	72
41082736	72
41083032	72
41091012	73
41091113	73
41091416	73
41091417	73
41091517	73
41091618	73
41091922	73
41100808	72
41101010	72
41101111	72
41101212	72
41101313	72
41101414	72
41101616	72
41101717	72
41101818	72
41101919	72
41130708	73
41130910	73
41131011	73
41131213	73
41131415	73
41131618	73
41131719	73
41250608	72
41251012	72

# INDEX - Part Number

41251418	72
41252024	72
41441620	70
41442428	70
41443234	70
41443436	70
41443538	70
41443640	70
41443842	70
41444044	70
41444142	70
41444446	70
41444648	70
41445258	70
41481620	72
41482024	72
41482428	72
41483234	72
41483640	72
41484048	72
41561620	73
41562022	73
41562428	73
41563234	73
41563638	73
41564044	73
41564246	73
41611620	71
41612022	71
41612024	71
41612428	71
41612832	71
41613234	71
41613436	71
41613640	71
41613840	71
41614244	71
41614648	71
41614850	71
41615256	71
42050024	75
42050026	75
42050027	75
42050028	75
42050030	75
42050032	75
42050033	75
42050036	75
42050037	75
42050038	75
42050041	75
42050042	75
42050046	75
42050047	75
42050048	75
42050050	75
42050052	75
42050055	75
42050056	75
42050060	75
42050064	75
42050065	75
42050070	75
42050075	75
42050080	75
42050085	75
42050090	75
42050095	75
42050100	75

42050105	75
42050110	75
42050115	75
42050120	75
42050130	75
42050135	75
42050145	75
42050150	75
42050160	75
42050165	75
42050170	75
42050175	75
42050180	75
42050210	75
43010809	73
43011011	73
43011013	73
43011213	73
43011415	73
43011617	73
43011618	73
43011719	73
43011819	73
43012022	73
43012123	73
43012427	73
43150002	116
43150003	116
43150004	116
43150005	116
43150006	116
43150007	116
43150008	116
43150009	116
43150010	116
43150011	116
43150012	116
43150014	116
43150017	116
43150019	116
43150022	116
43150024	116
43150027	116
43150030	116
43150032	116
43150036	116
43150070	116
43150090	116
43150130	116
43150150	116
43150250	116
43150350	116
43232060	115
43232070	115
43232080	115
43232090	115
43232100	115
43232110	115
43232120	115
43232130	115
43250020	116
43250025	116
43250030	116
43250040	116
43250050	116
43250060	116
43250080	116
43250100	116
43252020	116

43252025	116
43252030	116
43252040	116
43252050	116
43252060	116
43252080	116
43252100	116
43260002	116
43260003	116
43260004	116
43260005	116
43260006	116
43260008	116
43260010	116
43260012	116
43260015	116
43260025	116
43290008	116
43290009	116
43290010	116
43290015	116
43290020	116
43290025	116
43290027	116
43290030	116
43290040	116
43290045	116
43290050	116
43320607	74
43320809	74
43321011	74
43321213	74
43321415	74
43321617	74
43321719	74
43321819	74
43322022	74
43322123	74
43322426	74
43322427	74
43323032	74
43323236	74
43323641	74
43324146	74
43324650	74
43325560	74
43412428	73
43413234	73
43413638	73
43570130	116
44010001	127
44010002	127
44010003	127
46201035	113
46201040	113
46201055	113
46201065	113
46201080	113
46201100	113
46201120	113
46221055	113
46221065	113
46221080	113
46221100	113
46221120	113
46221140	113
46281025	114
46281035	114
46281040	114

46281055	114
46282035	114
46282055	114
46301000	114
46301001	114
46301002	114
46301003	114
46311001	114
46311002	114
46321001	114
46321002	114
46321003	114
46321004	114
46401000	114
46401001	114
46401002	114
46401003	114
46501006	114
46501007	114
46501008	114
46501009	114
46501010	114
46501015	114
46501020	114
46501025	114
46501027	114
46501030	114
46501040	114
46501045	114
46501115	114
46501120	114
46501125	114
46501130	114
46601025	115
46601030	115
46601035	115
46601040	115
46601055	115
46601065	115
46601080	115
46651000	115
46651001	115
46651002	115
46651003	115
47241045	113
47241060	113
47241080	113
47341001	114
47341002	114
48201035	112
48201040	112
48201065	112
48201080	112
48201100	112
48202055	112
48202100	112
48301000	112
48301001	112
48301002	112
48301003	112
48301004	112
48401001	112
48401002	112
48560006	112
48560007	112
48560008	112
48560009	112
48560010	112
48560015	112

# INDEX - Part Number

48560020	112
48560025	112
48560027	112
48560030	112
48560040	112
50180002	102
50180004	102
50180005	102
50180010	102
50180012	102
50180020	102
50180040	102
50180065	102
50180080	102
50181002	101
50181005	101
50181010	101
50181012	101
50181020	101
50181040	101
50181065	101
50200005	103
50200015	103
50200030	103
50200081	103
50580002	102
50580004	102
50581002	101
50581005	101
50581010	101
50581020	101
50581040	101
52100022	109
52100026	109
52100028	109
52100029	109
52101023	109
52102023	109
52110051	109
58211007	106
58211008	106
58211009	106
58211010	106
58211011	106
58211012	106
58211013	106
58211014	106
58211015	106
58211016	106
58211017	106
58211018	106
58211019	106
58214013	106
58214014	106
58214015	106
58214016	106
58214017	106
58214018	106
58214019	106
58214021	106
58214022	106
58214024	106
58214025	106
58214027	106
58214030	106
58214032	106
58214034	106
58214036	106
58214038	106

58214041	106
58221007	106
58221008	106
58221010	106
58221011	106
58221012	106
58221013	106
58221014	106
58221015	106
58221016	106
58221017	106
58221018	106
58221019	106
58221021	106
58221022	106
58224013	106
58224014	106
58224015	106
58224016	106
58224017	106
58224018	106
58224019	106
58224021	106
58224022	106
58224024	106
58224027	106
58224028	106
58224030	106
58224032	106
58224034	106
58224036	106
58224041	106
58240005	106
58240010	106
58240020	106
58240040	106
58240065	106
58250005	105
58250010	105
58250020	105
58250040	105
58250065	105
58253004	105
58253005	105
58253010	105
58253020	105
58521087	109
59010011	106
59251005	86
59251020	92
65015180	118
65015200	118
65016180	118
65016200	118
65018200	122
65295160	118
65295200	118
65296160	118
65296200	118
65298200	122
65305160	118
65305200	118
65306160	118
65306200	118
65308200	122
65345280	118
65355280	118
65436000	121
65436001	121

65436002	121
65436003	121
65436004	121
65446001	121
65446011	121
65446021	121
65446031	121
65446041	121
65456000	121
65456001	121
65456002	121
65456003	121
65456004	121
65466001	121
65466011	121
65466021	121
65466031	121
65466041	121
65516240	119
65516300	119
65632175	120
65632250	120
65642175	120
65642250	120
65642300	120
65751220	122
65751280	122
65765231	120
66005160	119
66005180	119
66006160	119
66006180	119
66008180	122
66025200	119
66025250	119
66026200	119
66026250	119
66028200	123
66185160	119
66186160	119
66226160	119
66228160	123
66307220	120
66601250	120
66601280	120
70010005	124
70010006	124
70010008	124
70010010	124
70010012	124
70020002	124
70020003	124
70020004	124
70020005	124
70020007	124
70020008	124
70050001	125
70050002	125
70050005	125
70080001	124
70080002	124
70090001	125
70090002	125
70090003	125
70090004	125
70090005	125
70090006	125
70090007	125
70090008	125

70110001	124
70110002	124
70110003	124
70110004	124
70110005	124
70110006	124
70110007	124
70110008	124
70120001	124
70120002	124
70120003	124
70120004	124
70120005	124
70120006	124
70160027	124
70160032	124
70160035	124
70160040	124
70160050	124
71310001	126
71310002	126
71310003	126
71310004	126
71310005	126
72060101	125
72060103	125
72060104	125
72060105	125
72080103	125
72210000	125
72210002	125
72230001	126
73010001	127
73210102	127
73272001	115
73272002	115
73272003	115
73272004	115
73282012	115
73282023	115
74010400	128
74010600	128
74010602	128
74010603	128
74160001	127
74240001	128
74240002	128
74240005	128
74270005	127
74310001	127
74370001	128
77070000	127
77090000	126
77090010	126
77100000	126
77250000	126
77260025	127
77260027	127
77260060	127
77260200	127
77270003	126
77380001	127
77390001	126
77390002	126
77401030	127
77401040	127
77401050	127
77401060	127
77401103	127

# INDEX - Part Number

77440001	128
77450001	115
77460001	126
77470001	126
79040035	124
79040040	124
79040050	124
79160001	124
79180002	125
80400001	80
80400002	80
80450001	85
80450002	85
83400306	66
83400601	66
83404601	66
83410704	66
91228214	82
91288238	87
91338212	93
96010162	82
96010304	82
96021001	84
96022702	84
96030508	89
96031004	90
96034125	93
96050104	95
96190800	92
96400305	66
96400306	66
96400307	66
96400312	66
96400313	66
96400651	69
96400653	69
96400801	68
96400802	68
96400803	68
96400804	68
96400805	68
96400808	68
96400813	68
96400816	68
96400902	70
96401004	69
96401005	69
96401006	69
96401007	69
96401008	69
96401009	69
96401010	69
96404306	66
96404307	66
96404654	69
96404803	68
96404804	68
96404812	68
96410405	70
96410406	70
96410407	70
96410408	70
96410409	70
96410501	72
96410503	72
96410704	71
96411001	73
96414402	70
96414405	70

96430101	73
96431201	74
96431204	74
96431501	115
96432101	115
96432601	116
96432602	116
96435501	115
96435502	115
96435701	116
96435702	116
96469110	113
96469210	113
96469310	113
96469410	113
96469510	115
96469710	113
96469910	113
96479710	114
96489110	112
96489210	112
96489910	112
96500901	97
96500902	97
96500904	97
96500906	97
96500910	97
96500920	97
96500940	97
96501606	105
96501620	105
96501640	105
96501710	99
96501720	99
96501740	99
96501765	99
96502001	103
96502105	101
96502110	101
96502120	101
96502140	101
96521072	108
96521080	108
96521082	108
96521083	108
96521084	108
96650005	123
96650006	123
96650007	123
96650008	123
96700701	125
96700702	125
96700711	125
96713025	126
96722801	126
96830164	68
96830174	68
96838171	72
96838184	112
98812201	125
98812202	125
AAA100/1220-040	5
AAA100/1220-060	5
AAA100/1220-080	5
AAA100/915-040	5
AAA100/915-060	5
AAA100/915-080	5
AAA100/915-100	5
AAA100/915-120	5

AAA100/915-150	5
AAA100/915-180	5
AAA100/915-240	5
AAA100/915-320	5
AAA25/610-040	4
AAA25/610-060	4
AAA25/610-080	4
AAA25/610-120	4
AAA25/610-180	4
AAA50/1220-040	5
AAA50/1220-060	5
AAA50/1220-080	5
AAA50/1220-100	5
AAA50/1220-120	5
AAA50/1220-150	5
AAA50/1220-240	5
AAA50/1220-400	5
AAA50/915-040	4
AAA50/915-060	4
AAA50/915-080	4
AAA50/915-100	4
AAA50/915-120	4
AAA50/915-150	4
AAA50/915-180	4
AAA50/915-240	4
AAA50/915-320	4
AAA50/915-400	4
AABPV/150	6
AABPV/175	6
AABPV/225	6
AABPV/300	6
AACOMGREEN	6
AACOMGREENBL	6
AACOMGREY	6
AACOMGREYBL	6
AACOMRED	6
AACOMREDBL	6
AACOMWHITE	6
AACOMWHITEBL	6
AADSA175/040	5
AADSA175/060	5
AADSA175/080	5
AADSA175/100	5
AADSA175/120	5
AADV175/040	6
AADV175/060	6
AADV175/080	6
AADV175/100	6
AADV175/120	6
AAGWA25/150-36	8
AAGWA25/150-60	8
AAGWA25/200-36	8
AAGWA25/200-60	8
AAGWS25/150	8
AAGWS25/200	8
AAMOP100/1	7
AAMOP150/1	7
AAMOP200/1	7
AAMOPB150/2	7
AAMOPB150/3	7
AAMOPB150/4	7
AAMOPB200/2	7
AAMOPB200/3	7
AAMOPB200/4	7
AAMOPBST150/1	7
AAMOPBST150/2	7
AAMOPBST150/4	7
AAMOPBST200/1	7
AAMOPBST200/2	7

AAMOPBST200/4	7
AAMOPST100/1	7
AAMOPST150/1	7
AAMOPST200/1	7
AAPACK50/915150	4
AAPACK50/915240	4
AAPACK50/91540	4
AAPACK50/915400	4
AAPACK50/915-5	4
AAPACK50/915-80	4
AAPACKDSA175-4	5
AAPACKSCB	5
AAPACKVEL175040	6
AAPACKVEL175060	6
AAPACKVEL175080	6
AAPACKVEL175100	6
AAPACKVEL175-5	6
AASCB50/915FP	4
AASCB50/915M	4
AASCB50/915P	4
AASTIK	7
AATBE/150LJM	8
AATBE/150LM	8
AATBE/150RJM	8
AATBE/150RM	8
AATBE/200LM	8
AATBE/200RM	8
AAWB/150	8
AAWB/200	8
ATBG280/6	2
ATBG600/8	2
ATBG600/8WBM	2
ATBG930/10	2
ATBGU/6	2
ATBGU/8	2
ATBM280/6	2
ATCAP13MF	3
ATCAP5MF	3
ATES6	3
ATES8	3
ATPED-HDK	3
ATSW6/8NEW	3
ATTR8A	3
AVA 2901	236
AVA CS6 TG LH	236
AVA CS6 TG RH	236
AVA CS66 TC RH	236
AVA CS6TCLH	236
AVA CSJ5 TC LH	236
AVA CSJ5 TC RH	236
AVA CSJ5 TG LH	236
AVA CSJ5 TG RH	236
BIA-2HP15A	303
BIA-2HP15AH-A	304
BIA-2HP20A	305
BIA-AHS05A	300
BIA-AHS10A	300
BIA-B120G	302
BIA-B15A	301
BIA-B15VA	301
BIA-B25A	301
BIA-B25VA	301
BIA-B40A	301
BIA-B40VA	301
BIA-B42A	300
BIA-B42AMPCX	296
BIA-B75A	301
BIA-B75KA	302
BIA-B75VA	301

# INDEX - Part Number

BIA-BLC120-110	303
BIA-BLC120-185	303
BIA-BLC200-110	303
BIA-BLC200-185	303
BIA-BLC70-055	303
BIA-BLC70-075	303
BIA-BLC70-100	303
BIA-DHKIT	297
BIA-DHP15	305
BIA-DHP20	305
BIA-DHP20E	305
BIA-FFHK	304
BIA-FSK1	297
BIA-FSK1-20	297
BIA-FTB50	304
BIA-HP15A	303
BIA-HP15AH-C	304
BIA-INOX120PC	296
BIA-INOX60PC	296
BIA-INOX80PC	296
BIA-JH400	298
BIA-JH40011	298
BIA-JH550B	299
BIA-JH554	299
BIA-JH554B	299
BIA-JH754BM	299
BIA-JH754M	299
BIA-JH8003P	300
BIA-JH900	298
BIA-LAYFLATKIT	300
BIA-MULTI1300PC	296
BIA-MULTI900PC	296
BIA-PDG150M	302
BIA-PDG150MA	302
BIA-PDG150T	302
BIA-PDG150TA	302
BIA-Q550B	299
BIA-SERIES250-B120G	306
BIA-SERIES250-B40A	306
BIA-SERIES250-B40VA	306
BIA-SERIES250-B75KA	306
BIA-SHKIT	297
BIA-SHP50	305
BIA-SK12(10M)	297
BIA-SK12(20M)	297
BIA-SK12(30M)	297
BIA-SK12(5M)	297
BIA-SK12CWB	297
BIA-SK6	297
BIA-SK9A	297
BIA-SKIT6	297
BIA-TECH40PC	296
BIA-TF2500	305
BIA-TSHKITA	297
BIA-WB80	304
BIA-WP10AA	304
BIA-WP20A	303
BIA-WP30A	303
BIA-ZA01-20B	298
BIA-ZW03-20B	298
BIA-ZW08-30B	298
CHWX1001	294
CHWX801700DI	294
CHWX8019	294
ESHR165FM	238
ESHR30MM	238
ESHR50MM	238
ESM100FM	238
ESM10MM	238

ESM20MM	238
ESM30MM	238
ESR100MM	238
ESZ3NGC	238
EVO-BLADE185-DMND	284
EVO-BLADE230-AL	282
EVO-BLADE230-SS	282
EVO-BLADE230-ST	282
EVO-BLADE255-DMND	285
EVO-BLADE255M	285
EVO-BLADE355/66-ST	282
EVO-BLADE355/80-AL	282
EVO-BLADE355/90-SS	282
EVO-BLADE355-DMND	282, 284
EVO-BLADE355M	284
EVO-BLADE-RAGE185M	284
EVO-CUTTERKIT/S	283
EVO-CYCLONE	283
EVO-EXTREME230	282
EVO-EXTREME230-P	282
EVO-HTA47	283
EVO-MD42	283
EVO-RAGE	284
EVO-RAGE2	284
EVO-RAGE3	285
EVO-RAGE3DB	285
EVO-RAPTOR355	282
EVO-RAPTOR355-P	282
EW10-10	37
EW12-12	37
EW16-16	37
EW22E	39
EW3	42
EW4	42
EW45E	39
EW5	36
EWB3-2LB	39
EWB3-3LB	39
EWB3-4LB	39
EWB3-4LBL	39
EWBP-10	37
EWBP-12	37
EWBP-14	37
EWBP-16	37
EWE12C	38
EWE14A	36
EWE15C	41
EWE15CR	38
EWE19S	41
EWE20C	38
EWE24A	36
EWE24C	38
EWE30	42
EWE3-11	40
EWE3-14P	42
EWE3-16BP	38
EWE3-16C	39
EWE3-20BLC	38, 42
EWE3-20C	39
EWE3-20S	41
EWE3-22P	42
EWE3-22S	40
EWE3-22SM	40
EWE3-23LP	42
EWE3-24BLC	38, 42
EWE3-24BP	38
EWE3-25S	41
EWE3-28C-24	39

EWE3-28S	40
EWE3-28SM	40
EWE3-2H	36
EWE3-32BP	38
EWE3-FF4	36
EWE3-WC	38
EWE44A	36
EWE45A	36
EWE-5	42
EWE6-22BLC	38
EWE6-22T	41
EWE6-22TM	41
EWE6-40CP	39
EWE6-48E	40
EWERC-12C	37
EWERC-7C	37
EWERC-9C	37
EWWEB-12	37
EWWEB-18	37
EWWEB-24	37
EWWEB-30	37
EWWEB-36	37
EWGP100	42
EWHB-15	36
EWHC-10	36
EWMP250G	37
EWMP300G	37
EWPB-18	36
EWPC210G	37
EWPC250G	37
EWPC280G	37
EWPC300G	37
EWPC360G	37
EWRS	36
EWSHF12LB	41
FH10MK11C	28
FH20	29
FH20-6/4	29
FH20-6/5	29
FH20-6/6	29
FH20-7/4	29
FH20-7/5	29
FH20-7/6	29
FH2448	28
FH2464	28
FH40	29
FH44	28
FH60	29
FH64	28
FHRIVM10LFS	29
FHRIVM12LFS	29
FHRIVM4LFS	29
FHRIVM5LFS	29
FHRIVM6LFS	29
FHRIVM8LFS	29
FLB1.1N	52
FLB500N	52
FLB700N	52
FLB900N	52
FLBB	54
FLBH	52
FLBS	53
FLC1.8N	52
FLCANEKNIFE	54
FLCH	52
FLCH4	52
FLHK	54
FLHW	53
FLLHMS	54

FLLHMS/S	54
FLMACHETE	54
FLRM32	52
FLS1.8N	52
FLS1.8NC	53
FLS3.6CW	53
FLS3.6S	52
FLS3.6SC	53
FLS3.6SS	53
FLS4.5S	52
FLS4.5SS	53
FLS6.3S	52
FLS6.3SC	53
FLS6.3SS	53
FLSH	53
FLSH6.3	53
FLSHC	53
FLSLG/1.8WH	52
FLSLG/3.6WH	52
FLSLG/4.5WH	52
FLSLG/6.3WH	52
FLSMH	54
GEN11	206
GEN120	211
GEN125	211
GEN146	208
GEN1478C	208
GEN147C	208
GEN151	211
GEN16ME	206
GEN17	206
GEN1700	210
GEN1702	207
GEN18	206
GEN29	207
GEN300MM	206
GEN4	206
GEN450-6	208
GEN452-6	208
GEN454-6	208
GEN500	210
GEN505	214
GEN55	206
GEN557	212
GEN60004	214
GEN700540	211
GEN70396	214
GEN70401	214
GEN70403	214
GEN70408	214
GEN707476	214
GEN709555	212
GEN72	211
GEN729ME	209
GEN750542	211
GEN750544	211
GEN751016	210
GEN75622	213
GEN759570	212
GEN759582	214
GEN77	208
GEN80	209
GEN800543	211
GEN80075	210
GEN80560	212
GEN8075X	210
GEN822	207
GEN825	206
GEN828	207

# INDEX - Part Number

GEN836	209
GEN837	210
GEN842	210
GEN86014	210
GEN87	208
GEN88CM	209
GEN88P	209
GEN950-5	211
GENDAF3010B	212
GENDCS300	213
GENDCS400	213
GENDMM830HS	213
GENIRT207	212
GENMG1001MMC	209
GENMG1002MMC	209
GENMG6001C	209
GENMG8001C	209
GENMGDC150C	209
GENMGDC200C	209
GENMMD4E	212
GENPNG2000A	213
GENPTH8707	213
JF27/1	216
JF27/2	216
JF27/3	216
JFBD152/13	216
JFBD152/19	216
JFBD152/25	216
JFBD152/9.5	216
JFBD203/25	216
JFBD292/19	216
JFBD292/25	216
JFP010	216
JFP014	216
JFP03	216
JFP04	216
JFP05	216
JFP08	216
KO100H3203	132
KO100H3204	132
KO100H3205	132
KO100H3206	132
KO100H3208	132
KO100H3210	132
KO100H3212	132
KO100H3214	132
KO100P32/1	132
KO100P32/2	132
KO100P32/3	132
KO100P32/4	132
KO100P80/1	132
KO100P80/2	132
KO100P80/3	132
KO100P80/4	132
KO100S3206	132
KO100S3208	132
KO100S3209	132
KO100S3211	132
KO100S3212	132
KO100S3214	132
KO100S8006	132
KO100S8007	132
KO100S8008	132
KO100S8009	132
KO100S8011	132
KO100S8012	132
KO100T35T10	132
KO100T35T15	132
KO100T35T20	132

KO100T35T25	132
KO100T35T27	132
KO100T35T30	132
KO100T35T40	132
KO104A12	131
KO104A14	131
KO104A16	131
KO104A18	131
KO104A20	131
KO104A24	131
KO104M06	131
KO104M07	131
KO104M08	131
KO104M09	131
KO104M10	131
KO104M11	131
KO104M12	131
KO104M13	131
KO104M14	131
KO104M15	131
KO104M17	131
KO104M18	131
KO104M19	131
KO104M21	131
KO104M22	131
KO106-8S×10S	167
KO10711M05	177
KO10711M06	177
KO10711M08	177
KO10711M10	177
KO10711M19	177
KO10716M10	182
KO10716M12	182
KO10716M14	182
KO10716M17	182
KO10716M19	182
KO10716M22	182
KO10716T55	182
KO10716T60	182
KO10716T70	182
KO10722M19	183
KO10722M22	183
KO10722M24	183
KO10722M27	183
KO10722T100	183
KO10722T80	183
KO10722T90	183
KO110050	139
KO110100	139
KO110150	139
KO112050	151
KO112100	151
KO12400A08	174
KO12400M06	174
KO12400M07	174
KO12400M08	174
KO12400M10	174
KO12400M12	174
KO12770P	174
KO1301A	175
KO1301B	175
KO1301C	175
KO1302A	175
KO1302B	175
KO1302C	175
KO13241M	175
KO13300A08	174
KO13300A10	174
KO13300A12	174

KO13300A14	174
KO13300A16	174
KO13300A18	174
KO13300A20	174
KO13300A22	174
KO13300A24	174
KO13300A26	174
KO13300A28	174
KO13300M06	174
KO13300M07	174
KO13300M08	174
KO13300M09	174
KO13300M10	174
KO13300M11	174
KO13300M12	174
KO13300M13	174
KO13300M14	174
KO13300M15	174
KO13300M16	174
KO13300M17	174
KO13300M18	174
KO13300M19	174
KO13300M20	174
KO13300M21	174
KO13300M22	174
KO13344A	175
KO13400A08	174
KO13400A10	174
KO13400A12	174
KO13400A14	174
KO13400A16	174
KO13400A18	174
KO13400A20	174
KO13400A22	174
KO13400A24	174
KO13400A26	174
KO13400A28	174
KO13400M06	174
KO13400M07	174
KO13400M08	174
KO13400M09	174
KO13400M10	174
KO13400M11	174
KO13400M12	174
KO13400M13	174
KO13400M14	174
KO13400M15	174
KO13400M16	174
KO13400M17	174
KO13400M18	174
KO13400M19	174
KO13400M21	174
KO13400M22	174
KO13400M23	174
KO13400M27	174
KO13400M29	174
KO13400M30	174
KO13400M31	174
KO13400M32	174
KO13400MG10	175
KO13760075	175
KO13760125	175
KO13760250	175
KO13770	175
KO1401A	179
KO1401B	179
KO1402A	179
KO1402B	179
KO14101MP17110	178
KO14101MP1775	178
KO14101MP1795	178
KO14101MP19120	178
KO14101MP1960	178
KO14101MP1990	178

KO14101MP21100	178
KO14101MP21120	178
KO14105	177
KO14118A2426	178
KO14118M1921	178
KO14118M1922	178
KO14118M2122	178
KO14124/3	178
KO14145PM17	178
KO14145PM19	178
KO14145PM21	178
KO14200A10	180
KO14200M11	180
KO14201M	178
KO14203M	177
KO14241A	180
KO14241M	180
KO14300A10	176
KO14300A12	176
KO14300A14	176
KO14300A16	176
KO14300A18	176
KO14300A20	176
KO14300A22	176
KO14300A24	176
KO14300A26	176
KO14300A28	176
KO14300A30	176
KO14300A32	176
KO14300A34	176
KO14300A36	176
KO14300A40	176
KO14300M08	176
KO14300M09	176
KO14300M10	176
KO14300M11	176
KO14300M12	176
KO14300M13	176
KO14300M14	176
KO14300M15	176
KO14300M16	176
KO14300M17	176
KO14300M18	176
KO14300M19	176
KO14300M21	176
KO14300M22	176
KO14300M23	176
KO14300M24	176
KO14300M26	176
KO14300M27	176
KO14300M29	176
KO14300M30	176
KO14300M31	176
KO14300M32	176
KO14300M34	176
KO14300M36	176
KO14300M41	176
KO14301M17	177
KO14400A10	176
KO14400A12	176
KO14400A14	176
KO14400A16	176
KO14400A18	176
KO14400A19	176
KO14400A20	176
KO14400A22	176
KO14400A24	176
KO14400A26	176
KO14400A28	176

# INDEX - Part Number

KO14400A30	176
KO14400A32	176
KO14400A34	176
KO14400A36	176
KO14400A38	176
KO14400A40	176
KO14400M06	176
KO14400M08	176
KO14400M09	176
KO14400M10	176
KO14400M11	176
KO14400M12	176
KO14400M13	176
KO14400M14	176
KO14400M15	176
KO14400M16	176
KO14400M17	176
KO14400M18	176
KO14400M19	176
KO14400M20	176
KO14400M21	176
KO14400M22	176
KO14400M23	176
KO14400M24	176
KO14400M26	176
KO14400M27	176
KO14400M28	176
KO14400M29	176
KO14400M30	176
KO14400M32	176
KO14400M36	176
KO14400M41	176
KO14433A	177
KO14433A-B	177
KO14466A	178
KO14466A-B	178
KO145LH3/8F-105	167
KO14760050	177
KO14760075	177
KO14760125	177
KO14760150	177
KO14760225	177
KO14760250	177
KO14770	177
KO14770-B	177
KO1600C-10	184
KO1601A	184
KO1601B	184
KO16106	182
KO16106-16M10	182
KO16106-16M14	182
KO16106-16M17	182
KO16106-16M19	182
KO16106-16M22	182
KO16107	183
KO16107-22M24	182
KO16107-22M27	182
KO16200A8	185
KO16200M6	185
KO16204AM	182
KO16205M	183
KO16300A24	181
KO16300A26	181
KO16300A28	181
KO16300A30	181
KO16300A32	181
KO16300A34	181
KO16300A36	181
KO16300A38	181

KO16300A40	181
KO16300A42	181
KO16300A44	181
KO16300A46	181
KO16300A48	181
KO16300A50	181
KO16300A52	181
KO16300A54	181
KO16300A56	181
KO16300A58	181
KO16300A60	181
KO16300A64	181
KO16300M19	181
KO16300M20	181
KO16300M21	181
KO16300M22	181
KO16300M23	181
KO16300M24	181
KO16300M25	181
KO16300M26	181
KO16300M27	181
KO16300M28	181
KO16300M29	181
KO16300M30	181
KO16300M31	181
KO16300M32	181
KO16300M33	181
KO16300M34	181
KO16300M35	181
KO16300M36	181
KO16300M37	181
KO16300M38	181
KO16300M41	181
KO16300M42	181
KO16300M46	181
KO16300M50	181
KO16301M17	182
KO16301M24	182
KO16301M27	182
KO16301M30	182
KO16301M32	182
KO16301M33	182
KO16316M3517	184
KO16316M3820	184
KO16316M4119	184
KO16316M4121	184
KO16317M17	184
KO16317M19	184
KO16317M20	184
KO16317M21	184
KO16317M22	184
KO16400A22	181
KO16400A24	181
KO16400A26	181
KO16400A28	181
KO16400A30	181
KO16400A32	181
KO16400A34	181
KO16400A36	181
KO16400A38	181
KO16400A40	181
KO16400A42	181
KO16400A44	181
KO16400A46	181
KO16400A48	181
KO16400A50	181
KO16400A52	181
KO16400A54	181
KO16400A56	181

KO16400A58	181
KO16400A60	181
KO16400A62	181
KO16400A64	181
KO16400A66	181
KO16400A68	181
KO16400A70	181
KO16400A72	181
KO16400A74	181
KO16400A76	181
KO16400M17	181
KO16400M18	181
KO16400M19	181
KO16400M20	181
KO16400M21	181
KO16400M22	181
KO16400M23	181
KO16400M24	181
KO16400M25	181
KO16400M26	181
KO16400M27	181
KO16400M28	181
KO16400M29	181
KO16400M30	181
KO16400M31	181
KO16400M32	181
KO16400M33	181
KO16400M34	181
KO16400M35	181
KO16400M36	181
KO16400M38	181
KO16400M41	181
KO16400M42	181
KO16400M46	181
KO16400M50	181
KO16400M54	181
KO16400M55	181
KO16400M56	181
KO16400M58	181
KO16400M60	181
KO16644A	183
KO16688A	184
KO166P1	130
KO166P2	130
KO166P3	130
KO166PS/6	130
KO16655	130
KO16656	130
KO16658	130
KO16760175	183
KO16760250	183
KO16760330	183
KO16770	183
KO16771	183
KO167M03	131
KO167M03.5	131
KO167M04	131
KO167M04.5	131
KO167M05	131
KO167M05.5	131
KO167M06	131
KO167M07	131
KO167M08	131
KO167M10	131
KO167M12	131
KO167M13	131
KO167M14	131
KO168P1	130
KO168P2	130

KO168P3	130
KO168PS/6	130
KO16855	130
KO16856	130
KO16858	130
KO168T/7	130
KO168T-T10H	130
KO168T-T15H	130
KO168T-T20H	130
KO168T-T25H	130
KO168T-T27H	130
KO168T-T30H	130
KO168T-T40H	130
KO1801A	187
KO1801B	187
KO1801C-10	187
KO18300A28	186
KO18300A30	186
KO18300A32	186
KO18300A34	186
KO18300A36	186
KO18300A38	186
KO18300A40	186
KO18300A42	186
KO18300A44	186
KO18300A46	186
KO18300A48	186
KO18300A50	186
KO18300A52	186
KO18300A54	186
KO18300A56	186
KO18300A58	186
KO18300A60	186
KO18300A62	186
KO18300A64	186
KO18300A66	186
KO18300A68	186
KO18300A70	186
KO18300A72	186
KO18300A74	186
KO18300A76	186
KO18300A78	186
KO18300A80	186
KO18300M22	186
KO18300M23	186
KO18300M24	186
KO18300M25	186
KO18300M26	186
KO18300M27	186
KO18300M28	186
KO18300M29	186
KO18300M30	186
KO18300M31	186
KO18300M32	186
KO18300M33	186
KO18300M34	186
KO18300M35	186
KO18300M36	186
KO18300M38	186
KO18300M41	186
KO18300M42	186
KO18300M46	186
KO18300M48	186
KO18300M50	186
KO18300M52	186
KO18300M55	186
KO18300M60	186
KO18300M65	186
KO18300M70	186



# INDEX - Part Number

KO18400A026	185
KO18400A028	185
KO18400A030	185
KO18400A032	185
KO18400A034	185
KO18400A036	185
KO18400A038	185
KO18400A040	185
KO18400A042	185
KO18400A044	185
KO18400A046	185
KO18400A048	185
KO18400A050	185
KO18400A052	185
KO18400A054	185
KO18400A056	185
KO18400A058	185
KO18400A060	185
KO18400A062	185
KO18400A064	185
KO18400A066	185
KO18400A068	185
KO18400A070	185
KO18400A072	185
KO18400A074	185
KO18400A076	185
KO18400A078	185
KO18400A080	185
KO18400A082	185
KO18400A084	185
KO18400A086	185
KO18400A088	185
KO18400A090	185
KO18400A092	185
KO18400A094	185
KO18400A096	185
KO18400A098	185
KO18400A100	185
KO18400A104	185
KO18400A108	185
KO18400A112	185
KO18400M21	185
KO18400M22	185
KO18400M23	185
KO18400M24	185
KO18400M25	185
KO18400M26	185
KO18400M27	185
KO18400M28	185
KO18400M29	185
KO18400M30	185
KO18400M31	185
KO18400M32	185
KO18400M33	185
KO18400M34	185
KO18400M35	185
KO18400M36	185
KO18400M38	185
KO18400M40	185
KO18400M41	185
KO18400M42	185
KO18400M45	185
KO18400M46	185
KO18400M50	185
KO18400M52	185
KO18400M55	185
KO18400M60	185
KO18400M63	185
KO18400M65	185

KO18400M70	185
KO18400M75	185
KO18400M80	185
KO18400M85	185
KO18400M90	185
KO18760175	186
KO18760200	186
KO18760250	186
KO18760330	186
KO18770	186
KO18866A	186
KO18877A	187
KO2000/1	135
KO2000/2	135
KO2000/3	135
KO2010M03	135
KO2010M04	135
KO2010M05	135
KO2010M06	135
KO2010M07	135
KO2010M08	135
KO2010M10	135
KO2137	138
KO2201AW	139
KO2201M	139
KO2233A	138
KO2251A	139
KO2257M	139
KO2260M	140
KO2261M	140
KO2274AD	135
KO2274MD	135
KO2276	140
KO2277	140
KO2300A04	134
KO2300A06	134
KO2300A07	134
KO2300A08	134
KO2300A09	134
KO2300A10	134
KO2300A11	134
KO2300A12	134
KO2300A14	134
KO2300A16	134
KO2300A18	134
KO2300M03	134
KO2300M04	134
KO2300M05	134
KO2300M06	134
KO2300M07	134
KO2300M08	134
KO2300M09	134
KO2300M10	134
KO2300M11	134
KO2300M12	134
KO2300M13	134
KO2300M14	134
KO2305A04	134
KO2305A06	134
KO2305A07	134
KO2305A08	134
KO2305A09	134
KO2305A10	134
KO2305A11	134
KO2305A12	134
KO2305A14	134
KO2305A16	134
KO2305A18	134
KO2305M03	134

KO2305M04	134
KO2305M05	134
KO2305M06	134
KO2305M07	134
KO2305M08	134
KO2305M09	134
KO2305M10	134
KO2305M11	134
KO2305M12	134
KO2305M13	134
KO2305M14	134
KO2400A04	133
KO2400A06	133
KO2400A07	133
KO2400A08	133
KO2400A09	133
KO2400A10	133
KO2400A11	133
KO2400A12	133
KO2400A14	133
KO2400A16	133
KO2400A18	133
KO2400M03	133
KO2400M04	133
KO2400M04.5	133
KO2400M05	133
KO2400M05.5	133
KO2400M06	133
KO2400M07	133
KO2400M08	133
KO2400M09	133
KO2400M10	133
KO2400M11	133
KO2400M12	133
KO2400M13	133
KO2400M14	133
KO2405A04	133
KO2405A06	133
KO2405A07	133
KO2405A08	133
KO2405A09	133
KO2405A10	133
KO2405A11	133
KO2405A12	133
KO2405A14	133
KO2405A16	133
KO2405A18	133
KO2405M03	133
KO2405M04	133
KO2405M04.5	133
KO2405M05	133
KO2405M05.5	133
KO2405M06	133
KO2405M07	133
KO2405M08	133
KO2405M09	133
KO2405M10	133
KO2405M11	133
KO2405M12	133
KO2405M13	133
KO2405M14	133
KO2415M06	134
KO2415M08	134
KO2415M10	134
KO2445A08	135
KO2445A10	135
KO2445A12	135
KO2445A14	135
KO2445A16	135

KO2445A18	135
KO2715	138
KO2749N-3/8	146
KO2749RK	137
KO2753J	136
KO2753JB	136
KO2753N	136
KO2753P	136
KO2753P-160	136
KO2753PB	136
KO2753PS	136
KO2753RK	137
KO2755	137
KO2756	137
KO2760050	137
KO2760100	137
KO2760150	137
KO2760250	137
KO2760400	137
KO2760600	137
KO2762	137
KO2763028	137
KO2763050	137
KO2763075	137
KO2763100	137
KO2768	138
KO2768P	138
KO2769F	138
KO2769N150	138
KO2770	138
KO2774J	136
KO2774JS-3/8	147
KO2774P	136
KO2780	138
KO2785	138
KO3010M6203	144
KO3010M6204	144
KO3010M6205	144
KO3010M6207	144
KO3010M6208	144
KO3010M6210	144
KO3010M6212	144
KO3012A5204	145
KO3012A5205	145
KO3012A5206	145
KO3012A5207	145
KO3012A5208	145
KO3012A5209	145
KO3012A5210	145
KO3012A5211	145
KO3012A5212	145
KO3012A5214	145
KO3012A5216	145
KO3012A5218	145
KO3012M5203	145
KO3012M5204	145
KO3012M5205	145
KO3012M5206	145
KO3012M5207	145
KO3012M5208	145
KO3012M5209	145
KO3012M5210	145
KO3012M5211	145
KO3012M5212	145
KO3012M5213	145
KO3012M5214	145
KO3012M7504	145
KO3012M7505	145
KO3012M7506	145

# INDEX - Part Number

KO3012M7508	145
KO3012M7510	145
KO3025-38T10	144
KO3025-38T15	144
KO3025-38T20	144
KO3025-38T25	144
KO3025-38T27	144
KO3025-38T30	144
KO3025-38T40	144
KO3025-38T45	144
KO3025-50TH10	145
KO3025-50TH15	145
KO3025-50TH20	145
KO3025-50TH25	145
KO3025-50TH27	145
KO3025-50TH30	145
KO3025-50TH40	145
KO3025-50TH45	145
KO3025-50TH50	145
KO3025T10	144
KO3025T15	144
KO3025T20	144
KO3025T25	144
KO3025T27	144
KO3025T30	144
KO3025T40	144
KO3025T45	144
KO3025T50	144
KO3025T55	144
KO3127M08	151
KO3127M09	151
KO3127M10	151
KO3127M11	151
KO3127M12	151
KO3127M13	151
KO3127M14	151
KO3127M15	151
KO3127M16	151
KO3127M17	151
KO3137	151
KO3138	132
KO3201AMW	152
KO3206AM	153
KO3206M	152
KO3210M	153
KO3215A	143
KO3217A	153
KO3217M	153
KO3217MS	153
KO3220M	153
KO3225A	153
KO3229	152
KO3275	154
KO3276	154
KO3277	154
KO3300A08	142
KO3300A10	142
KO3300A12	142
KO3300A14	142
KO3300A16	142
KO3300A18	142
KO3300A20	142
KO3300A22	142
KO3300A24	142
KO3300A26	142
KO3300A28	142
KO3300C14	152
KO3300C16	152
KO3300C18	152

KO3300C20.8	152
KO3300M/4-120	143
KO3300M06	142
KO3300M07	142
KO3300M08	142
KO3300M08L120	143
KO3300M09	142
KO3300M10	142
KO3300M10L120	143
KO3300M11	142
KO3300M12	142
KO3300M12L120	143
KO3300M13	142
KO3300M14	142
KO3300M14L120	143
KO3300M15	142
KO3300M16	142
KO3300M17	142
KO3300M18	142
KO3300M19	142
KO3300M21	142
KO3300M22	142
KO3300M23	142
KO3300M24	142
KO3300S16	152
KO3300S18	152
KO3300S20.8	152
KO3305A08	143
KO3305A10	143
KO3305A12	143
KO3305A14	143
KO3305A16	143
KO3305A18	143
KO3305A20	143
KO3305A22	143
KO3305A24	143
KO3305A26	143
KO3305A28	143
KO3305M06	143
KO3305M07	143
KO3305M08	143
KO3305M09	143
KO3305M10	143
KO3305M11	143
KO3305M12	143
KO3305M13	143
KO3305M14	143
KO3305M15	143
KO3305M16	143
KO3305M17	143
KO3305M18	143
KO3305M19	143
KO3305M21	143
KO3305M22	143
KO3305M23	143
KO3305M24	143
KO3305P14	152
KO3322A	150
KO3344A	150
KO3350M/5	144
KO3400A08	141
KO3400A10	141
KO3400A11	141
KO3400A12	141
KO3400A14	141
KO3400A16	141
KO3400A18	141
KO3400A19	141
KO3400A20	141

KO3400A22	141
KO3400A24	141
KO3400A25	141
KO3400A26	141
KO3400A28	141
KO3400M06	141
KO3400M07	141
KO3400M08	141
KO3400M09	141
KO3400M10	141
KO3400M11	141
KO3400M12	141
KO3400M13	141
KO3400M14	141
KO3400M15	141
KO3400M16	141
KO3400M17	141
KO3400M18	141
KO3400M19	141
KO3400M20	141
KO3400M21	141
KO3400M22	141
KO3400M23	141
KO3400M24	141
KO3405A08	141
KO3405A10	141
KO3405A11	141
KO3405A12	141
KO3405A14	141
KO3405A16	141
KO3405A18	141
KO3405A19	141
KO3405A20	141
KO3405A22	141
KO3405A24	141
KO3405A25	141
KO3405A26	141
KO3405A28	141
KO3405M06	141
KO3405M07	141
KO3405M08	141
KO3405M09	141
KO3405M10	141
KO3405M11	141
KO3405M12	141
KO3405M13	141
KO3405M14	141
KO3405M15	141
KO3405M16	141
KO3405M17	141
KO3405M18	141
KO3405M19	141
KO3405M20	141
KO3405M21	141
KO3405M22	141
KO3405M23	141
KO3405M24	141
KO3405W04	142
KO3405W06	142
KO3405W08	142
KO3405W10	142
KO3405W12	142
KO3405W14	142
KO3405W16	142
KO3425E10	142
KO3425E11	142
KO3425E12	142
KO3425E14	142
KO3425E16	142

KO3425E4	142
KO3425E5	142
KO3425E6	142
KO3425E7	142
KO3425E8	142
KO3445A12	144
KO3445A14	144
KO3445A16	144
KO3445A18	144
KO3445M10	144
KO3445M11	144
KO3445M12	144
KO3445M13	144
KO3445M14	144
KO3445M15	144
KO3445M16	144
KO3445M17	144
KO3445M19	144
KO3450M/8	142
KO3715	151
KO3715SL	151
KO3716	151
KO3749N	146
KO3749S	146
KO3749S-1/2	159
KO3752N	146
KO3752RK	148
KO3753N	147
KO3753P	147
KO3753P-250	147
KO3753RK	148
KO3753SM	146
KO3755	148
KO3756	148
KO3757	148
KO3760032	148
KO3760050	148
KO3760075	148
KO37601000	148
KO3760125	148
KO3760150	148
KO3760250	148
KO3760400	148
KO3760600	148
KO3760900	148
KO3762	148
KO3763032	149
KO3763050	149
KO3763075	149
KO3763125	149
KO3763150	149
KO3763250	149
KO3768175	149
KO3768250	149
KO3768P250	149
KO3768P380	149
KO3769H	150
KO3769N-160	149
KO3770	150
KO3771	150
KO3774J	147
KO3774N	147
KO3774NL	148
KO3774P	147
KO3774PB	147
KO3774PS	147
KO3775	148
KO3776J	146
KO3776N	146

# INDEX - Part Number

KO3776P	146
KO3780	150
KO3785	150
KO4012A/10-L60	165
KO4012A6005	159
KO4012A6006	159
KO4012A6008	159
KO4012A6010	159
KO4012A6012	159
KO4012A6014	159
KO4012A6016	159
KO4012A6018	159
KO4012A6020	159
KO4012A6024	159
KO4012M/10-L60	165
KO4012M6004	159
KO4012M6005	159
KO4012M6006	159
KO4012M6007	159
KO4012M6008	159
KO4012M6009	159
KO4012M6010	159
KO4012M6012	159
KO4012M6014	159
KO4012M6015	159
KO4012M6016	159
KO4012M6017	159
KO4012M6019	159
KO4012M6021	159
KO4012M6022	159
KO4012M6024	159
KO4020-60/M10	158
KO4020-60/M12	158
KO4020-60/M14	158
KO4020-60/M16	158
KO4020-60/M18	158
KO4020-60/M5	158
KO4020-60/M6	158
KO4020-60/M8	158
KO4020-60/MH16	164
KO4025-60T20	158
KO4025-60T25	158
KO4025-60T27	158
KO4025-60T30	158
KO4025-60T40	158
KO4025-60T45	158
KO4025-60T50	158
KO4025-60T55	158
KO4025-60T60	158
KO4100A08	163
KO4100A10	163
KO4100A12	163
KO4100A14	163
KO4100A16	163
KO4100A18	163
KO4100A20	163
KO4100M06	163
KO4100M07	163
KO4100M08	163
KO4100M09	163
KO4100M10	163
KO4100M10.5	163
KO4100M11	163
KO4100M12	163
KO4100M14	163
KO4100M16	163
KO4101/1	164
KO4101/2	164
KO4101/3	164

KO4127M14	164
KO4127M17	164
KO4127M19	164
KO4127M21	164
KO4127M22	164
KO4127M24	164
KO4127M25.4	164
KO4128L120M19	164
KO4128L120M21	164
KO4138	132
KO4202	167
KO4211A	163
KO4211M	163
KO4214M	163
KO4239AM	165
KO4239AMP	165
KO4241M	165
KO4251A	165
KO4251M	165
KO4251M-6P	165
KO4267W	165
KO4274AMW	166
KO4279AM	166
KO4282	167
KO4300A10	156
KO4300A12	156
KO4300A14	156
KO4300A16	156
KO4300A18	156
KO4300A19	156
KO4300A20	156
KO4300A21	156
KO4300A22	156
KO4300A24	156
KO4300A25	156
KO4300A26	156
KO4300A28	156
KO4300A30	156
KO4300A32	156
KO4300A34	156
KO4300A36	156
KO4300A38	156
KO4300A40	156
KO4300M08	156
KO4300M09	156
KO4300M10	156
KO4300M11	156
KO4300M12	156
KO4300M13	156
KO4300M14	156
KO4300M15	156
KO4300M16	156
KO4300M17	156
KO4300M18	156
KO4300M19	156
KO4300M20	156
KO4300M21	156
KO4300M22	156
KO4300M23	156
KO4300M24	156
KO4300M25	156
KO4300M26	156
KO4300M27	156
KO4300M28	156
KO4300M29	156
KO4300M30	156
KO4300M31	156
KO4300M32	156
KO4300M-L110/17	164

KO4300M-L110/19	164
KO4300M-L110/21	164
KO4300S16	164
KO4300S18	164
KO4300S20.6	164
KO4305A10	157
KO4305A12	157
KO4305A14	157
KO4305A16	157
KO4305A18	157
KO4305A19	157
KO4305A20	157
KO4305A21	157
KO4305A22	157
KO4305A24	157
KO4305A25	157
KO4305A26	157
KO4305A28	157
KO4305A30	157
KO4305A32	157
KO4305A34	157
KO4305A36	157
KO4305A38	157
KO4305A40	157
KO4305M08	157
KO4305M09	157
KO4305M10	157
KO4305M11	157
KO4305M12	157
KO4305M13	157
KO4305M14	157
KO4305M15	157
KO4305M16	157
KO4305M17	157
KO4305M18	157
KO4305M19	157
KO4305M20	157
KO4305M21	157
KO4305M22	157
KO4305M23	157
KO4305M24	157
KO4305M25	157
KO4305M26	157
KO4305M27	157
KO4305M28	157
KO4305M29	157
KO4305M30	157
KO4305M31	157
KO4305M32	157
KO4305M34	157
KO4305M36	157
KO4325E10	157
KO4325E12	157
KO4325E14	157
KO4325E16	157
KO4325E18	157
KO4325E20	157
KO4400A10	155
KO4400A12	155
KO4400A14	155
KO4400A16	155
KO4400A18	155
KO4400A19	155
KO4400A20	155
KO4400A21	155
KO4400A22	155
KO4400A24	155
KO4400A25	155
KO4400A26	155

KO4400A28	155
KO4400A30	155
KO4400A32	155
KO4400A34	155
KO4400A36	155
KO4400A38	155
KO4400A40	155
KO4400A42	155
KO4400A44	155
KO4400A46	155
KO4400A48	155
KO4400M08	155
KO4400M09	155
KO4400M10	155
KO4400M11	155
KO4400M12	155
KO4400M13	155
KO4400M14	155
KO4400M15	155
KO4400M16	155
KO4400M17	155
KO4400M18	155
KO4400M19	155
KO4400M20	155
KO4400M21	155
KO4400M22	155
KO4400M23	155
KO4400M24	155
KO4400M25	155
KO4400M26	155
KO4400M27	155
KO4400M28	155
KO4400M29	155
KO4400M30	155
KO4400M31	155
KO4400M32	155
KO4400M33	155
KO4400M34	155
KO4400M35	155
KO4400M36	155
KO4405A10	155
KO4405A12	155
KO4405A14	155
KO4405A16	155
KO4405A18	155
KO4405A19	155
KO4405A20	155
KO4405A21	155
KO4405A22	155
KO4405A24	155
KO4405A25	155
KO4405A26	155
KO4405A28	155
KO4405A30	155
KO4405A32	155
KO4405A34	155
KO4405A36	155
KO4405A38	155
KO4405A40	155
KO4405A42	155
KO4405A44	155
KO4405A46	155
KO4405A48	155
KO4405M07	155
KO4405M08	155
KO4405M09	155
KO4405M10	155
KO4405M11	155
KO4405M12	155

# INDEX - Part Number

KO4405M13	155
KO4405M14	155
KO4405M15	155
KO4405M16	155
KO4405M17	155
KO4405M18	155
KO4405M19	155
KO4405M20	155
KO4405M21	155
KO4405M22	155
KO4405M23	155
KO4405M24	155
KO4405M25	155
KO4405M26	155
KO4405M27	155
KO4405M28	155
KO4405M29	155
KO4405M30	155
KO4405M31	155
KO4405M32	155
KO4405M33	155
KO4405M34	155
KO4405M35	155
KO4405M36	155
KO4405M38	155
KO4405W04	156
KO4405W06	156
KO4405W08	156
KO4405W10	156
KO4405W12	156
KO4405W14	156
KO4405W16	156
KO4405W18	156
KO4405W20	156
KO4405W22	156
KO4405W24	156
KO4405W28	156
KO4425E10	156
KO4425E12	156
KO4425E14	156
KO4425E16	156
KO4425E18	156
KO4425E20	156
KO4425E24	156
KO4433A35	163
KO4445A12	157
KO4445A14	157
KO4445A16	157
KO4445A18	157
KO4445A20	157
KO4445A22	157
KO4466A	163
KO4715	164
KO4747	162
KO4749N-250	159
KO4749N-380	159
KO4749RK	161
KO4750P	159
KO4750PB	160
KO4752N	160
KO4753N	160
KO4753NB	160
KO4753P	160
KO4753P-410	160
KO4753RK	161
KO4755	161
KO4760050	162
KO4760075	162
KO4760100	162

KO47601000	162
KO4760125	162
KO4760250	162
KO4760400	162
KO4760500	162
KO4760600	162
KO4763050	162
KO4763075	162
KO4763125	162
KO4763150	162
KO4763250	162
KO4768J600	161
KO4768N300	161
KO4768N380	161
KO4768N450	161
KO4768N600	161
KO4768P380	161
KO4768P600	161
KO4768RK	161
KO4770	161
KO4771	161
KO4774N	160
KO4774P	160
KO4774P-450	160
KO4780400	162
KO4780450	162
KO4785	162
KO6012M14	168
KO6012M17	168
KO6012M19	168
KO6012M22	168
KO6012M24	168
KO6012M27	168
KO6101	170
KO6201A	170
KO6201M	170
KO6212M	170
KO6260A	171
KO6260M	171
KO6290A	171
KO6290M	171
KO6305A24	169
KO6305A26	169
KO6305A28	169
KO6305A30	169
KO6305A32	169
KO6305A34	169
KO6305A36	169
KO6305A38	169
KO6305A40	169
KO6305A42	169
KO6305A44	169
KO6305A46	169
KO6305A48	169
KO6305A50	169
KO6305A52	169
KO6305A54	169
KO6305A56	169
KO6305A64	169
KO6305A66	169
KO6305A68	169
KO6305A70	169
KO6305A72	169
KO6305A74	169
KO6305A76	169
KO6305A78	169
KO6305A80	169
KO6305M17	169
KO6305M19	169

KO6305M20	169
KO6305M21	169
KO6305M22	169
KO6305M23	169
KO6305M24	169
KO6305M25	169
KO6305M26	169
KO6305M27	169
KO6305M28	169
KO6305M29	169
KO6305M30	169
KO6305M31	169
KO6305M32	169
KO6305M33	169
KO6305M34	169
KO6305M35	169
KO6305M36	169
KO6305M38	169
KO6305M40	169
KO6305M41	169
KO6305M42	169
KO6305M43	169
KO6305M44	169
KO6305M46	169
KO6305M50	169
KO6305M53	169
KO6305M54	169
KO6305M55	169
KO6305M57	169
KO6305M58	169
KO6305M60	169
KO6305M63	169
KO6405A22	168
KO6405A24	168
KO6405A25	168
KO6405A26	168
KO6405A28	168
KO6405A30	168
KO6405A32	168
KO6405A34	168
KO6405A36	168
KO6405A38	168
KO6405A40	168
KO6405A42	168
KO6405A44	168
KO6405A46	168
KO6405A48	168
KO6405A50	168
KO6405A52	168
KO6405A54	168
KO6405A56	168
KO6405A58	168
KO6405A60	168
KO6405A62	168
KO6405A64	168
KO6405A66	168
KO6405A68	168
KO6405A70	168
KO6405A72	168
KO6405A74	168
KO6405A76	168
KO6405A78	168
KO6405A80	168
KO6405M17	168
KO6405M18	168
KO6405M19	168
KO6405M20	168
KO6405M21	168
KO6405M22	168

KO6405M23	168
KO6405M24	168
KO6405M25	168
KO6405M26	168
KO6405M27	168
KO6405M28	168
KO6405M29	168
KO6405M30	168
KO6405M31	168
KO6405M32	168
KO6405M33	168
KO6405M34	168
KO6405M35	168
KO6405M36	168
KO6405M37	168
KO6405M38	168
KO6405M39	168
KO6405M40	168
KO6405M41	168
KO6405M42	168
KO6405M43	168
KO6405M44	168
KO6405M45	168
KO6405M46	168
KO6405M47	168
KO6405M48	168
KO6405M50	168
KO6405M52	168
KO6405M54	168
KO6405M55	168
KO6405M56	168
KO6405M57	168
KO6405M58	168
KO6405M60	168
KO6405M63	168
KO6405M70	168
KO6644A	170
KO6688A	170
KO67491000	169
KO6749550	169
KO6755	169
KO6760075	169
KO6760200	169
KO6760400	169
KO6768	169
KO67681000	169
KO6768600	169
KO6770	170
KO6785	170
KO6788	170
KO8200A	173
KO8200M	173
KO8225M	173
KO8290A	173
KO8405A100	172
KO8405A104	172
KO8405A112	172
KO8405A34	172
KO8405A40	172
KO8405A42	172
KO8405A44	172
KO8405A46	172
KO8405A48	172
KO8405A50	172
KO8405A52	172
KO8405A54	172
KO8405A56	172
KO8405A58	172
KO8405A60	172

# INDEX - Part Number

KO8405A64	172
KO8405A66	172
KO8405A68	172
KO8405A70	172
KO8405A72	172
KO8405A74	172
KO8405A76	172
KO8405A78	172
KO8405A80	172
KO8405A82	172
KO8405A84	172
KO8405A86	172
KO8405A88	172
KO8405A90	172
KO8405A92	172
KO8405A94	172
KO8405A96	172
KO8405M27	172
KO8405M32	172
KO8405M33	172
KO8405M35	172
KO8405M36	172
KO8405M38	172
KO8405M40	172
KO8405M41	172
KO8405M46	172
KO8405M50	172
KO8405M54	172
KO8405M55	172
KO8405M58	172
KO8405M60	172
KO8405M63	172
KO8405M65	172
KO8405M67	172
KO8405M70	172
KO8405M71	172
KO8405M75	172
KO8405M80	172
KO8749	172
KO8760200	172
KO8760400	172
KO8768	173
KO8770	172
KO8785	173
KO8866A	172
KOAG112A	131
KOAN112A	131
KOAN112C	131
KOKP14101/6H	179
KOKP1401C-10	179
KOKP1402C-10	179
KOKP2346/6	150
KOKP2760/6	137
KOKP2763/6	137
KOKP3760/6	149
KOKP3763/6	149
KOKP4760/5	162
KOKP4763/5	162
KORS14012M60/10	177
KORS14401M/10	176
KORS2010A/8-L25	135
KORS2010M/7-L100	135
KORS2010M/7-L25	135
KORS2025/7(PR)	135
KORS2025/7-L28	135
KORS2300A/9	134
KORS2300M/11	134
KORS2305A/9	134
KORS2305M/11	134

KORS2400A/9	133
KORS2400M/11	133
KORS2400W/9	133
KORS2405A/9	133
KORS2405M/11	133
KORS2445A/9	135
KORS3010M/8-38	144
KORS3010M/8-62	144
KORS3010M8-L100	144
KORS3012A52/8	146
KORS3012M52/8	146
KORS3025/8	145
KORS3025/8-L100R	145
KORS3025/9(PR)	145
KORS3025/9TP	145
KORS3129/6-L32	151
KORS3129/6-L60	151
KORS3300A/9	142
KORS3300M/12	142
KORS3300W/7	143
KORS3305A/9	142
KORS3305M/12	142
KORS3325/9	143
KORS3400A/9	141
KORS3400M/12	141
KORS3405A/9	141
KORS3405M/12	141
KORS3425/9	142
KORS3440A/8	144
KORS3440M/8	144
KORS4010M75/10	158
KORS4012A60/10	159
KORS4012M60/10	159
KORS4020/6-L60	158
KORS4025/9	158
KORS4025/9-IP	158
KORS4027/6-L60	158
KORS4300A/10	157
KORS4300M/10	157
KORS4305A/10	157
KORS4305M/10	157
KORS4400A/10	156
KORS4400M/10	156
KORS4405M/10	156
KORS4425/7	156
KORSAS2405A/10	133
KOST4027.140	167
MA1000/005	203
MA1000/006	203
MA1000/008	203
MA1000/010	203
MA1000/016	203
MA1000/020	203
MA1000/025	203
MA1000/032	203
MA1000/04	203
MA1000/05	203
MA1000/125	203
MA1001/05	203
MA1001/438	203
MA1001/750	203
MA1001/875	203
MA1700/001	203
MA1700/500	203
MA1774	203
MA2230/200	202
MA2233-200	202
MA2990/160	202
MA3010/150	202

MA3015/150	202
MA4866/160	202
MA4870/125	202
MA4870/140	202
MA4870/160	202
MA4871/140	202
MA4950/200	202
MA4951/140	202
MA4951/160	202
MA4960/200	202
MENBB2(1)D	22
MENBB4D	22
MENBB5D	22
MENBB6D	22
MENBB8D	22
MENBCO4(3)D	22
MENBCO6D	22
MENBCO8D	22
MENBCP10D	22
MENBCP10D-E	22
MENBCP2(1)D	22
MENBCP4D	22
MENBCP4D-E	22
MENBCP5D	22
MENBCP5D-E	22
MENBCP6A	23
MENBCP6D	22
MENBCP6D-E	22
MENBCP7D-E	22
MENBCP8A	23
MENBCP8D	22
MENBCP8D-E	22
MENBCR10D	22
MENBCR4A	23
MENBCR4D	22
MENBCR5D	22
MENBCR6A	23
MENBCR6D	22
MENBCR8A	23
MENBCR8D	22
MENBF10D	22
MENBF5D	22
MENBF8D	22
MENBOV4A	23
MENBOV4D	22
MENBOV6D	22
MENBOV8D	22
MENBT10D	22
MENBT4D	22
MENBT5D	22
MENBT6D	22
MENBT8A	23
MENBT8D	22
MENBTOOL13	24
MENBTP6D	23
MENBTP8(2)D	23
MENBTR10D	23
MENBTR4D	23
MENBTR6A	23
MENBTR6D	23
MENBTR8(2)A	23
MENBTR8(2)D	23
MENBURR48	24
MENBURRUNIT8	24
MR75/98A08	18
MR75/98A10	18
MR75/98A12	18
MR75/98A14	18
MR75/98A16	18

MR75/98A18	18
MR75/98A20	18
MR75/98A22	18
MR75/98A24	18
MR75/98A26	18
MR75/98A28	18
MR75/98A32	18
MR75/98A36	18
MR75A08	18
MR75A10	18
MR75A12	18
MR75A14	18
MR75A16	18
MR75A18	18
MR75A20	18
MR75A22	18
MR75A24	18
MR75A26	18
MR75A28	18
MR75A30	18
MR75A32	18
MR75A34	18
MR75A36	18
MR75A40	18
MR75A44	18
MR75A48	18
MR75A56	18
MR75A64	18
MR89A14	18
MR89A16	18
MR95/12A08	19
MR95/12A10	19
MR95/12A12	19
MR95/12A14	19
MR95/12A16	19
MR95/12A18	19
MR95/12A20	19
MR95/12A22	19
MR95/12A24	19
MR95/12A26	19
MR95/12A28	19
MR95/12A30	19
MR95/12A32	19
MR95/12A36	19
MR95/12A40	19
MR95/16A08	19
MR95/16A10	19
MR95/16A12	19
MR95/16A14	19
MR95/16A16	19
MR95/16A18	19
MR95/16A20	19
MR95/16A22	19
MR95/16A24	19
MR95/16A26	19
MR95/16A28	19
MR95/16A30	19
MR95/16A32	19
MR95/16A36	19
MR95/16A40	19
MT11D	230
MT11SSD	230
MT136SSD	219
MT13GSFPD	229
MT13SSFPD	229
MT14281	221
MT142D	219
MT143D	219
MT145D	219

# INDEX - Part Number

MT145GSFP	229
MT145GSFPD	229
MT146D	219
MT155SSD	219
MT156SSD	219
MT164SSD	219
MT16533	218
MT16554	223
MT16595	218
MT165GSFP*	229
MT165SSD	219
MT166SSD	219
MT16D	220
MT17-6ASU	221
MT1790D	220
MT19/12FGXH	226
MT19087	226
MT19088	226
MT19P12XH	226
MT1D	221
MT23D	227
MT33/13FGXH	226
MT34/12FGXH	226
MT34P12XH	226
MT3508SD	223
MT35SFPD	229
MT4280D	219
MT43	220
MT43BC	220
MT4412	220
MT4419	220
MT45/6DH	227
MT4681DFDL	230
MT483CH	218
MT48DH	230
MT5206D	221
MT5208D	221
MT5769D	227
MT5788D	227
MT5D	221
MT693	221
MT6D	221
MT7374	220
MT738D	220
MT735SFPD	229
MT7588	218
MT790	218
MT7GSFP	229
MT80	222
MT81	222
MT82	222
MT829	218
MT83	222
MT841*	218
MT89	224
MTAP753F	224
MTAP753H	224
MTBJ850	222
MTBSTK12	223
MTBSTK8	223
MTCT911	227
MTFJK4HH	222
MTFJK5HH	222
MTFJK6HH	222
MTFT1245S	228
MTFT144	229
MTFT164	229
MTGF248	220
MTGTS6735	230

MTJK884D	223
MTJK886D	223
MTM5123	223
MTM5303	223
MTM5743	223
MTM5753	222
MTM5763	222
MTMXS13GSD	228
MTMXS255SD*	228
MTMXS3D	228
MTMXS355SDH	228
MTMXS66D	228
MTMXS66SSD	228
MTMXS73DH	228
MTMXS73GSD	228
MTMXS73H	229
MTMXS73SDH	228
MTMXS73SSH	228
MTMXS77DH*	228
MTNB202	224
MTPK877D	223
MTPK878D	223
MTPG525	227
MTRB852	222
MTRB854	222
MTRED700158	224
MTSK880D	223
MTSK882D	223
MTSP10GSD	230
MTSP12GSD	230
MTSP14GSD	230
MTSP16GSD*	230
MTTG51	224
MTTGL	224
MTTLW	224
MTTPSG38*	227
MTTWR19	224
PO2412800	12
PO362	11
PO3623500	12
PO3624000	12
PO362PLUS	11
PO362PLUS8	11
PO364	11
PO3643501	12
PO3644000	12
PO482	11
PO484	11
POJIG	12
POMTA	12
POP9	12
POS	10
POSPANNER	10
POTS	10
POTST	10
PRY106H4M	313
PRY106HE	313
PRY106HF	313
PRY106HH	313
PRY1122M	313
PRY112A	313
PRY112B	313
PRY112C	313
PRY112H1M	313
PRY112H2M	313
PRY112HA	313
PRY112HB	313
PRY112HC	313

PRY3000LABEL	318, 319, 320
PRYBARCODEREADER	320, 322
PRYBENCHDOT100	320
PRYBENCHDOT150	320
PRYBENCHDOT300	320
PRYFOOTSWITCH	318, 319, 320
PRYH1657	313
PRYH3220	313
PRYH63529	313
PRYH63539	313
PRYH8039	313
PRYH9640	313
PRYHN15 *	317
PRYHN15SCW	317
PRYHN15W	317
PRYHN20 *	317
PRYHN20SCW	317
PRYHN20W	317
PRYHN25 *	317
PRYHN25SCW	317
PRYHN25W	317
PRYHN30 *	317
PRYHN30SCW	317
PRYHN30W	317
PRYHN40 *	317
PRYHN40SCW	317
PRYHN40W	317
PRYHN50 *	317
PRYHN50SCW	317
PRYHN50W	317
PRYHN60 *	317
PRYHN60SCW	317
PRYHN60W	317
PRYI010 *	312
PRYI015 *	312
PRYI020 *	312
PRYI025 *	312
PRYI030 *	312
PRYI040 *	312
PRYI050 *	312
PRYI060 *	312
PRYI100 *	312
PRYIAS015	312
PRYIAS020	312
PRYIAS025	312
PRYIAS030	312
PRYIAS040	312
PRYIAS050	312
PRYIAS060	312
PRYIAS100	312
PRYINS010	312
PRYINS015	312
PRYINS020	312
PRYINS025	312
PRYINS030	312
PRYINS040	312
PRYINS050	312
PRYINS060	312
PRYINS100	312
PRYMARKMASTER 3000	321
PRYMARKMATE	318
PRYMARKMATE USB ADV	319
PRYNOS4X50	318, 319, 322

PRYNOSEPIECE100	320
PRYP010 *	314
PRYP015 *	314
PRYP015 *R	314
PRYP020 *	314
PRYP020 *R	314
PRYP025 *	314
PRYP030 *	314
PRYP030 *DS	314
PRYP030 *HD	314
PRYP030 *MS	314
PRYP030 *R	314
PRYP040 *	314
PRYP040 *R	314
PRYP050 *	314
PRYP050 *DS	314
PRYP050 *HD	314
PRYP050 *MS	314
PRYP050 *R	314
PRYP060 *	314
PRYP060 *DS	314
PRYP060 *HD	314
PRYP060 *MS	314
PRYP060 *R	314
PRYP080 *	314
PRYP080 *DS	314
PRYP080 *HD	314
PRYP100 *	314
PRYP100 *HD	314
PRYP125 *	314
PRYP125 *HD	314
PRYPAS010	315
PRYPAS015	315
PRYPAS015R	315
PRYPAS020	315
PRYPAS020R	315
PRYPAS025	315
PRYPAS030	315
PRYPAS030DS	315
PRYPAS030HD	315
PRYPAS030MS	315
PRYPAS030R	315
PRYPAS040	315
PRYPAS040R	315
PRYPAS050	315
PRYPAS050DS	315
PRYPAS050HD	315
PRYPAS050MS	315
PRYPAS050R	315
PRYPAS060	315
PRYPAS060DS	315
PRYPAS060HD	315
PRYPAS060MS	315
PRYPAS060R	315
PRYPAS080	315
PRYPAS080DS	315
PRYPAS080HD	315
PRYPAS100	315
PRYPAS100HD	315
PRYPAS125	315
PRYPAS125HD	315
PRYPNS010	316
PRYPNS015	316
PRYPNS015R	316
PRYPNS020	316
PRYPNS020R	316
PRYPNS025	316
PRYPNS030	316
PRYPNS030DS	316

# INDEX - Part Number

PRYPNS030HD	316
PRYPNS030MS	316
PRYPNS030R	316
PRYPNS040	316
PRYPNS040R	316
PRYPNS050	316
PRYPNS050DS	316
PRYPNS050HD	316
PRYPNS050MS	316
PRYPNS050R	316
PRYPNS060	316
PRYPNS060DS	316
PRYPNS060HD	316
PRYPNS060MS	316
PRYPNS060R	316
PRYPNS080	316
PRYPNS080DS	316
PRYPNS080HD	316
PRYPNS100	316
PRYPNS100HD	316
PRYPNS125	316
PRYPNS125HD	316
PRYPORTABASE	322
PRYPORTABASE130-30E	322
PRYPORTADOT 100-75 EH	322
PRYPORTADOT 50-25E	322
PRYPORTADOT130-30E	322
PRYPPG	316
PRYSTY3X100	320
PRYSTY4X50	318, 319, 322
PRYSTYSPRING3000	320
PRYSTYSPRINGMM	318
PRYSTYSPRINGMM	319, 322
QB2	26
QB3	26
QB4	26
RA1410C	255
RA312	259
RA332	258
RA3805	255
RA3810	255
RA3815	255
RA3815R	255
RA3820	255
RA3820R	255
RA3830	255
RA502	257
RA650	257
RA702A	257
RA703B	259
RA705A	258
RA811A	256
RA812A	256
RA813A	255
RA816	256
RA818	256
RA909	255
RAAC1.5/15	264
RAAC2.5/36	264
RAAC2/24	264
RAAC6.5/50P	266
RAAF3P	252
RAAF5P	252
RAAIK14P	252
RAAIK20P	252
RAATK5P	262

RAB2800/100/2.5	266
RAB2800/50/2.5	266
RAB3800/100/3	266
RAB3800/50/3	266
RABD255/100/2.5	265
RABD255/50/2.5	265
RABD265/100/3	265
RABD265/50/3	265
RABNS	259
RAC380	259
RAC681	257
RAC715	257
RAC725	258
RAC733	259
RAC734	259
RAC735	258
RAC823	255
RAC851	256
RAC856	256
RAC861	256
RACS4P	257
RACSG	260
RADBG	253
RAECG	253
RAFAF2P	252
RAFILREG	254
RAFNG	260
RAFNG	260
RAGF3K	262
RAGF4K	262
RAGFGP	261
RAGFTU	261
RAGFWS	261
RAHV-215	255
RAIGWG	253
RAINLUB	253
RAK17	257
RAK34	262
RAK50	262
RAMAF2P	252
RAMAFHT1/4	253
RAMAFHT3/8	253
RANCN65	260
RAOC1000	266
RAOT500	258
RAQC2P	254
RAQC2PF	254
RAQCHT1/4	254
RAQCHT3/8	254
RARS2P	257
RASFGP	261
RASFPQ	261
RATN64	261
RAV2.75/36	264
RAV2.75/50	264
RAV2051/100/2.5	265
RAV2051/50/2.5	265
RAV2065/100/3	265
RAV2065/50/3	265
RBC220	263
RBC320	263
RBC400	263
RBC520	263
RBC620	263
RG-18B	267
RG-21C	267
RGB18	267
RGCS38CC	263
RGCS45CC	263

RGHT18	267
RGLT18	267
RGLT530/5	267
RGPB	267
RGPH26	267
RGPLT26	267
ROM1-014980	326
ROM1-014981	326
ROM1-014984	326
ROM1-014988	326
ROM1-014991	326
ROM1-014995	326
ROM1-017003	326
ROM1-017004	326
ROM1-017005	326
ROM1-017006	326
ROM1-017007	326
ROM1-017076	326
ROM1-017077	326
ROM1-017078	326
ROM1-017079	326
ROM1-025835	326
ROM1-025839	326
ROM1-026411	326
ROM1-061671	325
ROM1-068006	326
ROM1-072628	325
ROM1-072811	325
ROM1-072815	325
ROM1-072818	325
ROM1-072827	325
ROM1-072828	325
ROM1-072829	325
ROM1-082371	325
ROM1-1014172	324
ROM1-1015995	324
ROM1-1033001	324
ROM1-1033051	324
ROM1-205989	326
ROM1-215000	325
ROM1-215001	325
ROM1-227152	325
ROM1-249804	324
ROM1-309380	326
ROM1-317257	325
ROM1-381547	325
ROM1-636614	325
ROM1-664465	324
ROM1-664466	324
ROM1-664467	324
ROM1-767554	324
ROM1-767639	324
ROM1-767657	324
ROM1-767692	324
ROM1-802490	324
ROM1-863921	324
ROM1-871015	325
ROM1-871018	325
ROM1-871044	324
ROM1-871052	324
ROM1-871054	324
ROM1-871055	324
ROM1-871066	324
RPAG750W	269
RPG2500	268
RPG3000RCD	268
RPG6250	269
RPG6250RCD	269

RPG8000RCD	269
RPG8125S	269
RPPHA150HDSA	268
RPPHA150MM	268
RPPHA150SA	268
RPPHA200MM	268
RPPHA200SA	268
RPPW1600E	270
RPPW1900	271
RPPW2000E	270
RPPW2400EH	270
RPPW2600	271
RPPW3200	271
RPPW4200	272
RPPWH5M	272
RPPWPC	270
RPPWRB	270
RPWFFK	273
RPWK1	273
RPWK2A	273
RPWK2B	273
RPWP125	272
RPWP150	272
RPWP240	272
RXC1000	276
RXC1001	276
RXC1002	276
RXC1004	277
RXC1005	277
RXC1006	277
RXC1007	277
RXC1008	274
RXC1009	274
RXC1010	274
RXC1011	279
RXC1012	277
RXC1013	277
RXC1014	276
RXC1015	276
RXC1016	277
RXC1017	276
RXC1018	276
RXC1019	276
RXC1020	274
RXC1021	274
RXC1023	278
RXC1024	278
RXC1024B	278
RXC1025	278
RXC1025B	278
RXC1026	278
RXC1026B	278
RXC1027	277
RXC1028	276
RXC1029	277
RXCART	279
RXH100F	280
RXH300S	280
RXH300SK	280
RXHH	280
RXHIL1	280
RXHIL2	280
RXHOL	280
RXT100P	275
RXT135E	274
RXT140P	274
RXT150E	274
RXT150P	275
RXT170P	274

# INDEX - Part Number

RXT175ET	276
RXT175P	275
RXT180ACDC	275
RXT180E	274
RXT200EX	275
RXT250EX	276
RXT40EP	279
RXT40EP/43	279
RXT40EP/T1	279
RXT40EP/T2	279
RXT40EP/T3	279
RXT40EP/T4	279
RXTIGTORCH	279
RXWAG	279
SDBP/2-14	50
SDCLUB/2-12	50
SDCLUB/4-12	50
SDHNDL/12	50
SDHNDL/30-60	50
SDSLDG/10-30	50
SDSLDG/10-30SF	50
SDSLDG/12-30	50
SDSLDG/12-30SF	50
SDSLDG/14-30	50
SDSLDG/14-30C	50
SDSLDG/14-30SF	50
SDSLDG/3-12C	50
SDSLDG/4-12C	50
SDSLDG/4-12SF	50
SDSLDG/4-24	50
SDSLDG/8-24	50
SDSLDG/8-24C	50
SDSLDG/8-24SF	50
SDSLDG/8-30	50
SDSLDG/8-30C	50
SDSLDG/8-30SF	50
SRARK-10K	193
SRB2124	190
SRF-1	192
SRF-3	192
SRHW105	194
SRHW105A	194
SRHW165	194
SRKP19	190
SRKP22	190
SRKP24	190
SRKP27	190
SRKP30	190
SRKP32	190
SRKP36	190
SRKP41	190
SRKP46	190
SRKP50	190
SRMWR30	194
SRMWR36	194
SRPW100	194
SRPW100/RKA	194
SRPW100/RKB	194
SRRG4	191, 193
SRRG5	191, 193
SRRG6	191, 193
SRRG8	191, 193
SRRHD7	193
SRRN1012	191
SRRN1317	191
SRRN1618	191

SRRN1719	191
SRRN1824	191
SRRN1921	191
SRRN1924R	191
SRRN2124	191
SRRN2224	191
SRRN2427	191
SRRN2430	191
SRRN2730	191
SRRN2732	191
SRRN3036	191
SRRN3236	191
SRRN3641	191
SRRN4650	191
SRRNG1924	191
SRRNG2430	191
STM4L010	14
STM4L013	14
STM4L016	14
STM4L018	14
STM4L019	14
STM4L021	14
STM4L022	14
STM4L024	14
STM4L025	14
STM4S010	14
STM4S011	14
STM4S013	14
STM4S014	14
STM4S016	14
STM4S019	14
STM4S022	14
STM4S025	14
STM6008	14
STM6010	14
STM6011	14
STM6013	14
STM6014	14
STM6016	14
STM6018	14
STM6019	14
STM6021	14
STM6022	14
STM8010	15
STM8011	15
STM8012	15
STM8013	15
STM8014	15
STM8016	15
STM8016EXL	15
STM8018	15
STM8019	15
STM8019L600	15
STM8022	15
STM8022L600	15
STM8025	15
STM8025L600	15
STM8027	15
STM8029	15
STM8032	15
STM8M010	15
STM8M011	15
STM8M012	15
STM8M013	15
STM8M014	15
STM8M016	15
STM8M018	15
STM8M019	15
STM8M022	15

STM8M025	15
STM8M029	15
STM8M032	15
SV076HSAE	199
SV2B4001	200
SV2N1030	200
SV2N1042	200
SV380SAE	199
SV600SAE	198
SV608SAE	198
SV614SAE	198
SV616SAE	198
SV620SAE	198
SV625SAE	198
SV660SAE	199
SV671SAE	199
SV676SAE	199
SV678SAE	199
SV681SAE	199
SV685SAE	200
SV712SAE	200
SV742SAE	200
SV7N1529	199
SVSC100M	198
SVSC100N	198
SVSC150M	198
SVSC150N	198
SW 010/12	66
SW 012/10	66
SW 012/15	66
SW 023/8	66
SW 4150 QR	81
SW TCS 13	68
SW10	66
SW100	124
SW102	124
SW102-5/6	125
SW10253	125
SW10356	127
SW105	125
SW10506	127
SW10518	127
SW1054	89
SW10546	115
SW1054KK	90
SW1054TX	91
SW1054x	90
SW10551	115
SW10554	115
SW105-8/6K	125
SW10670	125
SW10676	125
SW10750	74
SW10760aCV/10Pc	115
SW10760aCV/13	115
SW10760CV	116
SW10760CV/9	115
SW10765/9	115
SW10767	116
SW10767/9	116
SW10767a/13	116
SW10767a/8	116
SW10767H/9	116
SW10768	116
SW10768-2K	116
SW10769	116
SW108/6	125
SW109	125
SW10955	124

SW10955R	124
SW10960	124
SW10970	124
SW10a	66
SW110	124
SW11085	127
SW11095/13	128
SW11095/20	128
SW11097/26	128
SW112	124
SW112/1	124
SW12	69
SW12050	125
SW1225	87
SW12321	126
SW12373	128
SW12374	126
SW12375	127
SW12377	126
SW12378	126
SW12481	127
SW125070-2K	115
SW12600	127
SW12665 52	126
SW12800	126
SW12905	127
SW12910	127
SW12915	126
SW12921N	127
SW12922	127
SW12a	69
SW13	67, 68
SW13/22 TCS	67
SW13100	126
SW13110	126
SW13115	126
SW13a	67, 68
SW13a/22 TCS	67
SW14	68, 69
SW16	70
SW20	70
SW2049	84
SW2054	89
SW20543	89
SW2054TX	91
SW2054x	90
SW20a	70
SW21	71, 72
SW21TX	72
SW23	71
SW230a	71
SW24	72
SW240	72, 73
SW24a	72
SW25	73
SW25aN	73
SW27	73
SW29	73
SW29a	73
SW3045	128
SW3054	89
SW3054X	90
SW3505	92
SW39	128
SW4004	74
SW4008	82
SW400N	81
SW402	78
SW4025	74



# INDEX - Part Number

SW4026	74
SW403N	81
SW404	81
SW405	81
SW405 QR	81
SW405 W	81
SW406	81
SW407	81
SW409	82
SW409M	109
SW40aD	78
SW40aDL	78
SW40D	78
SW40D/40AD/18/5TCS	82
SW40D/9/4	82
SW40DL	78
SW40ma/25/8	82
SW40TX	79
SW410	82
SW412	82
SW413	81
SW415	80
SW4150	80
SW415QR	80
SW415SGH	82
SW415SG-QR	80
SW416	80
SW4205	75
SW422N	85
SW424	86
SW425	86
SW427	86
SW427 W	87
SW427QR	86
SW428	87
SW431	87
SW432	87
SW4350	86
SW4350 D	86
SW4350 QR	86
SW4350 SCH	86
SW435N	85
SW435QR	85
SW435SG-QR	86
SW44	79
SW44a	79
SW44CL	80
SW44K	79
SW44KTX	79
SW44KTXB	79
SW44P	80
SW45	83, 87
SW452	86
SW45a	83
SW45CL	85
SW45TX/7	84
SW46	83
SW4606	84
SW460a	83
SW4620	113
SW4622	113
SW4628	114
SW4630	114
SW4631	114
SW4632	114
SW4640	114
SW4650	114
SW4650L	114
SW4660 VDE	115

SW4665 VDE	115
SW4691	113
SW4692	113
SW4693	113
SW4694	113
SW4695 VDE	115
SW4697	113
SW4699	113
SW46a	83
SW4724	113
SW4734	114
SW4797	114
SW4820	112
SW4830	112
SW4840	112
SW4856	112
SW4891	112
SW4892	112
SW4899	112
SW49	84
SW49a	84
SW49TX	84
SW49TX/8	84
SW49X	84
SW50	88
SW50/50A/29/5TCS	93
SW500QR	81
SW504	92
SW5040	92
SW506	92
SW506QR	92
SW509	92
SW509 QR	92
SW509 W	92
SW50a	88
SW50a/17/6	93
SW51	88
SW510	93
SW510QR	93
SW512	91
SW5120 QR	92
SW5120+7210/15	91
SW512QR	91
SW512SG-QR	91
SW513	93
SW514	93
SW517	91
SW51a	88
SW54	89
SW54/10	89
SW540	85
SW54a	89
SW54CV	90
SW54KK	89
SW54TX	90
SW54TX/9	90
SW54X	90
SW55	94
SW55/10/6	95
SW552	94
SW554	94
SW556	94
SW558	94
SW55a	94
SW568	95
SW569	95
SW59	94
SW6501	118, 122

SW6529	118, 122
SW6530	118, 122
SW6534	118
SW6535	118
SW6543	121
SW6544	121
SW6545	121
SW6546	121
SW6551	119
SW6563	120
SW6564	120
SW6575	122
SW6576N	120
SW6600	119, 122
SW6602	119, 123
SW6618	119
SW6622	119, 123
SW6630	120
SW6660	120
SW6703	123
SW6704	123
SW6705	123
SW6706	123
SW70V	106
SW713R	105
SW714	97
SW721	103
SW721Nf	103
SW725QR	105
SW730	102
SW730D	99
SW730N	101
SW730NR	101
SW731/10	106
SW731/40	106
SW732/10	106
SW732/40	106
SW734	106
SW735	105
SW7350/5	86
SW7530/20	92
SW7707 W	108
SW7721	109
SW7722	109
SW7723	109
SW7724	109
SW7751	109
SW7787	109
SW882	95
SW884	95
SW886	95
SW888	95
SW905/25	126
SW906	126
SWGLOVE-L	63
SWGLOVE-M	63
SWGLOVE-XL	63
SWTCS 4820/4830	112
SWVP10/6	62
SWVP1054/4	63
SWVP10a/5	62
SWVP13/9	62
SWVP13a/7	62
SWVP14/8	62
SWVP20/5	62

SWVP2049/5	63
SWVP20a/5	62
SWVP21/4	62
SWVP21TX/4	63
SWVP24/3	63
SWVP24a/2	63
SWVP49/5	63
SWVP54/6	63
TA140/06	33
TA140/06B	33
TA140/08	33
TA140/08B	33
TA140/10	33
TA140/10B	33
TA140/10SS	33
TA140/12	33
TA140/12B	33
TA140/14	33
TA140/14B	33
TA140/6-14	33
TA140EL	33
TA180/15	34
TA180/25	34
TA180/30	34
TA180/32	34
TA191EL	33
TA53/06	33
TA53/06B	33
TA53/08	33
TA53/08B	33
TA53/10	33
TA53/10B	33
TA53/12B	33
TA53/14B	33
TA91/20	34
TA91/25	34
TA91/30	34
TAA11	33
TACOMBI	32
TACT45/08	34
TACT45/10	34
TACT60/10	34
TACT60/12	34
TACT60/14	34
TAZ1-53	32
TAZ1-53TB	32
TAZ3-140	32
TAZ3-140L	32
TAZ3-CT45	32
TAZ3-CT60	32
TH08	44
TH08R	48
TH10	44
TH108	46
TH10R	48
TH110	46
TH112	46
TH114	46
TH116	46
TH12	44
TH120	46
TH1212N	45
TH12R	48
TH14	44
TH1414N	45
TH14R	48
TH16	44
TH1616N	45
TH16FG	44

# INDEX - Part Number

TH16R	48
TH2020N	45
TH208	44
TH210	44
TH212	44
TH214	44
TH216	44
TH216FG	44
TH22	44
TH22R	48
TH308	44
TH308C	47
TH310	44
TH310C	47
TH312	44
TH312AF	47
TH312C	47
TH314	44
TH314C	47
TH316	44
TH316C	47
TH316FG	44
TH31708R	45
TH31710R	45
TH31712R	45
TH322	44
TH322C	47
TH32J612R	46
TH406	45
TH406PF	47
TH408	45
TH408PF	47
TH410	45
TH410PF	47
TH412	45
TH412PF	47
TH414	45
TH414PF	47
TH416	45
TH416PF	47
TH612HF	48
TH612SF	48
TH704	46
TH705	46
TH706	46
TH708	45
TH708NF	47
TH708TF	48
TH710	45
TH710NF	47
TH710TF	48
TH710VF	48
TH711FG	46
TH712	45
TH712NF	47
TH712TF	48
TH712VF	48
TH713FG	46
TH714	45
TH714NF	47
TH714TF	48
TH715FG	46
TH716	45
TH716NF	47
TH716TF	48
TH717FG	46
TH719FG	46
TH720	45
TH720FG	45

TH720NF	47
TH720TF	48
TH952	46
TH952FG	47
TH952W	46
TH952WFG	47
TH953	46
TH953FG	47
TH953W	46
TH953WFG	47
TH954	46
TH954FG	47
TH954W	46
TH954WFG	47
TH957	46
TH957FG	47
TH957W	46
TH957WFG	47
THH1W	48
THH2W	48
THH3W	48
THH4W	48
THH953W	48
THH954W	48
THH957W	48
THHAW	48
TR40200/27	56
TR40200/29	56
TR40400/004	56
TR40400/008	56
TR40400/012	56
TR40400/016	56
TR40400/024	56
TR40400/032	56
TR40400/040	56
TR40402/012	56
TR40503/002	56
TR40504/004	56
TR40700/027	56
TR40720/002	56
TRA380	57
TRA600	57
TRA700	57
TRA800	57
TRB1350/22	57
TRB1500/25	57
TRB1800/25	57
TRBP250	57
TRBP300	57
TRBP350	57
TRBP400	57
TRBP450	57
TRC250	57
TRC250	57
TRCDTC	234
TRCHTC	234
TRCL360	57
TRH1350	57
TRH1500	57
TRI-AJA150	245
TRI-AJA300	247
TRI-BJA300	247
TRI-BRA200	245
TRI-DCA250	245
TRI-DCA300	247
TRI-EPA001	245
TRI-ETA100	245
TRI-ETA300	245
TRI-FJA300	247
TRI-JOF001	240

TRI-MOF001	240
TRI-MSA200	250
TRI-RSA300	246
TRI-RTA300	246
TRI-SJA200	243
TRI-SJA420	243
TRI-SJA460	243
TRI-SJA470	243
TRI-T12HCB	249
TRI-T12ID020	249
TRI-T12TP	249
TRI-TA1200BS	241
TRI-TCMBS	241
TRI-TGA150	240
TRI-TRA001	240
TRI-TSA001	242
TRI-TSP5450	242
TRI-TSS100G	242
TRI-TSS150G	242
TRI-TSS240G	242
TRI-TSS60G	242
TRI-TSS80G	242
TRI-TTS1400P	248
TRI-WCA201	244
TRI-WCA390	245
TRI-WRA001	250
TRMP900	57
TRR1350/25	57
TRR1500/25	57
TRR1500/29	57
TRS600	57
TRS750	57
TRS900	57
TRSD670	57
TRSLB1300	57
TRU2600	233
TRU3602-001TC	233
TRU3602-001TG	233
TRU3602-192TC	233
TRU3602-192TG	233
TRU3602-193TC	233
TRU3602-193TG	233
TRU4HT600	234
TRU5000	232
TRU5061	233
TRU5500	232
TRU5500E	232
TRUC1862-1	233
TRUC2626-1	233
TRUC7574-1	233
TRUC7905-1	233
TRUD5697-1	233
TRUD5697-3	233
TRWS750	57
TRWS900	57
TW122159	290
TW322051	290
TW802029	291
TW802255	290
TW802256	290
TW802257	290
TW802258	291
TW802259	291
TW802260	291
TW802517	290
TW802527	290
TW802528	290
TW802529	290
TW802530	290

TW803152	291
TW803153	291
TW803154	291
TWAUTOTRONIC25	288
TWDIGITALMOD230	291
TWDYNAMIC320	289
TWDYNAMIC520	289
TWDYNAMIC620	290
TWLEADER220	289
TWLEADER400	289
TWMODULAR20/TI	291
TWNEVABOOST100	288
TWNEVABOOST140	288
TWNEVADA11	288
TWNEVADA14	289
TWNEVADA15	289
TWNEVATRONIC12	288
TWNEVATRONIC24	288
VB524205	196
VB531620	196
VB532125	196
VB533660	196
VB545315	196
VB587225	196
VB588215	196
VB588220	196
VB777	196
VB80P	196
VM35HOSE	310
VM64HOSE	310
VM950072	309
VM950108	310
VM9501100	310
VM950111	309
VM950126	309
VM950130	309
VM950131	309
VM950134	310
VM950136	309
VM950137	309
VM950175	309
VM950200	310
VMAT-18D	309
VMBLUEFILTER	309
VMCARTFILTER	310
VMFOAMFILTER	309
VMFV5801.01.00	310
VMFV9563.01.00	310
VMFV9612.01.00	309
VMFV9612.02.00	309
VMFV9615.01.00	309
VMFV9644.04.00	310
VMV3MK	309
VMVF1515HJ	308
VMVHBL	309
VMVK1520SIW	308
VMVK1650SWDC	308
VMVK1660SWDC	309
VMVQ1215P	308
VMVQ1220SS	308
VMVQ1530SWDC	308
VMVRC2	309
WHI-12BARPG	297
WHI491B	331
WHI496B	331
WHI503B	328
WHI505B	329
WHI507B	329
WHI508B	328

# INDEX - Part Number

WHI509B	328
WHI510B	328
WHI510BP-B5	338
WHI514B	329
WHI518	332
WHI620	330
WHI621	330
WHI-6BARPG	297
WHI753B	331
WHI880B	331
WHIBFC111	338
WHIBFC500D	338
WHIBFC753	338
WHIBL400	338
WHIBL500	338
WHIBL500B	338
WHIBL505	338
WHIBL505B	338

WHIBL600	338
WHIBL700	338
WHIBL800	338
WHIBL900B	338
WHIBLUPTB1220R	338
WHIBSC111	338
WHIBSC500	338
WHIBSC500D	338
WHIBSC880	338
WHIBSCM880	338
WHIBSLIDE10	338
WHIBSLIDE10B	338
WHIBSLIDE12	338
WHIBSLIDE14B	338
WHIBSLIDE16	338
WHIBSLIDE20	338
WHIC56-9B	329
WHICSPARE SWIVEL	338

WHIPCRE1754	334
WHIPCRE3003	334
WHIPCRE4005	334
WHIPCRE604B	334
WHI-PIGGYBACKFLOAT	297
WHIPMT111	333
WHIPTC106	333
WHI-PUMPCOVER	297
WHISB445	335
WHISB565	335
WHISB700	335
WHISB850	335
WHISB-CASTORSET	335
WHISC6600	334
WHISH880	338
WHISHROLLCAB	338
WHISL-402	332
WHISL-408	332

WHIT400DR	330
WHIT700B	332
WHITB100	330
WHITB10C	336
WHITB10D	337
WHITB200	330
WHITB20C	336
WHITB20D	337
WHITB30C	336
WHITB30D	337
WHITB30DG20DG	337
WHITB40C	336
WHITB40D	337
WHITB500	330
WHITL10/20C	338
WHITL30/40C	338
WHIUPTB1220R	336
WHIUPTB900	336

# NOTES

# NOTES

# NOTES

# NOTES

# Terms & Conditions

## 1. QUOTATION AND FORWARD ORDERS

- 1.1 No quotation given by the Company shall constitute or be deemed to constitute a binding offer and a valid contract shall only exist after the Company's written acceptance of an order (whether by issue of the Company's standard invoice/ statement or otherwise). Such contract shall be subject to the conditions set out below.
- 1.2 Where goods have to be ordered from overseas the Company shall not be liable to the Purchaser for such an order unless and until the Manufacturer communicates its acceptance of such an order to the Company.
- 1.3 A quotation is valid for thirty (30) days only and the Company reserves the right to amend it if an error or omission has occurred.

## 2. DESCRIPTION OF GOODS

- 2.1 Weights and/or dimensions included in any catalogues, advertisements, illustrated matter and price lists are approximates only and details thereof shall not be binding unless and to the extent only that such details are specified in the contract.
- 2.2 Technical documents or drawings submitted to the Purchaser prior to a contract being entered into remain the property of the Company and shall not be copied reproduced or used by manufacturers or transmitted to a third party unless the prior written permission of the Company is obtained.
- 2.3 One copy of the technical data operator's handbook and spare parts list where applicable and subject to availability will be supplied by the Company to the Purchaser without charge at the time of delivery (or if unavailable, when available). Further copies shall be at the cost of the Purchaser.

## 3. WARRANTIES

- 3.1 Subject to the provisions of the contract all and any terms conditions and warranties or representations expressed or implied whether statutory or otherwise collateral or antecedent hereto or otherwise with respect to the merchantability quality condition fitness durability suitability of the goods ordered in any respect (except those expressly contained herein or incorporated herein by reference or otherwise expressly agreed to in writing by the Company) are to the extent that the same may be excluded, hereby expressly negated and excluded.
- 3.2 The Purchaser shall satisfy itself as to the condition quality and suitability of the goods and the fitness of the goods for the purpose(s) for which the goods are being purchased and as to its compliance with the description (if any) of such goods. Any description shall be by way of identification only and the use of such description shall not constitute this contract sale by description.
- 3.3 The Company shall not, after delivery of the goods to the Purchaser, be responsible or liable (in the absence of any wilful or negligent act or omission on the part of the Company) for any liability claim loss damage or expense of any kind or nature (including but not limited to loss of profits earnings or income direct indirect consequential contingent or resulting liability loss or damage whether to persons property or otherwise) or death or injury caused by or arising out of or relating in any manner or incidental to the goods or the possession or use thereof by the Purchaser or any third party or in relation to the condition storage supply non supply performance or non-performance inadequacy in or any defect or breakdown of any accident to the goods or any item therein or anything or service provided for or contemplated by or incidental to or arising out of the distribution sale promotion display or advertisement of the goods hereunder. The Purchaser shall and does hereby release and discharge the Company from any liability in respect of any action proceeding demand claim loss damage expense death injury aforesaid.
- 3.4 In circumstances where the Purchaser is a "consumer" as defined for the purposes of Division 1 in Part 3.2 of Schedule 2 to the Competition and Consumer Act 2010 (Cth) (the Australian Consumer Law) ("the Australian Consumer Law"), these conditions of sale shall not be read or applied so as to purport to exclude restrict or modify or have the effect of excluding restricting modifying the application of the consumer guarantees set out in the Australian Consumer Law. All other conditions or warranties which would or might otherwise be implied and are hereby expressly excluded and negated.
- 3.5 If the Purchaser is a "consumer" for the purposes of the Australian Consumer Law, then to the extent permitted under the Australian Consumer Law the Company's liability for a breach of the consumer guarantees set out in the Australian Consumer Law including any consequential loss which the Purchaser or any third party may sustain or incur shall be limited, at the option of the Company, to:
  - (i) the replacement or repair of the goods concerned or the supply of equivalent goods; or
  - (ii) the payment of the cost of replacing or repairing the goods or of acquiring equivalent goods, whichever, may be determined in the absolute discretion of the Company to be appropriate in the circumstances. The Purchaser shall within

thirty (30) days of the Purchaser first becoming aware of the facts giving rise to a claim under this provision make written claim to the Company setting out the full particulars of such claim and deliver freight prepaid to the Company the subject good(s) so as to enable the Company to examine the same and satisfy itself as to the subject claim.

- 3.6 The Company warrants that in the event of any defect being discovered within any warranty period granted by the Manufacturer of the subject goods or any component part or parts thereof the Company will, provided that it is satisfied that the defect is due to an inherent defect of faulty material or bad workmanship, repair or replace the defective part of the goods (as the Company shall in its absolute discretion determine) without charge upon the defective goods being returned freight prepaid to the Company. Any claim under this warranty must be made to the Company in writing within thirty (30) days of the defect being discovered.
- 3.7 The benefits of any warranty herein contained shall not apply in the case of:
  - (i) defect(s) due to misuse or neglect.
  - (ii) goods, which have been altered or added to or otherwise modified without the prior written consent of the Company.
  - (iii) goods repaired or serviced by any person other than the Company or its duly authorised representative.
  - (iv) goods used for purposes other than those for which they were designed as defined and/or specified in the Manufacturer's and/or the Company's catalogues, advertisements, operator's handbooks, and technical data.
- 3.8 If the goods are deemed to be non warranty, the purchaser will be advised of a repair cost and has 14 days to respond. If after 14 days no response has been received the goods will be returned to the purchaser at their cost.

## 4. SELLING PRICE

- 4.1 The selling price dated on the Company's invoice to the Purchaser is based upon the Manufacturer's then current selling price to the Company, the then current freight rates, customs duty, landing clearing and storage charges, insurance and foreign exchange rates. Should there be any variation in any of these rates or charges or if there is any variation as a result of, or changes in, the laws or regulations for the time being in force (whether State or Commonwealth) at or before the goods are delivered to or collected by the Purchaser (as the case maybe) then, in such event, the Company reserves the right to vary the selling price, including the profit margin of the Company as shall be appropriate in the circumstances and the Purchaser agrees to pay any such varied selling price in lieu of the original selling price.

## 5. DELIVERY

- 5.1 Unless otherwise agreed the delivery period shall run from the latest of the following dates.
    - (a) Acceptance of the order by the Company.
    - (b) The date upon which the Manufacturer receives notice of a Valid Import Licence.
    - (c) The date of receipt by the Company of any advance payment or Letters of Credit as may be stipulated in the contract.
    - (d) The date of receipt by the Manufacturer of a final order from the Company for the Manufacturer to commence manufacture of the subject goods.
    - (e) Standard pack quantities may apply.
    - (f) All deliveries must be signed for upon receipt
    - (g) All damaged goods must be identified upon receipt of the delivery, and the damage noted on the connote. Any damages must be reported to our Customer service team within 48 hours, and no claims will be accepted outside of our normal notification terms.
- White International will not cover any damage or loss incurred after a delivery has been made to an on-forwarder, or a purchasers designated carrier. It is the purchasers responsibility to ensure that damages etc are reported by their carriers.

## 6. DELAY IN DELIVERY

- 6.1 No liability shall be attached to the Company for deliveries delayed, suspended, cancelled, part or short delivered due to an Act of God, war, riot, fire explosion, accident, flood, shortage, inability to obtain fuel, power, raw materials, labour, containers, or transportation facilities, government law, regulations, orders or action, breakage or failure of machinery or apparatus, national defence requirements or any other event beyond the reasonable control of the Company or in the event of labour trouble, strike, lockout or injunction (whether or not such labour event prevents the manufacture, shipment acceptance of a shipment of the goods or of material upon which the manufacturer of the goods is dependent.





## WHITE INTERNATIONAL PTY LTD

52-60 Ashford Ave Milperra NSW 2214  
PO Box 304 Milperra LPO NSW 2214  
Phone 02 9783 6000 Fax 02 9783 6001  
Customer Service Hotline 1300 780 876  
Email Sales: sales@whiteint.com.au  
General info: info@whiteint.com.au  
[www.whiteint.com.au](http://www.whiteint.com.au)



*Disclaimer: Every effort has been made to publish the correct details in this catalogue.  
No responsibility will be taken for errors, omissions or changes.*